



INTERPUMP

FLUID SOLUTIONS 

Powered by I.M.M. Hydraulics

Stainless Steel Fittings

2024

Stainless Steel Fittings

Standard Stainless Steel Fittings

Interlock Stainless Steel Fittings

Standard Stainless Steel Fittings





X001C



Swaged Ferrule (no skive)

8

X002Z



Swaged Ferrule (no skive)

9



X0009



Swaged Ferrule (skive)

10



X0007



Swaged Ferrule (no skive)

10

X0008



Swaged Ferrule (no skive)

11



X0003



Swaged Ferrule (no skive)

11



XPTFE



Ferrule for PTFE hose

12

XPTFE-C



Ferrule for PTFE hose

12



X0345



BSP Male - Flat Seat

13

X0061



BSP Female Flat Seat Rolled Nut

14

X0062



BSP Female Flat Seat Slip on Nut

14

X0161



BSP 90° Swept elbow flat seat

15

X0162



BSP 90° Swept elbow flat seat

15



X0350



BSP Male Parallel 60° cone

16

X0051



BSP Female 60° Cone - Rolled Nut

17

X0052



BSP Female 60° Cone Slip On Nut

17

X0151



BSP 90° Swept Elbow 60° Cone - Rolled Nut

18

X0152



BSP 90° Swept elbow 60° cone Slip On Nut

18

X0251



BSP 45° Swept Elbow 60° Cone Rolled nut

19

X0252



BSP 45° Swept Elbow 60° Cone Slip On Nut

19



X0360



BSP Taper Male 60° cone

20



X0370



NPTF Male 60° cone

21



X0850



JIC Male 74° cone

22

X0901



JIC Female 74° cone - Rolled Nut

23

X0902



JIC Female 74° - Slip on nut

23

X0951



JIC 90° Swept Elbow 74° Cone Rolled Nut

24

X0952



JIC 90° Swept Elbow 74° cone - Slip on nut

24

X1001



JIC 45° Swept Elbow 74° Cone Rolled Nut

25

X1002



JIC 45° Swept Elbow 74° Cone Slip On Nut

25



X0500



Metric Male 24° Seat Light

26

X0085



Metric Female 24° Seat Light

27

X0185



90° Metric Swept Elbow 24° Seat Light

28

X0285



45° Metric Swept Elbow 24° Seat Light

29



X0450



Metric Male 24° Seat Heavy

30

X0084



Metric Female 24° Seat Heavy

31

X0184



90° Metric Swept Elbow 24° Seat Heavy

32

X0284



45° Metric Swept Elbow
24° Seat Heavy

33



X0035



Metric Female 24° Seat
Light Multiseal

34

X0135



90° Metric Swept Elbow
24° Seat Light Multiseal

34

X0235



45° Metric Swept Elbow
24° Seat Light Multiseal

35



X0550



Metric Standpipe

36

X0650



90° Metric Standpipe

37

X0750



45° Metric Standpipe

38



XS350



ORFS Male

39

XS050



ORFS Female

40

XS150



ORFS 90° Swept Elbow

41

XS250



ORFS 45° Swept Elbow

42



X1350



Metric Banjo

43

X1400



BSP Banjo

43

X1600



Double BSP Perforated Bolt

44

X1600-00



BSP Perforated Bolt

44

X1650



Metric perforated bolt

45



X1260



Straight SAE Flange 3000 PSI

46

X1060



90° SAE Flange 3000 PSI

47

X1160



45° SAE Flange 3000 PSI

48

XS003



Cut Split Flanges - 3000 psi

49

XSI03



Uncut Split Flanges - 3000 psi

49



X1310



Straight SAE Flange 6000 PSI

50

X1110



90° SAE Flange 6000 PSI

51

X1210



45° SAE Flange 6000 PSI

52

XS006



Cut Split Flanges - 6000 psi

52

XSI06



Uncut Split Flanges - 6000 psi

53



XFK50



K' Female

53



XD050



Hose Junction

54



XRPF



Swivel Flange End Fitting
PN6/10/16

55

XFLG



EN Flanges Sliding
planes

56

X001C

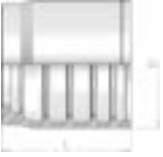

Swaged Ferrule (no skive)

Product number	hose I.D.		I.D.		Dimension		skive	valid for
	in	mm	D	L	Length	-		
X001C-03	3/16	4,8	18.5	24	NO	R17-25C-15N-Pilot-H1		
X001C-04	1/4	6.4	20	26	NO	R17-25C-15C-15N-Pilot-H1		
X001C-05	5/16	7.9	22	28	NO	R17-25C-15C-15N-Pilot-H1		
X001C-06	3/8	9.5	25	28	NO	R17-25C-15C-15N-Pilot-H1		
X001C-08	1/2	12.7	28	28	NO	R17-25C-15C-15N-Pilot-H1		
X001C-10	5/8	15.9	32	31	NO	R17-25C-15C-15N-H1		
X001C-12	3/4	19	36	38	NO	R17-25C-15C-15N-H1		
X001C-16	1	25.4	44	47.5	NO	R17-25C-15C-15N-H1		
X001C-20	1.1/4	31.8	54	56	NO	15N-25C-15C		
X001C-24	1.1/2	38.1	61.6	66	NO	15N-25C-15C		
X001C-32	2	50.8	75.4	73	NO	15N-25C-15C		
X001C-40	2.1/2	63,5	88.4	80	NO	25C-15C		
X001C-48	3	76,2	100.5	90	NO	25C-15C		

X0022**Swaged Ferrule (no skive)**

Product number	hose I.D.	Dimension		I.D.	skive	valid for
	in	D	mm	L	Length	-
X0022-03	3/16	21	4.8	25.3	NO	25N-(15N)
X0022-04	1/4	22	6.4	28	NO	25N-(15N)
X0022-05	5/16	24	7.9	28	NO	25N-(15N)
X0022-06	3/8	26	9.5	28	NO	25N-(15N)
X0022-08	1/2	30	12.7	31	NO	25N-(15N)
X0022-10	5/8	34	15.9	31	NO	25N-(15N)
X0022-12	3/4	38	19	38.5	NO	25N-(15N)
X0022-16	1	47	25.4	48	NO	25N-(15N)
X0022-20	1.1/4	58	31.8	56	NO	25N-(15N)
X0022-24	1.1/2	66	38.1	66	NO	25N-(15N)
X0022-32	2	79	50.8	73	NO	25N-(15N)

X0009

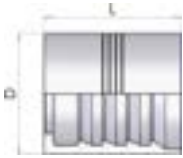

Swaged Ferrule (skive)

Product number	hose I.D.	Dimension		I.D.	skive	valid for
	in	D	mm	L	Length	
X0009-04	1/4	21	6.4	30	22	4SP-R12
X0009-06	3/8	25.4	9.5	33.5	26	4SP-R12
X0009-08	1/2	30	12.7	36	28	4SP-R12
X0009-10	5/8	34	15.9	40	31	4SP-R12
X0009-12	3/4	38	19	43	34	4SP-(R12-4SH)
X0009-16	1	46	25.4	60	48	(4SP-R12)
X0009-20	1.1/4	56	31.8	66	54	(4SP-R12)
X0009-24	1.1/2	67	38.1	76.5	62	(4SP-R12)
X0009-32	2	80	50.8	79.8	64	4SP

X0007

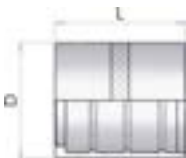

Swaged Ferrule (no skive)

Product number	hose I.D.	Dimension		I.D.	skive	valid for
	in	D	mm	L	Length	
X0007-03	3/16	14	4.8	27	NO	R7-R6-1TE-2TE
X0007-04	1/4	17	6.4	29	NO	R7-R6-1TE-2TE
X0007-05	5/16	19	7.9	30	NO	R7-R6-1TE-2TE
X0007-06	3/8	21	9.5	31	NO	R7-R6-1TE-2TE
X0007-08	1/2	25.4	12.7	34	NO	R7-R6-1TE-2TE
X0007-10	5/8	28.5	15.9	36	NO	R7-R6-1TE-2TE
X0007-12	3/4	32	19	36	NO	R7-R6-1TE-2TE
X0007-16	1	40	25.4	50	NO	R7-R6-1TE-2TE

X0008

Swaged Ferrule (no skive)

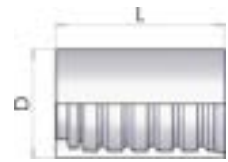

Product number	hose I.D.	Dimension		I.D.	skive	valid for
	in	D	mm	L	Length	-
X0008-03	3/16	13	4.8	25	NO	R8
X0008-04	1/4	17	6.4	29	NO	R8
X0008-05	5/16	19	7.9	30	NO	R8
X0008-06	3/8	21.5	9.5	31	NO	R8
X0008-08	1/2	26	12.7	34	NO	R8
X0008-10	5/8	29	15.9	40	NO	R8
X0008-12	3/4	32	19	42	NO	R8
X0008-16	1	40	25.4	50	NO	R8

X0003

Swaged Ferrule (no skive)



Product number	hose I.D.	I.D.	Dimension		skive	valid for
	in	mm	D	L	Length	-
X0003-03	3/16	4.8	14	27	NO	R3-3TE-R5
X0003-04	1/4	6.4	19	29	NO	R3-3TE-R5
X0003-05	5/16	7.9	22	30	NO	R3-3TE-R5
X0003-06	3/8	9.5	24	31	NO	R3-3TE-R5
X0003-08	1/2	12.7	28.5	34	NO	R3-3TE-R5
X0003-10	5/8	15.9	32	36	NO	R3-3TE-R5
X0003-12	3/4	19	38	42	NO	R3-3TE-R5
X0003-16	1	25.4	46	50	NO	R3-3TE
X0003-20	1.1/4	31.8	52	57	NO	R3-3TE

XPTFE

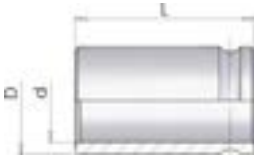

Ferrule for PTFE hose

Product number	hose I.D.	Dimension			I.D.	skive	valid for
	in	D	mm	L	d-int	Length	-
XPTFE-04	1/4	14.4	6.4	23.9	11.1	NO	PTFE type T1
XPTFE-05	5/16	17.1	7.9	24.6	13	NO	PTFE type T1
XPTFE-06	3/8	19	9.5	27.4	15	NO	PTFE type T1
XPTFE-08	1/2	22.4	12.7	28.7	18.3	NO	PTFE type T1
XPTFE-10	5/8	27	15.9	31.7	23.1	NO	PTFE type T1
XPTFE-12	3/4	28.7	19	34.5	24.8	NO	PTFE type T1
XPTFE-16	1	38.1	25.4	43.6	34.3	NO	PTFE type T1

For PTFE hose type T1 - (with standard fittings)

XPTFE-C

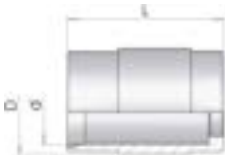

Ferrule for PTFE hose

Product number	hose I.D.	Dimension			I.D.	skive	valid for
	in	D	mm	L	d-int	Length	-
XPTFE-04-C	1/4	17.8	6.4	26.5	14.4	NO	PTFE type LTC
XPTFE-06-C	3/8	20	9.5	30.5	16.8	NO	PTFE type LTC
XPTFE-08-C	1/2	24	12.7	33.2	20.5	NO	PTFE type LTC
XPTFE-10-C	5/8	29.2	15.9	34.8	25.4	NO	PTFE type LTC
XPTFE-12-C	3/4	31.1	19	40.9	27.4	NO	PTFE type LTC
XPTFE-16-C	1	38.5	25.4	47	34.7	NO	PTFE type LTC

For PTFE hose type LTC - (with standard fittings)

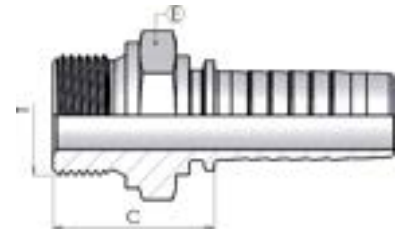
X0345**BSP Male - Flat Seat****(AGR-F)**

Product number	hose I.D.	Dimension				I.D.
	in	dash size	mm	T	E	Cut-off C
X0345-04-04	1/4	04	6.4	1/4-19	19	27
X0345-05-06	5/16	05	7.9	3/8-19	22	28
X0345-06-06	3/8	06	9.5	3/8-19	22	29
X0345-08-08	1/2	08	12.7	1/2-14	27	33
X0345-08-10	1/2	08	12.7	5/8-14	30	35
X0345-10-10	5/8	10	15.9	5/8-14	30	35
X0345-10-12	5/8	10	15.9	3/4-14	32	35
X0345-12-12	3/4	12	19	3/4-14	32	36
X0345-12-16	3/4	12	19	1-11	41	39
X0345-16-16	1	16	25.4	1-11	41	40

X0061

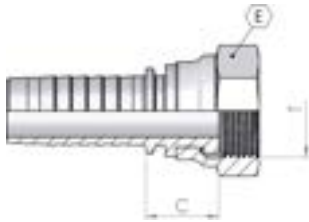

X0062

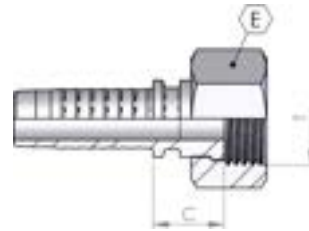

BSP Female flat seat

(DKR-F)

Product number	hose I.D.	I.D.	Dimension			
	in	mm	dash size	T	E	Cut-off C
X0062-04-04	1/4	6.4	04	1/4-19	19	14
X0062-04-06	1/4	6.4	04	3/8-19	22	15
X0062-05-06	5/16	7.9	05	3/8-19	22	15
X0062-06-06	3/8	9.5	06	3/8-19	22	15
X0062-06-08	3/8	9.5	06	1/2-14	27	16
X0062-08-08	1/2	12.7	08	1/2-14	27	16
X0061-08-12	1/2	12.7	08	3/4-14	32	23
X0061-10-12	5/8	15.9	10	3/4-14	32	20
X0061-12-12	3/4	19	12	3/4-14	32	21
X0061-12-16	3/4	19	12	1-11	38	23
X0061-16-16	1	25.4	16	1-11	38	22
X0061-20-20	1.1/4	31.8	20	1.1/4-11	50	25
X0061-24-24	1.1/2	38.1	24	1.1/2-11	55	27

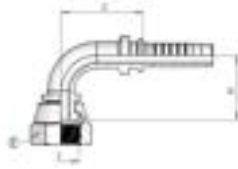
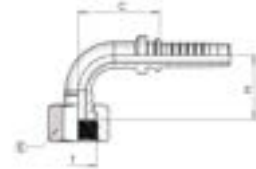
X0161**X0162****Curva BSP 90° Sede Piana****(DKR-90°)**

Product number	hose I.D.	I.D.	Dimension				
	in	mm	dash size	T	E	H	Cut-off C
X0162-04-04	1/4	6.4	04	1/4-19	19	20	27
X0162-08-08	1/2	12.7	08	1/2-14	27	37.5	38.5
X0161-12-12	3/4	19	12	3/4-14	32	57	56
X0161-12-16	3/4	19	12	1-11	38	56	56
X0161-16-16	1	25.4	16	1-11	38	67	70
X0161-20-20	1.1/4	31.8	20	1.1/4-11	50	84	83
X0161-24-24	1.1/2	38.1	24	1.1/2-11	55	95	103

X0350

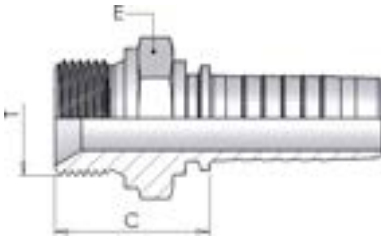

BSP Male Parallel 60° cone

(AGR)

Product number	hose I.D.	I.D.	Dimension			
	in	mm	dash size	T	E	Cut-off C
X0350-03-02	3/16	4.8	03	1/8-28	14	21
X0350-03-04	3/16	4.8	03	1/4-19	19	26
X0350-04-02	1/4	6.4	04	1/8-28	14	21
X0350-04-04	1/4	6.4	04	1/4-19	19	27
X0350-04-06	1/4	6.4	04	3/8-19	22	28
X0350-05-04	5/16	7.9	05	1/4-19	19	27
X0350-05-06	5/16	7.9	05	3/8-19	22	28
X0350-06-04	3/8	9.5	06	1/4-19	19	27
X0350-06-06	3/8	9.5	06	3/8-19	22	29
X0350-06-08	3/8	9.5	06	1/2-14	27	32
X0350-08-06	1/2	12.7	08	3/8-19	22	29
X0350-08-08	1/2	12.7	08	1/2-14	27	33
X0350-08-12	1/2	12.7	08	3/4-14	32	35
X0350-10-08	5/8	15.9	10	1/2-14	27	33
X0350-10-10	5/8	15.9	10	5/8-14	30	35
X0350-10-12	5/8	15.9	10	3/4-14	32	35
X0350-12-12	3/4	19	12	3/4-14	32	36
X0350-12-16	3/4	19	12	1-11	41	39
X0350-16-16	1	25.4	16	1-11	41	40
X0350-16-20	1	25.4	16	1.1/4-11	50	44
X0350-20-20	1.1/4	31.8	20	1.1/4-11	50	45
X0350-20-24	1.1/4	31.8	20	1.1/2-11	55	46
X0350-24-24	1.1/2	38.1	24	1.1/2-11	55	46
X0350-32-32	2	50.8	32	2-11	70	54

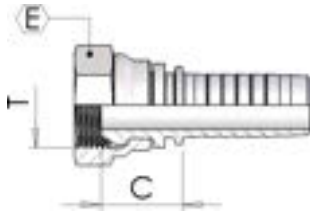
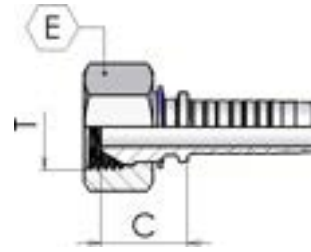
X0051**X0052****BSP Female 60° Cone****(DKR)**

Product number	hose I.D.		Dimension			
	in	mm	dash size	Thread T	hex E	Cut-off C
X0051-03-02	3/16	4.8	03	1/8-28	14	15
X0052-03-04	3/16	4.8	03	1/8-28	14	17
X0051-04-02	1/4	6.4	04	1/8-28	14	15
X0052-04-04	1/4	6.4	04	1/4-19	19	21
X0052-04-06	1/4	6.4	04	3/8-19	22	21
X0051-05-04	5/16	7.9	05	1/4-19	19	17
X0052-05-06	5/16	7.9	05	3/8-19	22	21
X0051-06-04	3/8	9.5	06	1/4-19	19	17
X0052-06-06	3/8	9.5	06	3/8-19	22	21
X0052-06-08	3/8	9.5	06	1/2-14	27	23
X0051-08-06	1/2	12.7	08	3/8-19	22	20
X0052-08-08	1/2	12.7	08	1/2-14	27	23
X0051-08-10	1/2	12.7	08	5/8-14	30	20
X0051-08-12	1/2	12.7	08	3/4-14	32	27
X0051-10-08	5/8	15.9	10	1/2-14	27	23
X0051-10-10	5/8	15.9	10	5/8-14	30	20
X0051-10-12	5/8	15.9	10	3/4-14	32	25
X0051-12-12	3/4	19	12	3/4-14	32	25
X0051-12-16	3/4	19	12	1-11	38	26
X0051-16-12	1	25.4	16	3/4-14	32	27
X0051-16-16	1	25.4	16	1-11	38	27
X0051-16-20	1	25.4	16	1.1/4-11	50	30
X0051-20-20*	1.1/4	31.8	20	1.1/4-11	50	32
X0051-20-24*	1.1/4	31.8	20	1.1/2-11	55	34
X0051-24-24*	1.1/2	38.1	24	1.1/2-11	55	34
X0051-32-32*	2	50.8	32	2-11	70	31

*with o'ring

X0151

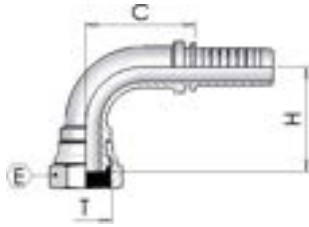

X0152

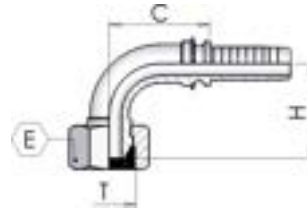

BSP 90° Swept elbow 60° cone

(DKR-90°)

Product number	hose I.D.		Dimension				
	in	mm	dash size	T	E	H	C
X0151-03-02	3/16	4.8	03	1/8-28	14	23	22
X0152-03-04	3/16	4.8	03	1/4-19	19	25	22
X0151-04-02	1/4	6.4	04	1/8-28	14	25	25
X0152-04-04	1/4	6.4	04	1/4-19	19	21	27
X0152-04-06	1/4	6.4	04	3/8-19	22	24	27
X0151-05-04	5/16	7.9	05	1/4-19	19	31	30
X0151-06-04	3/8	9.5	06	1/4-19	19	34	30
X0152-06-06	3/8	9.5	06	3/8-19	22	29	33
X0152-06-08	3/8	9.5	06	1/2-14	27	31	36
X0151-08-06	1/2	12.7	08	3/8-19	22	42	39
X0152-08-08	1/2	12.7	08	1/2-14	27	41	39
X0151-08-10	1/2	12.7	08	5/8-14	30	41	40
X0151-08-12	1/2	12.7	08	3/4-14	32	46	41
X0151-10-10	5/8	15.9	10	5/8-14	30	53	42
X0151-10-12	5/8	15.9	10	3/4-14	32	50	45
X0151-12-12	3/4	19	12	3/4-14	32	57	56
X0151-12-16	3/4	19	12	1-11	38	56	56
X0151-16-16	1	25.4	16	1-11	38	67	70
X0151-16-20*	1	25.4	16	1.1/4-11	50	72	70
X0151-20-20*	1.1/4	31.8	20	1.1/4-11	50	84	83
X0151-24-24*	1.1/2	38.1	24	1.1/2-11	55	95	103
X0151-32-32*	2	50.8	32	2-11	70	124	133

*with o'ring

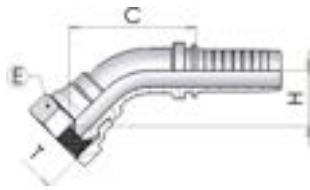
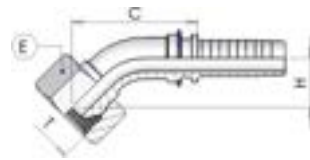
X0251**X0252****BSP 45° Swept Elbow 60° Cone****(DKR-45°)**

Product number	hose I.D.		dash size	Dimension			
	in	mm		T	E	Cut-off C	H
X0252-03-04	3/16	4.8	03	1/4-19	19	35	15
X0251-04-02	1/4	6.4	04	1/8-28	14	40	14
X0252-04-04	1/4	6.4	04	1/4-19	19	41	15
X0252-04-06	1/4	6.4	04	3/8-19	22	44	18
X0251-05-04	5/16	7.9	05	1/4-19	19	47	16
X0252-05-06	5/16	7.9	05	3/8-19	22	51	19
X0251-06-04	3/8	9.5	06	1/4-19	19	50	16
X0252-06-06	3/8	9.5	06	3/8-19	22	51	19
X0252-06-08	3/8	9.5	06	1/2-14	27	55	21
X0251-08-06	1/2	12.7	08	3/8-19	22	63	22
X0252-08-08	1/2	12.7	08	1/2-14	27	63	22
X0251-10-10	5/8	15.9	10	5/8-14	30	68	23
X0251-10-12	5/8	15.9	10	3/4-14	32	72	27
X0251-12-12	3/4	19	12	3/4-14	32	86	30
X0251-12-16	3/4	19	12	1-11	38	88	32
X0251-16-16	1	25.4	16	1-11	38	107	35
X0251-20-20*	1/1.4	31.8	20	1/1.4-11	50	106	40
X0251-24-24*	1/1.2	38.1	24	1/1.2-11	55	117	51
X0251-32-32*	2	50.8	32	2-11	70	146	59

*with o'ring

X0360

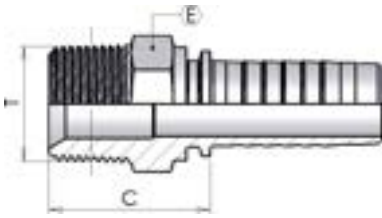

BSP Taper Male 60° cone

(AGR-K)

Product number	hose I.D.		I.D.	Dimension		
	in	mm		dash size	T	E
X0360-04-02	1/4	6.4	04	1/8-28	12	22
X0360-04-04	1/4	6.4	04	1/4-19	15	28
X0360-04-06	1/4	6.4	04	3/8-19	19	28
X0360-05-04	5/16	7.9	05	1/4-19	15	28
X0360-05-06	5/16	7.9	05	3/8-19	19	28
X0360-06-04	3/8	9.5	06	1/4-19	17	28
X0360-06-06	3/8	9.5	06	3/8-19	19	28
X0360-06-08	3/8	9.5	06	1/2-14	22	33
X0360-08-06	1/2	12.7	08	3/8-19	19	29
X0360-08-08	1/2	12.7	08	1/2-14	22	34
X0360-10-08	5/8	15.7	10	1/2-14	24	34
X0360-10-12	5/8	15.7	10	3/4-14	27	36
X0360-12-12	3/4	19	12	3/4-14	27	37
X0360-12-16	3/4	19	12	1-11	36	43
X0360-16-16	1	25.4	16	1-11	36	44
X0360-20-20	1.1/4	31.8	20	1.1/4-11	46	47
X0360-24-24	1.1/2	38.1	24	1.1/2-11	50	49
X0360-32-32	2	50.8	32	2-11	65	55

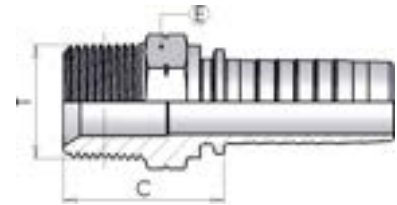
X0370**NPTF Male 60° cone****(AGN)**

Product number	hose I.D.		Dimension			
	in	mm	dash size	Cut-off C	T	E
X0370-03-04	3/16	4.8	03	27	1/4-18	15
X0370-04-04	1/4	6.4	04	28	1/4-18	15
X0370-04-06	1/4	6.4	04	28	3/8-18	19
X0370-05-04	5/16	7.9	05	28	1/4-18	15
X0370-05-06	5/16	7.9	05	28	3/8-18	19
X0370-06-04	3/8	9.5	06	28	1/4-18	17
X0370-06-06	3/8	9.5	06	28	3/8-18	19
X0370-06-08	3/8	9.5	06	34	1/2-14	22
X0370-08-06	1/2	12.7	08	29	3/8-18	19
X0370-08-08	1/2	12.7	08	35	1/2-14	22
X0370-08-12	1/2	12.7	08	36	3/4-14	27
X0370-10-08	5/8	15.9	10	35	1/2-14	24
X0370-10-12	5/8	15.9	10	36	3/4-14	27
X0370-12-12	3/4	19	12	37	3/4-14	27
X0370-12-16	3/4	19	12	43	1-11.1/2	36
X0370-16-16	1	25.4	16	44	1-11.1/2	36
X0370-16-20	1	25.4	16	46	1.1/4-11.1/2	46
X0370-20-20	1.1/4	31.8	20	47	1.1/4-11.1/2	46
X0370-24-24	1.1/2	38.1	24	49	1.1/2-11.1/2	50
X0370-32-32	2	50.8	32	55	2-11.1/2	65

X0850

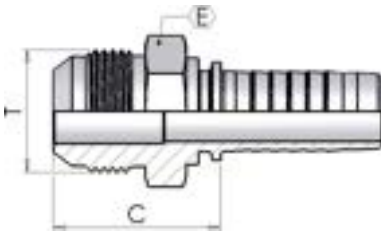

JIC Male 74° cone

(AGJ)

Product number	hose I.D.		I.D.	Dimension		
	in	mm		dash size	T	E
X0850-04-04	1/4	6.4	04	7/16-20	12	27
X0850-04-05	1/4	6.4	04	1/2-20	14	27
X0850-04-06	1/4	6.4	04	9/16-18	15	27
X0850-05-06	5/16	7.9	05	9/16-18	15	27
X0850-06-06	3/8	9.5	06	9/16-18	15	27
X0850-06-08	3/8	9.5	06	3/4-16	19	30
X0850-08-08	1/2	12.7	08	3/4-16	19	31
X0850-08-10	1/2	12.7	08	7/8-14	24	35
X0850-10-10	5/8	15.9	10	7/8-14	24	35
X0850-10-12	5/8	15.9	10	1.1/16-12	27	37
X0850-12-12	3/4	19	12	1.1/16-12	27	38
X0850-12-16	3/4	19	12	1.5/16-12	34	42
X0850-16-16	1	25.4	16	1.5/16-12	34	43
X0850-16-20	1	25.4	16	1.5/8-12	42	46
X0850-20-20	1.1/4	31.8	20	1.5/8-12	42	47
X0850-20-24	1.1/4	31.8	20	1.7/8-12	50	52
X0850-24-24	1.1/2	38.1	24	1.7/8-12	50	52
X0850-32-32	2	50.8	32	2.1/2-12	65	62

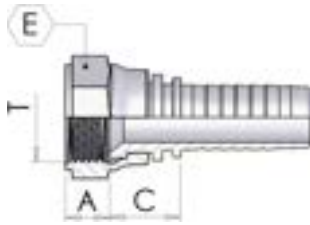
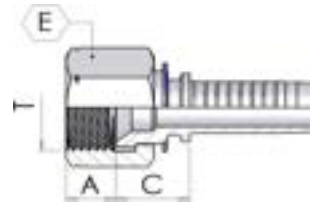
X0901**X0902****JIC Female 74°****(DKJ)**

Product number	hose I.D.		Dimension				
	in	mm	dash size	T	E	Cut-off C	A
X0901-03-04	3/16	4.8	03	7/16-20	15	14	8.5
X0901-04-04	1/4	6.4	04	7/16-20	15	14	8.5
X0902-04-05	1/4	6.4	04	1/2-20	17	17	9.5
X0902-04-06	1/4	12.7	04	9/16-18	19	17	9
X0902-05-06	5/16	7.9	05	9/16-18	19	16	9
X0901-06-06	3/8	9.5	06	9/16-18	19	16	9
X0902-06-08	3/8	9.5	06	3/4-16	22	18	10.5
X0901-08-08	1/2	12.7	08	3/4-16	24	18	10.5
X0902-08-10	1/2	12.7	08	7/8-14	27	20	13
X0901-10-10	5/8	15.9	10	7/8-14	27	19	13
X0902-10-12	5/8	15.9	10	1.1/16-12	32	20	13.5
X0901-12-12	3/4	19	12	1.1/16-12	32	22	13.5
X0901-12-16	3/4	19	12	1.5/16-12	38	23	15.5
X0901-16-12	1	25.4	16	1.1/16-12	32	23	13.5
X0901-16-16	1	25.4	16	1.5/16-12	38	24	15.5
X0901-20-20	1.1/4	31.8	20	1.5/8-12	50	28	16.5
X0901-24-24	1.1/2	38.1	24	1.7/8-12	55	31	19
X0901-32-32	2	50.8	32	2.1/2-12	70	31	20

X0951

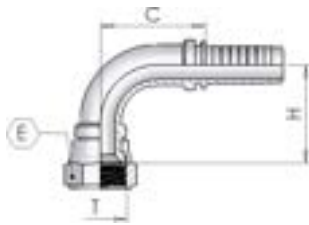

X0952

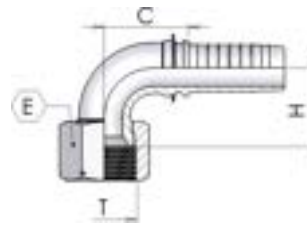

JIC 90° Swept Elbow 74° cone

(DKJ-90°)

Product number	hose I.D.		Dimension				
	in	mm	dash size	T	E	H	C
X0951-04-04	1/4	6.4	04	7/16-20	15	24	25
X0952-04-05	1/4	6.4	04	1/2-20	17	21	27
X0952-04-06	1/4	6.4	04	9/16-18	19	21	26
X0952-05-06	5/16	7.9	05	9/16-18	19	32	25
X0951-06-06	3/8	9.5	06	9/16-18	19	32	31
X0952-06-08	3/8	9.5	06	3/4-16	22	34	41
X0951-08-08	1/2	12.7	08	3/4-16	24	41	41
X0952-08-10	1/2	12.7	08	7/8-14	27	40	42
X0951-10-10	5/8	15.9	10	7/8-14	27	44	43
X0952-10-12	5/8	15.9	10	1.1/16-12	32	37	47
X0951-12-12	3/4	19	12	1.1/16-12	32	45	58
X0951-12-16	3/4	19	12	1.5/16-12	38	55	60
X0951-16-16	1	25.4	16	1.5/16-12	38	65	70
X0951-20-20	1.1/4	31.8	20	1.5/8-12	50	83	87
X0951-24-24	1.1/2	38.1	24	1.7/8-12	55	97	102
X0951-32-32	2	50.8	32	2.1/2-12	70	134	121

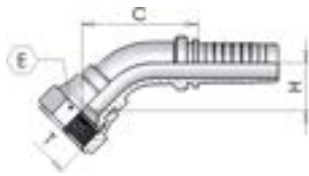
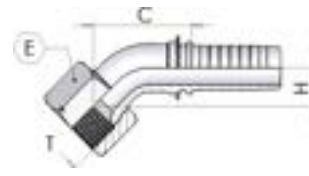
X1001**X1002****JIC 45° Swept Elbow 74°****(DKJ-45°)**

Product number	hose I.D.		Dimension				
	in	mm	dash size	T	E	H	C
X1001-04-04	1/4	6.4	04	7/16-20	15	13	38
X1002-04-05	1/4	6.4	04	1/2-20	17	15	38
X1002-04-06	1/4	6.4	04	9/16-18	19	16	38
X1002-05-06	5/16	7.9	05	9/16-18	19	18	47
X1001-06-06	3/8	9.5	06	9/16-18	19	17	51
X1002-06-08	3/8	9.5	06	3/4-16	22	19	52
X1001-08-08	1/2	12.7	08	3/4-16	24	22	62
X1002-08-10	1/2	12.7	08	7/8-14	27	23	64
X1001-10-10	5/8	15.9	10	7/8-14	27	24	68
X1001-12-12	3/4	19	12	1.1/16-12	32	21	81
X1001-12-16	3/4	19	12	1.5/16-12	38	28	88
X1001-16-16	1	25.4	16	1.5/16-12	38	29	83
X1001-20-20	1.1/4	31.8	20	1.5/8-12	50	42	108
X1001-24-24	1.1/2	38.1	24	1.7/8-12	55	49	156
X1001-32-32	2	50.8	32	2.1/2-12	70	65	142

X0500

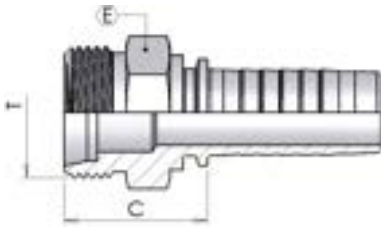

Metric Male 24° Seat Light

(CEL)

Product number	hose I.D.		Dimension				I.D.
	in	dash size	mm	T	erm.	E	Cut-off C
X0500-04-12	1/4	04	6.4	M12-1.5	6	14	23
X0500-04-14	1/4	04	6.4	M14-1.5	8	14	22
X0500-04-16	1/4	04	6.4	M16-1.5	10	17	23
X0500-05-16	5/16	05	7.9	M16-1.5	10	17	23
X0500-05-18	5/16	05	7.9	M18-1.5	12	19	24
X0500-06-16	3/8	06	9.5	M16-1.5	10	17	23
X0500-06-18	3/8	06	9.5	M18-1.5	12	19	24
X0500-06-22	3/8	06	9.5	M22-1.5	15	22	25
X0500-08-22	1/2	08	12.7	M22-1.5	15	22	26
X0500-08-26	1/2	08	12.7	M26-1.5	18	27	27
X0500-10-26	5/8	10	15.9	M26-1.5	18	27	27
X0500-10-30	5/8	10	15.9	M30-2	22	30	32
X0500-12-26	3/4	12	19	M26-1.5	18	27	28
X0500-12-30	3/4	12	19	M30-2	22	30	33
X0500-16-36	1	16	25.4	M36-2	28	36	32
X0500-20-45	1.1/4	20	31.8	M45-2	35	46	36
X0500-24-52	1.1/2	24	38.1	M52-2	42	55	38

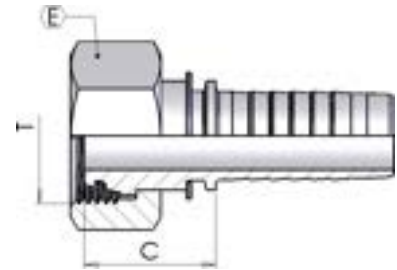
X0085**Metric Female 24° Seat Light****(DKOL)**

Product number	hose I.D.		Dimension				
	in	mm	dash size	T	erm.	E	Cut-off C
X0085-03-12	3/16	4.8	03	M12-1.5	6	14	23
X0085-04-12*	1/4	6.4	04	M12-1.5	6	14	25
X0085-04-14	1/4	6.4	04	M14-1.5	8	17	24
X0085-04-16	1/4	6.4	04	M16-1.5	10	19	24
X0085-04-18	1/4	6.4	04	M18-1.5	12	22	25
X0085-05-14*	5/16	7.9	05	M14-1.5	8	17	26
X0085-05-16	5/16	7.9	05	M16-1.5	10	19	24
X0085-05-18	5/16	7.9	05	M18-1.5	12	22	25
X0085-06-16*	3/8	9.5	06	M16-1.5	10	19	25
X0085-06-18	3/8	9.5	06	M18-1.5	12	22	25
X0085-06-22	3/8	9.5	06	M22-1.5	15	27	29
X0085-08-18*	1/2	12.7	08	M18-1.5	12	22	28
X0085-08-22	1/2	12.7	08	M22-1.5	15	27	29
X0085-08-26	1/2	12.7	08	M26-1.5	18	32	29
X0085-10-26	5/8	15.9	10	M26-1.5	18	32	29
X0085-10-30	5/8	15.9	10	M30-2	22	36	29
X0085-12-26*	3/4	19	12	M26-1.5	18	32	35
X0085-12-30	3/4	19	12	M30-2	22	36	29
X0085-12-36	3/4	19	12	M36-2	28	41	28
X0085-16-36	1	25.4	16	M36-2	28	41	30
X0085-20-45	1.1/4	31.8	20	M45-2	35	50	40
X0085-24-52	1.1/2	38.1	24	M52-2	42	60	41

*Rolled Nut

X0185

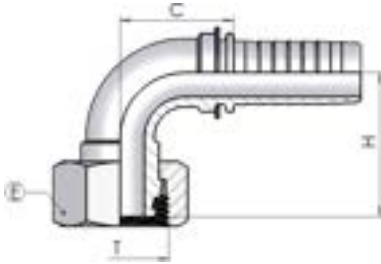

90° Metric Swept Elbow 24° Seat Light

(DKOL-90°)

Product number	hose I.D.		Dimension					I.D.
	in	dash size	mm	T	erm.	E	H	Cut-off C
X0185-03-12	3/16	03	4.8	M12-1.5	6	14	23	22
X0185-04-12*	1/4	04	6.4	M12-1.5	6	14	34	26
X0185-04-14	1/4	04	6.4	M14-1.5	8	17	26	26
X0185-04-16	1/4	04	6.4	M16-1.5	10	19	27	25
X0185-04-18	1/4	04	6.4	M18-1.5	12	22	30	27
X0185-05-16	5/16	05	7.9	M16-1.5	10	19	31	31
X0185-05-18	5/16	05	7.9	M18-1.5	12	22	32	31
X0185-06-16*	3/8	06	9.5	M16-1.5	10	19	39	32
X0185-06-18	3/8	06	9.5	M18-1.5	12	22	35	32
X0185-06-22	3/8	06	9.5	M22-1.5	15	27	35	32
X0185-08-22	1/2	08	12.7	M22-1.5	15	27	38	41
X0185-08-26	1/2	08	12.7	M26-1.5	18	32	39	41
X0185-10-26	5/8	10	15.9	M26-1.5	18	32	44	44
X0185-12-30	3/4	12	19	M30-2	22	36	52	58
X0185-12-36	3/4	12	19	M36-2	28	41	59	56
X0185-16-36	1	16	25.4	M36-2	28	41	65	69
X0185-20-45	1.1/4	20	31.8	M45-2	35	50	81	84
X0185-24-52	1.1/2	24	38.1	M52-2	42	60	93	102

*Rolled Nut

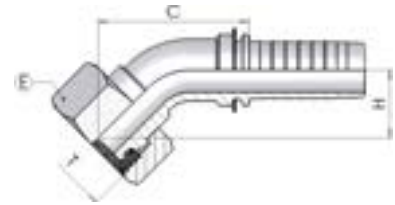
X0285**45° Metric Swept Elbow 24° Seat
Light****(DKOL-45°)**

Product number	hose I.D.	Dimension						I.D.
	in	dash size	mm	T	erm.	E	H	Cut-off C
X0285-03-12	3/16	03	4.8	M12-1.5	6	14	14	36
X0285-04-12*	1/4	04	6.4	M12-1.5	6	14	21	46
X0285-04-14	1/4	04	6.4	M14-1.5	8	17	14	42
X0285-04-16	1/4	04	6.4	M16-1.5	10	19	15	42
X0285-04-18	1/4	04	6.4	M18-1.5	12	22	16	43
X0285-05-16	5/16	05	7.9	M16-1.5	10	19	17	48
X0285-05-18	5/16	05	7.9	M18-1.5	12	22	18	48
X0285-06-16*	3/8	06	9.5	M16-1.5	10	19	22	55
X0285-06-18	3/8	06	9.5	M18-1.5	12	22	19	52
X0285-06-22	3/8	06	9.5	M22-1.5	15	27	19	51
X0285-08-22	1/2	08	12.7	M22-1.5	15	27	21	63
X0285-10-26	5/8	10	15.9	M26-1.5	18	32	23	68
X0285-12-30	3/4	12	19	M30-2	22	36	25	86
X0285-16-36	1	16	25.4	M36-2	28	41	29	81
X0285-20-45	1.1/4	20	31.8	M45-2	35	50	32	106
X0285-24-52	1.1/2	24	38.1	M52-2	42	60	43	119

*Rolled Nut

X0450

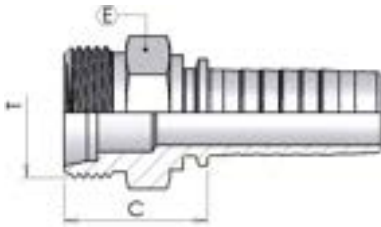

Metric Male 24° Seat Heavy

(CES)

Product number	hose I.D.		Dimension				
	in	mm	dash size	T	erm.	E	Cut-off C
X0450-04-14	1/4	6.4	04	M14-1.5	6	14	25
X0450-04-16	1/4	6.4	04	M16-1.5	8	17	27
X0450-04-18	1/4	6.4	04	M18-1.5	10	19	27
X0450-05-18	5/16	7.9	05	M18-1.5	10	19	27
X0450-05-20	5/16	7.9	05	M20-1.5	12	22	29
X0450-06-18	3/8	9.5	06	M18-1.5	10	19	27
X0450-06-20	3/8	9.5	06	M20-1.5	12	22	29
X0450-06-22	3/8	9.5	06	M22-1.5	14	22	31
X0450-06-24	3/8	9.5	06	M24-1.5	16	24	31
X0450-08-24	1/2	12.7	08	M24-1.5	16	24	32
X0450-10-30	5/8	15.9	10	M30-2	20	30	34
X0450-12-30	3/4	19	12	M30-2	20	30	35
X0450-12-36	3/4	19	12	M36-2	25	36	38
X0450-16-36	1	25.4	16	M36-2	25	36	39
X0450-16-42	1	25.4	16	M42-2	30	46	42
X0450-20-42	1.1/4	31.8	20	M42-2	30	46	43
X0450-20-52	1.1/4	31.8	20	M52-2	38	55	45
X0450-24-52	1.1/2	38.1	24	M52-2	38	55	45

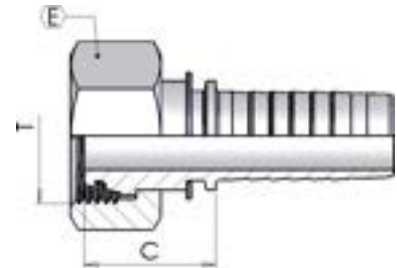
X0084**Metric Female 24° Seat Heavy****(DKOS)**

Product number	hose I.D.		Dimension				I.D.		Note
	in	dash size	mm	T	erm.	E	Cut-off C		
X0084-04-14	1/4	04	6.4	M14-1.5	6	17	23		
X0084-04-16	1/4	04	6.4	M16-1.5	8	19	25		
X0084-04-18	1/4	04	6.4	M18-1.5	10	22	24		
X0084-05-18	5/16	05	7.9	M18-1.5	10	22	25		
X0084-05-20	5/16	05	7.9	M20-1.5	12	24	25		
X0084-06-16	3/8	06	9.5	M16-1.5	8	22	26		
X0084-06-18	3/8	06	9.5	M18-1.5	10	22	25		
X0084-06-20	3/8	06	9.5	M20-1.5	12	24	25		
X0084-06-22	3/8	06	9.5	M22-1.5	14	27	29		
X0084-06-24	3/8	06	9.5	M24-1.5	16	30	29		
X0084-08-24	1/2	08	12.7	M24-1.5	16	30	30		
X0084-10-24*	5/8	10	15.9	M24-1.5	16	30	31	(*)	
X0084-10-30	5/8	10	15.9	M30-2	20	36	33		
X0084-12-30	3/4	12	19	M30-2	20	36	34		
X0084-12-36	3/4	12	19	M36-2	25	46	40		
X0084-16-36	1	16	25.4	M36-2	25	46	41		
X0084-16-42	1	16	25.4	M42-2	30	50	43		
X0084-20-52	1.1/4	20	31.8	M52-2	38	60	44		
X0084-24-52	1.1/2	24	38.1	M52-2	38	60	44		

*Rolled Nut

X0184

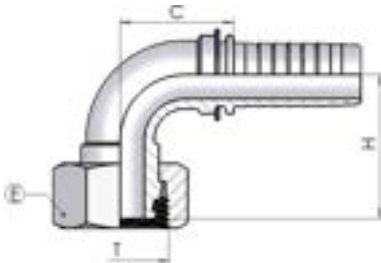

90° Metric Swept Elbow 24° Seat Heavy

(DKOS-90°)

Product number	hose I.D. / I.D.		Dimension					
	in	mm	dash size	T	erm.	E	H	Cut-off C
X0184-04-14	1/4	6.4	04	M14-1.5	6	17	26	27
X0184-04-16	1/4	6.4	04	M16-1.5	8	19	26	26
X0184-04-18	1/4	6.4	04	M18-1.5	10	22	31	27
X0184-05-18	5/16	7.9	05	M18-1.5	10	22	33	33
X0184-05-20	5/16	7.9	05	M20-1.5	12	24	34	30
X0184-06-18	3/8	9.5	06	M18-1.5	10	22	35	34
X0184-06-20	3/8	9.5	06	M20-1.5	12	24	34	34
X0184-06-22	3/8	9.5	06	M22-1.5	14	27	33	33
X0184-08-24	1/2	12.7	08	M24-1.5	16	30	41	40
X0184-10-30	5/8	15.9	10	M30-2	20	36	50	46
X0184-12-30	3/4	19	12	M30-2	20	36	56	58
X0184-12-36	3/4	19	12	M36-2	25	46	57	59
X0184-16-36	1	25.4	16	M36-2	25	46	67	77
X0184-16-42	1	25.4	16	M42-2	30	50	67	72
X0184-20-52	1.1/4	31.8	20	M52-2	38	60	82	84
X0184-24-52	1.1/2	38.1	24	M52-2	38	60	105	105

*Rolled Nut

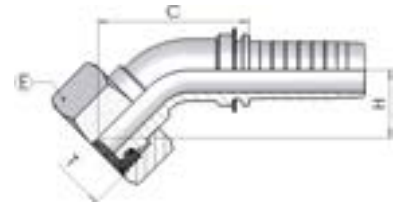
X0284**45° Metric Swept Elbow 24° Seat
Heavy****(DKOS-45°)**

Product number	hose I.D.		Dimension					
	in	mm	dash size	T	erm.	E	H	Cut-off C
X0284-04-14	1/4	6.4	04	M14-1.5	6	17	15	37
X0284-04-16	1/4	6.4	04	M16-1.5	8	19	15	42
X0284-04-18	1/4	6.4	04	M18-1.5	10	22	18	45
X0284-05-20	5/16	7.9	05	M20-1.5	12	24	19	49
X0284-06-18	3/8	9.5	06	M18-1.5	10	22	19	51
X0284-06-20	3/8	9.5	06	M20-1.5	12	24	18	53
X0284-06-22	3/8	9.5	06	M22-1.5	14	27	20	54
X0284-08-24	1/2	12.7	08	M24-1.5	16	30	21	63
X0284-10-30	5/8	15.9	10	M30-2	20	36	29	74
X0284-12-30	3/4	19	12	M30-2	20	36	30	87
X0284-12-36	3/4	19	12	M36-2	25	46	29	56
X0284-16-36	1	25.4	16	M36-2	25	46	30	85
X0284-16-42	1	25.4	16	M42-2	30	50	30	85
X0284-20-52	1.1/4	31.8	20	M52-2	38	60	39	105
X0284-24-52	1.1/2	38.1	24	M52-2	38	60	53	129

X0035

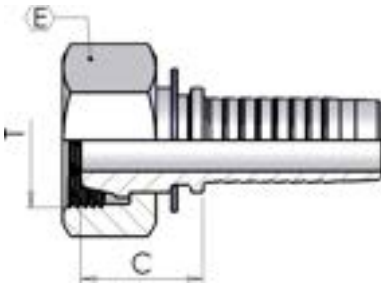

Metric Female 24° Seat Light Multiseal

(DKL)

Product number	hose I.D.		Dimension				
	in	mm	dash size	T	erm.	E	Cut-off C
X0035-04-14	1/4	6.4	04	M14-1.5	8	17	19
X0035-04-16	1/4	6.4	04	M16-1.5	10	19	19
X0035-05-16	5/16	7.9	05	M16-1.5	10	19	19
X0035-05-18	5/16	7.9	05	M18-1.5	12	22	21
X0035-06-18	3/8	9.5	06	M18-1.5	12	22	23
X0035-06-22	3/8	9.5	06	M22-1.5	15	27	22
X0035-08-22	1/2	12.7	08	M22-1.5	15	27	22
x0035-08-26	1/2	12.7	08	M26-1.5	18	32	24
X0035-10-26	5/8	15.9	10	M26-1.5	18	32	24

X0135

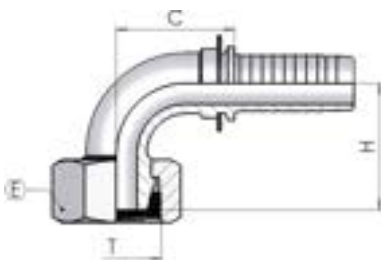

90° Metric Swept Elbow 24° Seat Light Multiseal

(DKL-90°)

Product number	hose I.D.		Dimension					I.D.
	in	dash size	mm	T	erm.	E	H	Cut-off C
X0135-04-14	1/4	04	6.4	M14-1.5	8	17	25	25
X0135-04-16	1/4	04	6.4	M16-1.5	10	19	24	26
X0135-05-16	5/16	05	7.9	M16-1.5	10	19	29	32
X0135-05-18	5/16	05	7.9	M18-1.5	12	22	30	31
X0135-06-18	3/8	06	9.5	M18-1.5	12	22	30	36
X0135-06-22	3/8	06	9.5	M22-1.5	15	27	33	32
X0135-08-22	1/2	08	12.7	M22-1.5	15	27	38	41
X0135-10-26	5/8	10	15.9	M26-1.5	18	32	42	46

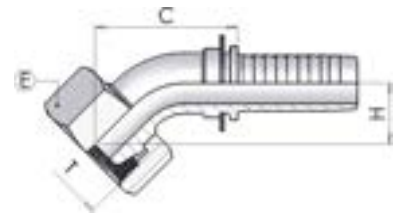
X0235**45° Metric Swept Elbow 24° Seat
Light Multiseal****(DKL-45°)**

Product number	hose I.D.		dash size	Dimension					Cut-off C
	in	mm		T	erm.	E	H		
X0235-04-14	1/4	6.4	04	M14-1.5	8	17	14	40	
X0235-04-16	1/4	6.4	04	M16-1.5	10	19	16	41	
X0235-05-16	5/16	7.9	05	M16-1.5	10	19	14	47	
X0235-05-18	5/16	7.9	05	M18-1.5	12	22	16	49	
X0235-06-18	3/8	9.5	06	M18-1.5	12	22	16	50	
X0235-08-22	1/2	12.7	08	M22-1.5	15	27	21	61	
X0235-10-26	5/8	15.9	10	M26-1.5	18	32	21	68	

X0550

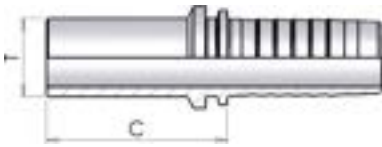

Metric Standpipe

(BEL-BES)

Product number	hose I.D.		Dimension			
	in	mm	dash size	Pipe T	Type	Cut-off C
X0550-04-06	1/4	6.4	04	6	L/S	32
X0550-04-08	1/4	6.4	04	8	L/S	30
X0550-04-10	1/4	6.4	04	10	L/S	33
X0550-04-12	1/4	6.4	04	12	L/S	30
X0550-05-08	5/16	7.9	05	08	L/S	31
X0550-05-10	5/16	7.9	05	10	L/S	31
X0550-05-12	5/16	7.9	05	12	L/S	33
X0550-06-10	3/8	9.5	06	10	L/S	33
X0550-06-12	3/8	9.5	06	12	L/S	32
X0550-06-14	3/8	9.5	06	14	S	37
X0550-06-15	3/8	9.5	06	15	L	32
X0550-08-12	1/2	12.7	08	12	L/S	36
X0550-08-15	1/2	12.7	08	15	L	34
X0550-08-16	1/2	12.7	08	16	S	39
X0550-08-18	1/2	12.7	08	18	L	35
X0550-10-18	5/8	15.9	10	18	L	35
X0550-10-20	5/8	15.9	10	20	S	45
X0550-12-20	3/4	19	12	20	S	46
X0550-12-22	3/4	19	12	22	L	38
X0550-12-25	3/4	19	12	25	S	49
X0550-16-25	1	25.4	16	25	S	51
X0550-16-28	1	25.4	16	28	L	41
X0550-16-30	1	25.4	16	30	S	54
X0550-20-35	1.1/4	31.8	20	35	L	48
X0550-20-38	1.1/4	31.8	20	38	S	62
X0550-24-42	1.1/2	38.1	24	42	L	50

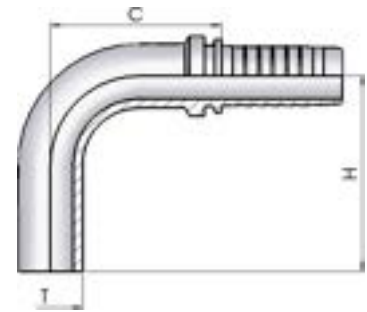
X0650**90° Metric Standpipe****(BEL-BES 90°)**

Product number	hose I.D.		Dimension				
	in	mm	dash size	Pipe T	Type	H	Cut-off C
X0650-04-06	1/4	6.4	04	6	L/S	32	23
X0650-04-08	1/4	6.4	04	8	L/S	34	25
X0650-04-10	1/4	6.4	04	10	L/S	43	25
X0650-05-10	5/16	7.9	05	10	L/S	40	29
X0650-05-12	5/16	7.9	05	12	L/S	45	29
X0650-06-10	3/8	9.5	06	10	L/S	40	27
X0650-06-12	3/8	9.5	06	12	L/S	44	30
X0650-06-14	3/8	9.5	06	12	S	58	30
X0650-08-12	1/2	12.7	08	12	L/S	44	33
X0650-08-15	1/2	12.7	08	15	L	52	39
X0650-08-16	1/2	12.7	08	16	L	57	41
X0650-10-18	5/8	15.9	10	18	L	56	51
X0650-10-20	5/8	15.9	10	20	S	65	51
X0650-10-22	5/8	15.9	10	22	L	65	51
X0650-12-22	3/4	19	12	22	L	71	51
X0650-12-25	3/4	19	12	25	S	75	57
X0650-16-28	1	25.4	16	28	L	89	60
X0650-16-30	1	25.4	16	30	S	89	65

X0750

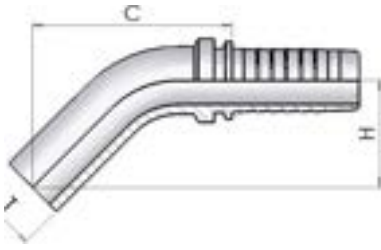

45° Metric Standpipe

(BEL-BES 45°)

Product number	hose I.D.		Dimension				
	in	mm	dash size	Pipe T	Type	H	Cut-off C
X0750-04-06	1/4	6.4	04	6	L/S	24	41
X0750-04-08	1/4	6.4	04	8	L/S	25	43
X0750-04-10	1/4	6.4	04	10	L/S	30	47
X0750-05-10	5/16	7.9	05	10	L/S	30	49
X0750-05-12	5/16	7.9	05	12	L/S	32	53
X0750-06-10	3/8	9.5	06	10	L/S	33	50
X0750-06-12	3/8	9.5	06	12	L/S	33	52
X0750-06-14	3/8	9.5	06	14	S	27	50
X0750-08-15	1/2	12.7	08	15	L	29	55
X0750-08-16	1/2	12.7	08	16	S	27	56
X0750-10-18	5/8	15.7	10	18	L	29	56
X0750-10-20	5/8	15.7	10	20	S	34	56
X0750-12-22	3/4	19	12	22	L	35	65
X0750-12-25	3/4	19	12	25	S	41	76
X0750-16-28	1	25.4	16	28	L	49	84
X0750-16-30	1	25.4	16	30	S	44	86

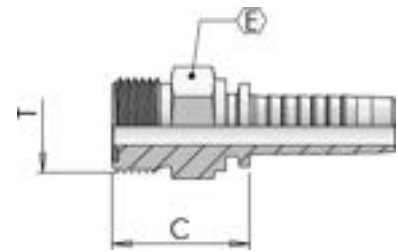
XS350**ORFS Male****(ORFS)**

Product number	hose I.D.		Dimension			
	in	mm	dash size	T	E	Cut-off C
XS350-04-06	1/4	6.4	04	9/16-18	17	23
XS350-05-09	5/16	7.9	05	11/16-16	19	26
XS350-06-09	3/8	9.5	06	11/16-16	19	26
XS350-08-11	1/2	12.7	08	13/16-16	22	29
XS350-10-13	5/8	15.9	10	1-14	27	33
XS350-12-14	3/4	19	12	1.3/16-12	32	36
XS350-16-15	1	25.4	16	1.7/16-12	38	37
XS350-20-21	1.1/4	31.8	20	1.11/16-12	46	39

- with plug and O-Ring

XS050

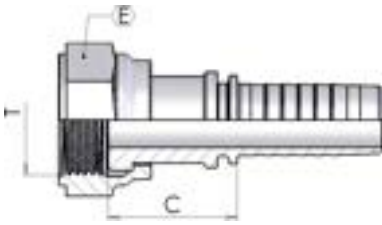

ORFS Female

(ORFS)

Product number	hose I.D.		Dimension				I.D.		Note
	in	dash size	mm	T	E	Cut-off C			
XS050-04-06	1/4	04	6.4	9/16-18	19	25			
XS050-04-09	1/4	04	6.4	11/16-16	22	29			
XS050-05-09	5/16	05	7.9	11/16-16	22	29			
XS050-06-09	3/8	06	9.5	11/16-16	22	29			
XS050-06-11	3/8	06	9.5	13/16-16	24	30			
XS050-08-11	1/2	08	12.7	13/16-16	24	32			
XS050-08-13	1/2	08	12.7	1-14	30	35			
XS050-08-14	1/2	08	12.7	1.3/16-12	36	37			
XS050-10-13	5/8	10	15.9	1-14	30	35			
XS050-10-14	5/8	10	15.9	1.3/16-12	36	34			
XS050-12-13	3/4	12	19	1-14	30	37			
XS050-12-14	3/4	12	19	1.3/16-12	36	35			
XS050-12-15	3/4	12	19	1.7/16-12	41	41			
XS050-16-15	1	16	25.4	1.7/16-12	41	39			
XS050-20-21	1.1/4	20	31.8	1.11/16-12	50	40	Slip on nut		
XS050-24-32	1.1/2	24	38.1	2-12	60	41	Slip on nut		

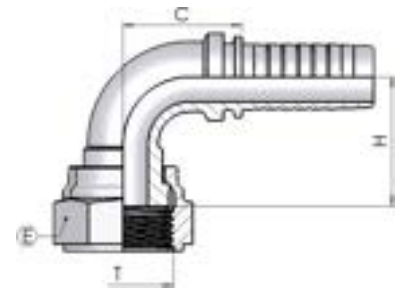
XS150**ORFS 90° Swept Elbow****(ORFS-90°)**

Product number	hose I.D.		Dimension				
	in	mm	dash size	T	E	H	Cut-off C
XS150-04-06	1/4	6.4	04	9/16-18	19	26	25
XS150-04-09	1/4	6.4	04	11/16-16	22	23	25
XS150-05-09	5/16	7.9	05	11/16-16	22	32	29
XS150-06-09	3/8	9.5	06	11/16-16	22	33	33
XS150-06-11	3/8	9.5	06	13/16-16	24	32	33
XS150-08-11	1/2	12.7	08	13/16-16	24	36	39
XS150-08-13	1/2	12.7	08	1-14	30	40	39
XS150-08-14	1/2	12.7	08	1.3/16-12	36	39	42
XS150-10-13	5/8	15.9	10	1-14	30	39	47
XS150-12-14	3/4	19	12	1.3/16-12	36	49	57
XS150-12-15	3/4	19	12	1.7/16-12	41	51	56
XS150-16-15	1	25.4	16	1.7/16-12	41	62	67
XS150-20-21	1.1/4	31.8	20	1.11/16-12	50	72	86
XS150-24-32	1.1/2	38.1	24	2-12	60	82	103

XS250

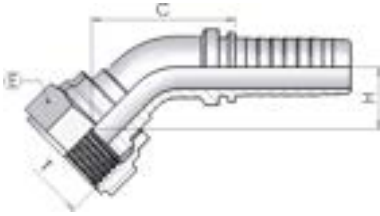

ORFS 45° Swept Elbow

(ORFS-45°)

Product number	hose I.D.		Dimension				I.D.
	in	dash size	mm	T	E	H	Cut-off C
XS250-04-06	1/4	04	6.4	9/16-18	19	14	40
XS250-04-09	1/4	04	6.4	11/16-16	22	14	38
XS250-05-09	5/16	05	7.9	11/16-16	22	14	44
XS250-06-09	3/8	06	9.5	11/16-16	22	17	52
XS250-06-11	3/8	06	9.5	13/16-16	24	18	51
XS250-08-11	1/2	08	12.7	13/16-16	24	20	62
XS250-08-13	1/2	08	12.7	1-14	30	23	64
XS250-08-14	1/2	08	12.7	1.3/16-12	36	23	62
XS250-10-13	5/8	10	15.9	1-14	30	22	67
XS250-12-14	3/4	12	19	1.3/16-12	36	23	84
XS250-12-15	3/4	12	19	1.7/16-12	41	26	84
XS250-16-15	1	16	25.4	1.7/16-12	41	31	100
XS250-20-21	1.1/4	20	31.8	1.11/16-12	50	44	111
XS250-24-32	1.1/2	24	38.1	2-12	60	53	123

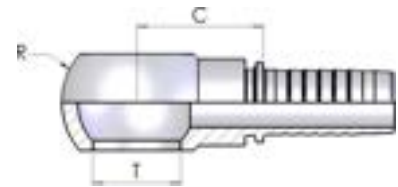
X1350**Metric Banjo****(RNM)**

Product number	hose I.D.		Dimension				
	in	mm	dash size	hole T	mm	R	Cut-off C
X1350-04-12	1/4	6.4	04	M12-1.5	12.2	20	22
X1350-04-14	1/4	6.4	04	M14-1.5	14.2	24	26
X1350-05-16	5/16	7.9	05	M16-1.5	16.2	28	26
X1350-06-16	3/8	9.5	06	M16-1.5	16.2	28	26
X1350-06-18	3/8	9.5	06	M18-1.5	18.2	32	29
X1350-08-18	1/2	12.7	08	M18-1.5	18.2	32	29
X1350-08-22	1/2	12.7	08	M22-1.5	22.2	36	31
X1350-12-26	3/4	19	12	M26-1.5	26.2	46	38

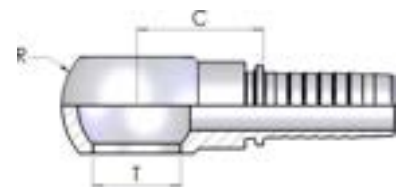
X1400**BSP Banjo****(RNR)**

Product number	hose I.D.		Dimension				
	in	mm	dash size	hole T	mm	R	Cut-off C
X1400-04-04	1/4	6.4	04	1/4-19	13.3	24	26
X1400-04-06	1/4	6.4	04	3/8-19	17	28	26
X1400-05-06	5/16	7.9	05	3/8-19	17	28	26
X1400-06-06	3/8	9.5	06	3/8-19	17	28	26
X1400-06-08	3/8	9.5	06	1/2-14	21.2	36	31
X1400-08-08	1/2	12.7	08	1/2-14	21.2	36	31
X1400-12-12	3/4	19	12	3/4-14	26.5	45	38
X1400-16-16	1	25.4	16	1-11	33.5	58	50

X1600

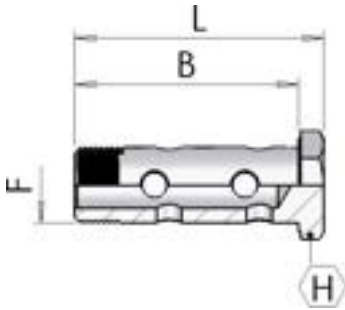

Double BSP Perforated Bolt

(BOLT)

Product number	Dimension			
	F	B	L	H
X1600-04-04	1/4-19	43	49	19
X1600-06-06	3/8-19	49	57	22
X1600-08-08	1/2-14	62	70	27
X1600-12-12	3/4-14	78	87	32
X1600-16-16	1-11	98	109	41

X1600-00

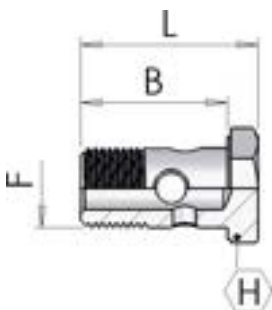

BSP Perforated Bolt

(BOLT)

Product number	Dimension				Box	Weight
	F	B	L	H	Q.ty	kg/unit
X1600-00-04	1/4"-19	29	34	19	500	0,033700
X1600-00-06	3/8"-19	33	41	22		0,056900
X1600-00-08	1/2"-14	38	46	27		0,089300
X1600-00-12	3/4"-14	47	56	32		0,175000
X1600-00-16	1"-11	58	69	41	5	0,344000

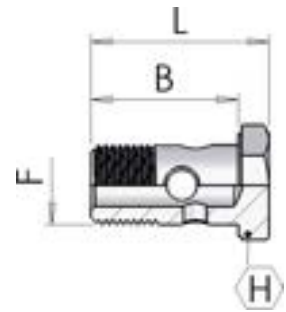
X1650**Metric perfored bolt****(BOLT)**

Product number	Dimension			
	F	B	L	H
X1650-00-12	M12-1.5	26	31	17
X1650-00-14	M14-1.5	29	34	19
X1650-00-16	M16-1.5	33	41	22
X1650-00-18	M18-1.5	37	44	24
X1650-00-22	M22-1.5	38	46	27
X1650-00-26	M26-1.5	47	56	32

X1260

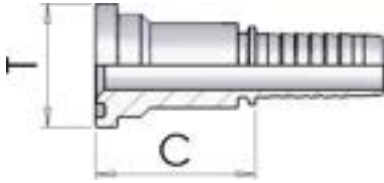

Straight SAE Flange 3000 PSI

(SFL)

Product number	hose I.D.		Dimension			
	in	mm	dash size	T Flange	mm	Cut-off C
X1260-08-08	1/2	12.7	08	1/2	30.2	45
X1260-08-12	1/2	12.7	08	3/4	38.1	50
X1260-10-12	5/8	15.9	10	3/4	38.1	49
X1260-12-12	3/4	19	12	3/4	38.1	50
X1260-12-16	3/4	19	12	1	44.5	53
X1260-16-16	1	25.4	16	1	44.5	54
X1260-16-20	1	25.4	16	1.1/4	50.8	57
X1260-20-20	1.1/4	31.8	20	1.1/4	50.8	59
X1260-20-24	1.1/4	31.8	20	1.1/2	60.3	62
X1260-24-24	1.1/2	38.1	24	1.1/2	60.3	62
X1260-24-32	1.1/2	38.1	24	2	71.4	67
X1260-32-32	2	50.8	32	2	71.4	68
X1260-32-40	2	50.8	32	2.1/2	84.1	76
X1260-40-40	2.1/2	63.5	40	2.1/2	84	76
X1260-48-48	3	76.2	48	3	102	63

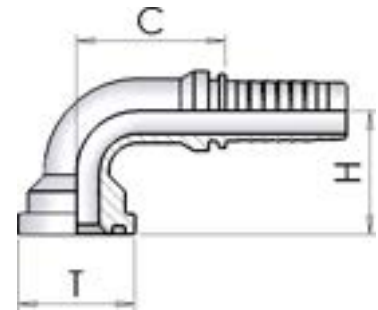
X1060**90° SAE Flange 3000 PSI****(SFL 90°)**

Product number	hose I.D.		Dimension				
	in	dash size	mm	T Flange	mm	drop H	Cut-off C
X1060-08-08	1/2	08	12.7	1/2	30.2	39	39
X1060-08-12	1/2	08	12.7	3/4	38.1	44	42
X1060-10-12	5/8	10	15.9	3/4	38.1	47	45
X1060-12-12	3/4	12	19	3/4	38.1	53	56
X1060-12-16	3/4	12	19	1	44.5	55	56
X1060-16-16	1	16	25.4	1	44.5	65	70
X1060-16-20	1	16	25.4	1.1/4	50.8	70	67
X1060-20-20	1.1/4	20	31.8	1.1/4	50.8	79	85
X1060-20-24	1.1/4	20	31.8	1.1/2	60.3	81	85
X1060-24-24	1.1/2	24	38.1	1.1/2	60.3	89	98
X1060-24-32	1.1/2	24	38.1	2	71.4	90	102
X1060-32-32	2	32	50.8	2	71.4	113	134

X1160

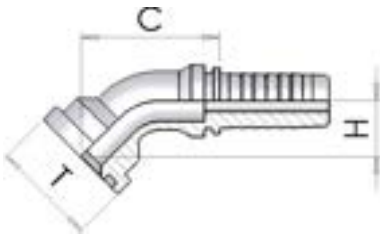

45° SAE Flange 3000 PSI

(SFL 45°)

Product number	hose I.D.		Dimension				
	in	mm	dash size	T Flange	mm	H	Cut-off C
X1160-08-08	1/2	12.7	08	1/2	30.2	22	62
X1160-08-12	1/2	12.7	08	3/4	38.1	25	67
X1160-12-12	3/4	19	12	3/4	38.1	25	69
X1160-12-16	3/4	19	12	1	44.5	30	88
X1160-16-16	1	25.4	16	1	44.5	29	82
X1160-16-20	1	25.4	16	1.1/4	50.8	35	75
X1160-20-20	1.1/4	31.8	20	1.1/4	50.8	38	102
X1160-20-24	1.1/4	31.8	20	1.1/2	60.3	39	106
X1160-24-24	1.1/2	38.1	24	1.1/2	60.3	44	114
X1160-24-32	1.1/2	38.1	24	2	71.4	40	115
X1160-32-32	2	50.8	32	2	71.4	58	135

XS003

Cut Split Flanges - 3000 psi

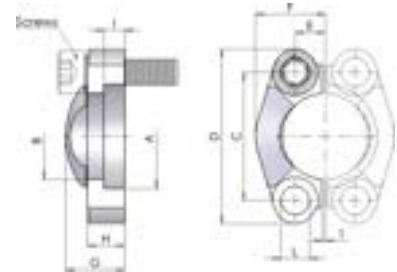

Product number	SAE	Dimension									
	size	A	B	C	D	E	F	G	H	I	L
XS003-08	1/2"	30.96	24.3	38.1	54	8.7	22.8	19	13	6.2	8.8
XS003-12	3/4"	38.89	32.1	47.6	65	11.1	25.9	22	14	6.2	10.8
XS003-16	1"	45.24	38.5	52.4	70	13.1	29.2	24	16	7.5	10.8
XS003-20	1 1/4"	51.59	43.7	58.7	79	15.1	36.3	22	14	7.5	12
XS003-24	1 1/2"	61.09	50.8	69.9	94	17.9	41.1	25	16	7.5	13.5
XS003-32	2"	72.24	62.7	77.8	102	21.4	48.2	26	16	9	13.5
XS003-40	2 1/2"	84.94	74.9	88.9	114	25.4	54.1	38	19	9	13.5
XS003-48	3"	102.4	90.9	106.4	135	30.9	65.3	41	22	9	16.8

XSI03

Uncut Split Flanges - 3000 psi

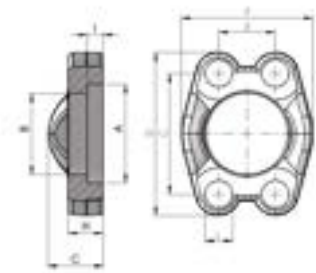

Product number	SAE	Dimension									
	size	A	B	C	D	E	F	G	H	I	L
XSI03-08	1/2"	30.96	24.3	38.1	54	17.5	45.6	19	13	6.2	8.8
XSI03-12	3/4"	38.89	32.1	47.6	65	22.2	51.8	22	14	6.2	10.8
XSI03-16	1"	45.24	38.5	52.4	70	26.2	58.4	24	16	7.5	10.8
XSI03-20	1 1/4"	51.59	43.7	58.7	79	30.2	72.6	22	14	7.5	12
XSI03-24	1 1/2"	61.09	50.8	69.9	94	35.7	82.2	25	16	7.5	13.5
XSI03-32	2"	72.24	62.7	77.8	102	42.9	96.4	26	16	9	13.5
XSI03-40	2 1/2"	84.94	74.9	88.9	114	50.8	108.2	38	19	9	13.5
XSI03-48	3"	102.4	90.9	106.4	135	61.9	130.6	41	22	9	16.8

X1310

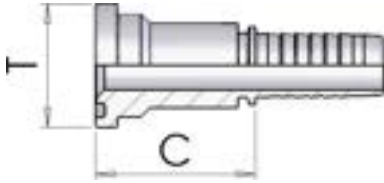

Straight SAE Flange 6000 PSI

(SFS)

Product number	hose I.D.		Dimension			
	in	dash size	mm	T Flange	mm	Cut-off C
X1310-08-08	1/2	08	12.7	1/2	31.8	46
X1310-08-12	1/2	08	12.7	3/4	41.3	53
X1310-10-12	5/8	10	15.9	3/4	41.3	53
X1310-12-12	3/4	12	19	3/4	41.3	54
X1310-12-16	3/4	12	19	1	47.6	60
X1310-16-16	1	16	25.4	1	47.6	61
X1310-16-20	1	16	25.4	1.1/4	54	68
X1310-20-20	1.1/4	20	31.8	1.1/4	54	70
X1310-20-24	1.1/4	20	31.8	1.1/2	63.5	76
X1310-24-24	1.1/2	24	38.1	1.1/2	63.5	76
X1310-24-32	1.1/2	24	38.1	2	79.4	85
X1310-32-32	2	32	50.8	2	79.4	85

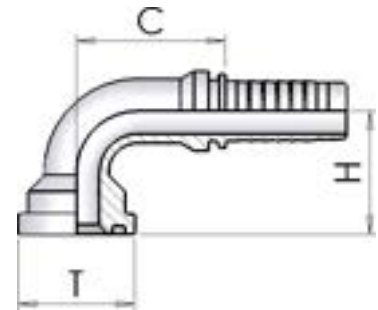
X1110**90° SAE Flange 6000 PSI****(SFS 90°)**

Product number	hose I.D.		Dimension				
	in	dash size	mm	T Flange	mm	drop H	Cut-off C
X1110-08-08	1/2	08	12.7	1/2	31.8	39	39
X1110-08-12	1/2	08	12.7	3/4	41.3	48	39
X1110-10-12	5/8	10	15.9	3/4	41.3	52	44
X1110-12-12	3/4	12	19	3/4	41.3	55	56
X1110-12-16	3/4	12	19	1	47.6	63	56
X1110-16-12	1	16	25.4	3/4	41.3	64	68
X1110-16-16	1	16	25.4	1	47.6	69	70
X1110-16-20	1	16	25.4	1.1/4	54	74	71
X1110-20-20	1.1/4	20	31.8	1.1/4	54	83	97
X1110-20-24	1.1/4	20	31.8	1.1/2	63.5	93	97
X1110-24-24	1.1/2	24	38.1	1.1/2	63.5	103	100
X1110-24-32	1.1/2	24	38.1	2	79.4	108	100
X1110-32-32	2	32	50.8	2	79.4	136	125

X1210

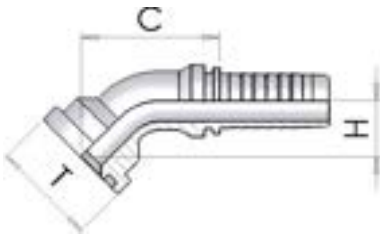

45° SAE Flange 6000 PSI

(SFS 45°)

Product number	hose I.D.		Dimension				
	in	mm	dash size	T Flange	mm	drop H	Cut-off C
X1210-08-08	1/2	12.7	08	1/2	31.8	22	62
X1210-08-12	1/2	12.7	08	3/4	41.3	28	69
X1210-10-12	5/8	15.9	10	3/4	41.3	27	75
X1210-12-12	3/4	19	12	3/4	41.3	28	74
X1210-12-16	3/4	19	12	1	47.6	32	90
X1210-16-16	1	25.4	16	1	47.6	34	86
X1210-16-20	1	25.4	16	1.1/4	54	37	90
X1210-20-20	1.1/4	31.8	20	1.1/4	54	41	111
X1210-20-24	1.1/4	31.8	20	1.1/2	63.5	48	118
X1210-24-24	1.1/2	38.1	24	1.1/2	63.5	50	122
X1210-32-32	2	50.8	32	2	79.4	58	151

XS006

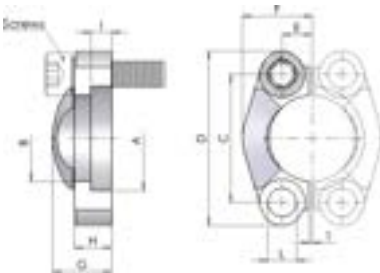

Cut Split Flanges - 6000 psi

Product number	SAE size	Dimension									
		A	B	C	D	E	F	G	H	I	L
XS006-08	1/2"	32.54	24.6	40.5	56	9.1	23.6	22	16	7.2	8.8
XS006-12	3/4"	42.06	32.5	50.8	71	11.9	30	28	19	8.3	11
XS006-16	1"	48.41	38.9	57.2	81	13.9	34.8	33	24	9	13
XS006-20	1.1/4"	54.76	44.5	66.7	95	15.9	38.6	38	27	9.8	15
XS006-24	1.1/2"	64.29	51.6	79.4	113	18.3	47.5	43	30	12.1	17
XS006-32	2"	80.16	67.6	96.8	133	22.2	56.9	52	37	12.1	21

XSI06

Uncut Split Flanges - 6000 psi

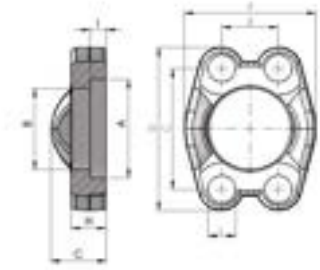

Product number	SAE	Dimension									
	size	A	B	C	D	E	F	G	H	I	L
XSI06-08	1/2"	32.54	24.6	40.5	56	18.2	47.2	22	16	7.2	8.8
XSI06-12	3/4"	42.06	32.5	50.8	71	23.8	60	28	19	8.3	11
XSI06-16	1"	48.41	38.9	57.2	81	27.8	69.6	33	24	9	13
XSI06-20	1"1/4	54.76	44.5	66.7	95	31.8	77.2	38	27	9.8	15
XS006-24	1"1/2	64.29	51.6	79.4	113	36.5	95	43	30	12.1	17
XS006-32	2"	80.16	67.6	96.8	133	44.5	113.8	52	37	12.1	21

XFK50

K' Female

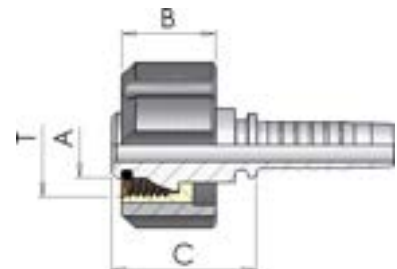

Product number	hose I.D.	Dimension					I.D.
	in	dash size	mm	T	A	B	Cut-off C
XFK50-04-22	1/4	04	6.4	M22-1.5	14	20	31
XFK50-05-22	5/16	05	7.9	M22-1.5	14	20	31
XFK50-06-22	3/8	06	9.5	M22-1.5	14	20	31

XD050



Hose Junction

Product number	hose I.D.		I.D.		Dimension	
	in	mm	dash size	Cut-off C		
XD050-04	1/4	6.4	04	22		
XD050-06	3/8	9.5	06	22		
XD050-08	1/2	12.7	08	23		
XD050-10	5/8	15.9	10	18		
XD050-12	3/4	19	12	19		
XD050-16	1	25.4	16	21		

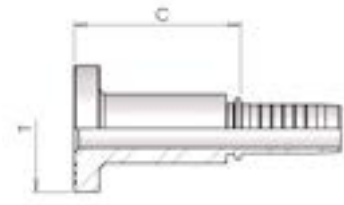
XRPF**Swivel Flange End Fitting PN6/10/16**

Product number	hose I.D.		Dimension		
	in	mm	dash size	T	C
XRPF-06-10-06	3/8	9.5	06	35	64
XRPF-08-15-06	1/2	12.7	08	42	65
XRPF-10-15-06	5/8	15.9	10	42	66
XRPF-12-20-06	3/4	19	12	52	66
XRPF-16-25-06	1	25.4	16	62	65
XRPF-20-32-06	1.1/4	31.8	20	72	61
XRPF-24-40-06	1.1/2	38.1	24	82	61
XRPF-32-50-06	2	50.8	32	92	56
XRPF-40-65-06	2.1/2	63.5	40	112	57
XRPF-48-80-06	3	76.2	48	128	63
XRPF-06-10-16	3/8	9.5	06	40	68
XRPF-08-15-16	1/2	12.7	08	44	67
XRPF-10-15-16	5/8	15.9	10	44	68
XRPF-12-20-16	3/4	19	12	58	70
XRPF-16-25-16	1	25.4	16	68	69
XRPF-20-32-16	1.1/4	31.8	20	78	65
XRPF-24-40-16	1.1/2	38.1	24	88	65
XRPF-32-50-16	2	50.8	32	100	60
XRPF-40-65-16	2.1/2	63.5	40	122	61
XRPF-48-80-16	3	76.2	48	138	67

XFLG

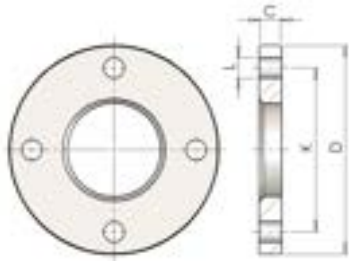

EN Flanges Sliding planes

EN 1092-1/02 type A PN 6-PN 16-PN 40

Product number	DN	PN	Dimension				Bolt	
	mm	bar	C	D	K	L	N	Size
XFLG-06-10-06	10	6	12	75	50	11	4	M10
XFLG-08-15-06	15	6	12	80	55	11	4	M10
XFLG-12-20-06	20	6	14	90	65	11	4	M10
XFLG-16-25-06	25	6	14	100	75	11	4	M10
XFLG-20-32-06	32	6	16	120	90	14	4	M12
XFLG-24-40-06	40	6	16	130	100	14	4	M12
XFLG-32-50-06	50	6	16	140	110	14	4	M12
XFLG-40-65-06	65	6	16	160	130	14	4	M12
XFLG-48-80-06	80	6	18	190	150	18	4	M16
XFLG-64-100-06	100	6	18	210	170	18	4	M16
XFLG-32-50-16	50	16	19	165	125	18	4	M16
XFLG-40-65-16	65	16	20	185	145	18	8	M16
XFLG-48-80-16	80	16	20	200	160	18	8	M16
XFLG-64-100-16	100	16	22	220	180	18	8	M16
XFLG-06-10-40	10	40	14	90	60	14	4	M12
XFLG-08-15-40	15	40	14	95	65	14	4	M12
XFLG-12-20-40	20	40	16	105	75	14	4	M12
XFLG-16-25-40	25	40	16	115	85	14	4	M12
XFLG-20-32-40	32	40	18	140	100	18	4	M16
XFLG-24-40-40	40	40	18	150	110	18	4	M16

Interlock Stainless Steel Fittings





X004N



Swaged Ferrule (skive)

61

X0013



Swaged Ferrule (skive)

61



X0350H



BSP Male Parallel 60° cone

62

X0051H



BSP Female 60° Cone - Rolled Nut

62

X0151H



BSP 90° Swept Elbow 60° Cone - Rolled Nut

63

X0251H



BSP 45° Swept Elbow 60° Cone Rolled nut

63



X0370H



NPTF Male 60° cone

64



X0450H



Metric Male 24° Seat Heavy

64

X0084H



Metric Female 24° Seat Heavy

65

X0184H



90° Metric Swept Elbow 24° Seat Heavy

65

X0284H



45° Metric Swept Elbow 24° Seat Heavy

66



X0850H



JIC Male 74° cone

66

X0901H



JIC Female 74° cone -
Rolled Nut

67

X0951H



JIC 90° Swept Elbow 74°
cone Rolled Nut

67

X1001H



JIC 45° Swept Elbow 74°
Cone Rolled Nut

68



XS350H



ORFS Male

68

XS05TH



ORFS Female Back
Hexagon

69

XS150H



ORFS 90° Swept Elbow

69

XS250H



ORFS 45° Swept Elbow

70



X1250H



Straight SAE Flange
3000 PSI

70

X1050H



90° SAE Flange 3000 PSI

71

X1150H



45° SAE Flange 3000 PSI

71



X1300H



Straight SAE Flange
6000 PSI

72

X1100H



90° SAE Flange 6000 PSI

72

X1200H



45° SAE Flange 6000 PSI

73

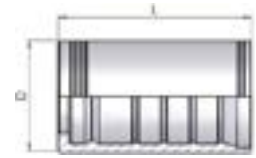
X004N**Swaged Ferrule (skive)**

Product number	hose I.D.		Dimension		skive	valid for
	in	mm	D	L	Length	
X004N-12	3/4	19	38	60	52/15	R13-4SH-R15 -(4SP)
X004N-16	1	25.4	46	75	64/17	4SH-R13-R15-(4SP)
X004N-20	1.1/4	31.8	55	88	74/22	4SH
X004N-24	1.1/2	38.1	62	94	81/22,5	4SH
X004N-32	2	50.8	78	99	85/30	4SH

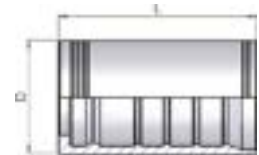
X0013**Swaged Ferrule (skive)**

Product number	hose I.D.		Dimension		skive	valid for
	in	D	mm	L	Length	
X0013-20	1.1/4	60	31.8	88	74/22	R13 -R15
X0013-24	1.1/2	67	38.1	94	81/22,5	R13 -R15
X0013-32	2	85	50.8	99	85/30	R13-R15

X0350H

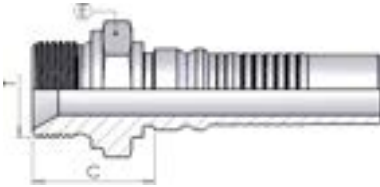

BSP Male Parallel 60° cone

(AGR)

Product number	hose I.D.		Dimension			
	in	mm	dash size	Thread T	hex E	Cut-off C
X0350H12-12	3/4	19	12	3/4-14	32	33
X0350H16-16	1	25.4	16	1-11	41	37
X0350H20-20	1.1/4	31.8	20	1.1/4-11	50	42
X0350H24-24	1.1/2	38.1	24	1.1/2-11	55	44
X0350H32-32	2	50.8	32	2-11	70	53

X0051H



BSP Female 60° Cone - Rolled Nut

(DKR)

Product number	hose I.D.		Dimension				Note
	in	mm	dash size	T	E	Cut-off C	
X0051H12-12	3/4	19	12	3/4-14	32	23	(*)
X0051H16-16	1	25.4	16	1-11	38	26	(*)
X0051H20-20	1.1/4	31.8	20	1.1/4-11	50	29	(*)
X0051H24-24	1.1/2	38.1	24	1.1/2-11	55	31	(*)
X0051H32-32	2	50.8	32	2-11	70	30	(*)

(*) - BSP O-Ring Female

X0151H

BSP 90° Swept Elbow 60° Cone - Rolled Nut

(DKR 90°)

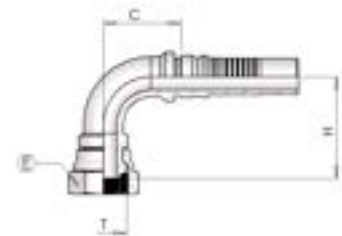

Product number	hose I.D.		Dimension					Note
	in	mm	dash size	T	E	H	Cut-off C	
X0151H12-12	3/4	19	12	3/4-14	32	57	54	(*)
X0151H16-16	1	25.4	16	1-11	38	70	73	(*)
X0151H20-20	1.1/4	31.8	20	1.1/4-11	50	83	93	(*)
X0151H24-24	1.1/2	38.1	24	1.1/2-11	55	104	111	(*)
X0151H32-32	2	50.8	32	2-11	70	135	122	(*)

(*) - BSP O-Ring Female



X0251H

BSP 45° Swept Elbow 60° Cone Rolled nut

(DKR 45°)

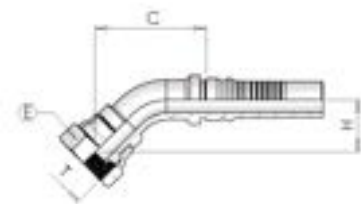

Product number	hose I.D.		Dimension					Note
	in	dash size	mm	Thread T	hex E	drop H	Cut-off C	
X0251H12-12	3/4	12	19	3/4-14	32	31	85	(*)
X0251H16-16	1	16	25.4	1-11	41	38	112	(*)
X0251H20-20	1.1/4	20	31.8	1.1/4-11	50	41	98	(*)
X0251H24-24	1.1/2	24	38.1	1.1/2-11	55	54	166	(*)
X0251H32-32	2	32	50.8	2-11	70	71	143	(*)

(*) - BSP O-Ring Female



X0370H

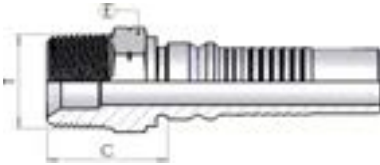

NPTF Male 60° cone

(AGN)

Product number	hose I.D.		Dimension			
	in	mm	dash size	Thread T	hex E	Cut-off C
X0370H12-12	3/4	19	12	3/4-14	27	35
X0370H16-16	1	25.4	16	1-11.1/2	36	41
X0370H20-20	1.1/4	31.8	20	1.1/4-11.1/2	46	44
X0370H24-24	1.1/2	38.1	24	1.1/2-11.1/2	50	47
X0370H32-32	2	50.8	32	2-11.1/2	65	54

X0450H

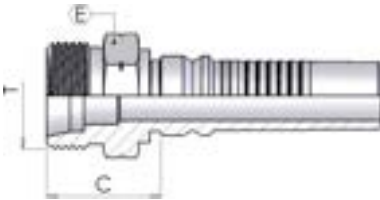

Metric Male 24° Seat Heavy

(CES)

Product number	hose I.D.		Dimension				
	in	mm	dash size	Thread T	erm.	hex E	Cut-off C
X0450H12-30	3/4	19	12	M30-2	20	30	32
X0450H12-36	3/4	19	12	M36-2	25	36	36
X0450H16-36	1	25.4	16	M36-2	25	36	36
X0450H16-42	1	25.4	16	M42-2	30	46	39
X0450H20-52	1.1/4	31.8	20	M52-2	38	55	42
X0450H24-52	1.1/2	38.1	24	M52-2	38	55	42.5

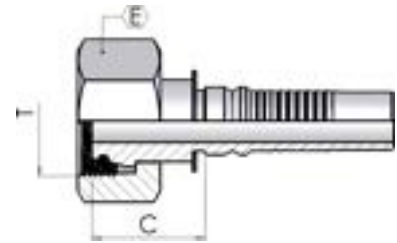
X0084H**Metric Female 24° Seat Heavy****(DKOS)**

Product number	hose I.D.		Dimension				
	in	dash size	mm	Thread T	erm.	hex E	Cut-off C
X0084H12-30	3/4	12	19	M30-2	20	36	32
X0084H12-36	3/4	12	19	M36-2	25	46	37
X0084H16-36	1	16	25.4	M36-2	25	46	38
X0084H16-42	1	16	25.4	M42-2	30	50	41
X0084H20-52	1.1/4	20	31.8	M52-2	38	60	41
X0084H24-52	1.1/2	24	38.1	M52-2	38	60	42

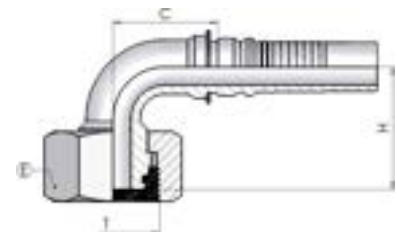
X0184H**90° Metric Swept Elbow 24° Seat Heavy****(DKOS 90°)**

Product number	hose I.D.		Dimension					
	in	mm	dash size	Thread T	erm.	hex E	drop H	Cut-off C
X0184H12-30	3/4	19	12	M30-2	20	36	58	55
X0184H12-36	3/4	19	12	M36-2	25	46	58	55
X0184H16-36	1	25.4	16	M36-2	25	46	68	75
X0184H16-42	1	25.4	16	M42-2	30	50	69	74
X0184H20-52	1.1/4	31.8	20	M52-2	38	60	83	94

X0284H

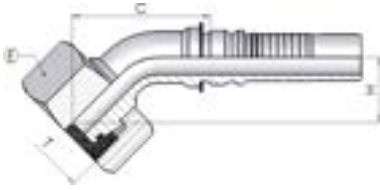

45° Metric Swept Elbow 24° Seat Heavy

(DKOS 45°)

Product number	hose I.D.		Dimension					
	in	mm	dash size	Thread T	erm.	hex E	drop H	Cut-off C
X0284H12-30	3/4	19	12	M30-2	20	36	30	64
X0284H12-36	3/4	19	12	M36-2	25	46	31	86
X0284H16-36	1	25.4	16	M36-2	25	46	34	82
X0284H16-42	1	25.4	16	M42-2	30	50	33	112
X0284H20-52	1.1/4	31.8	20	M52-2	38	60	40	105

X0850H

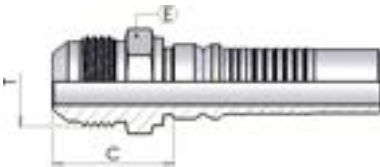

JIC Male 74° cone

(AGJ)

Product number	hose I.D.		Dimension			
	in	mm	dash size	Thread T	hex E	Cut-off C
X0850H12-12	3/4	19	12	1.1/16-12	27	36
X0850H16-16	1	25.4	16	1.5/16-12	34	40
X0850H20-20	1.1/4	31.8	20	1.5/8-12	42	44
X0850H24-24	1.1/2	38.1	24	1.7/8-12	50	49
X0850H32-32	2	50.8	32	2.1/2-12	65	61

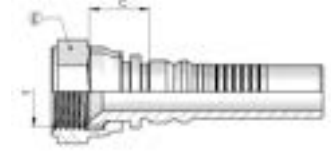
X0901H**JIC Female 74° cone - Rolled Nut****(DKJ)**

Product number	hose I.D.		Dimension			
	in	dash size	mm	Thread T	hex E	Cut-off C
X0901H12-12	3/4	12	19	1.1/16-12	32	19
X0901H16-16	1	16	25.4	1.5/16-12	41	23
X0901H20-20	1.1/4	20	31.8	1.5/8-12	50	26
X0901H24-24	1.1/2	24	38.1	1.7/8-12	55	29
X0901H32-32	2	32	50.8	2.1/2-12	70	30

X0951H**JIC 90° Swept Elbow 74° cone Rolled Nut****(DKJ 90°)**

Product number	hose I.D.		Dimension				
	in	dash size	mm	Thread T	hex E	drop H	Cut-off C
X0951H12-12	3/4	12	19	1.1/16-12	32	57	55
X0951H16-16	1	16	25.4	1.5/16-12	41	68	74
X0951H20-20	1.1/4	20	31.8	1.5/8-12	50	86	92
X0951H24-24	1.1/2	24	38.1	1.7/8-12	55	100	112
X0951H32-32	2	32	50.8	2.1/2-12	70	134	121

X1001H

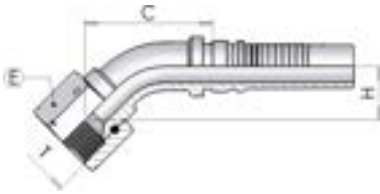

JIC 45° Swept Elbow 74° Cone Rolled Nut

(DKJ 45°)

Product number	hose I.D.		Dimension				
	in	mm	dash size	Thread T	hex E	drop H	Cut-off C
X1001H12-12	3/4	19	12	1.1/16-12	32	28	85
X1001H16-16	1	25.4	16	1.5/16-12	41	33	83
X1001H20-20	1.1/4	31.8	20	1.5/8-12	50	40	109
X1001H24-24	1.1/2	38.1	24	1.7/8-12	55	49	165
X1001H32-32	2	50.8	32	2.1/2-12	70	67	190

XS350H

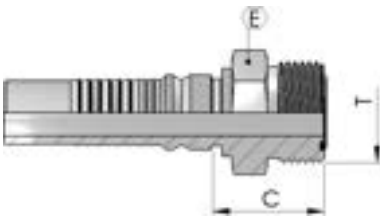

ORFS Male

(AGO)

Product number	hose I.D.		Dimension			
	in	mm	dash size	T	E	Cut-off C
XS350H12-14	3/4	19	12	1.3/16-12	32	34
XS350H16-15	1	25.4	16	1.7/16-12	38	35
XS350H20-21	1.1/4	31.8	20	1.11/16-12	46	36
XS350H24-32	1.1/2	38.1	24	2-12	55	39

with plug and o'ring

XS05TH

ORFS Female Back Hexagon

(ORFS)

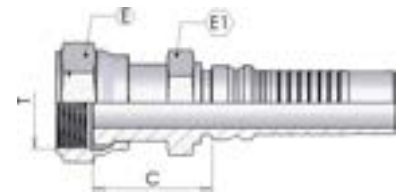

Product number	hose I.D.		Dimension				
	in	mm	dash size	T	E	E1	Cut-off C
XS05TH12-14	3/4	19	12	1.3/16-12	36	30	39
XS05TH16-15	1	25.4	16	1.7/16-12	41	36	47
XS05TH20-21	1.1/4	31.8	20	1.11/16-12	46	46	50
XS05TH24-32	1.1/2	38.1	24	2-12	50	50	53

XS150H

ORFS 90° Swept Elbow

(ORFS 90°)

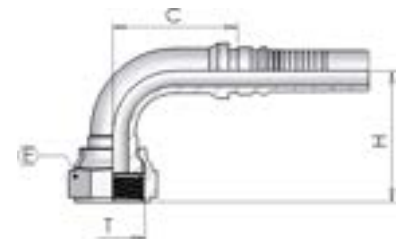

Product number	hose I.D.		Dimension				
	in	mm	dash size	T	E	H	Cut-off C
XS150H12-14	3/4	19	12	1.3/16-12	36	49	54
XS150H16-15	1	25.4	16	1.7/16-12	41	66	69
XS150H20-21	1.1/4	31.8	20	1.11/16-12	50	80	87
XS150H24-32	1.1/2	38.1	24	2-12	60	102	111

XS250H

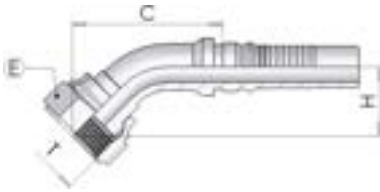

ORFS 45° Swept Elbow

(ORFS 45°)

Product number	hose I.D.		Dimension					Note
	in	mm	dash size	T	E	H	Cut-off C	
XS250H12-14	3/4	19	12	1.3/16-12	36	23	84	
XS250H16-15	1	25.4	16	1.7/16-12	41	33	107	
XS250H20-21	1.1/4	31.8	20	1.11/16-12	50	37	130	Dado Libero
XS250H24-32	1.1/2	38.1	24	2-12	60	50	165	

X1250H

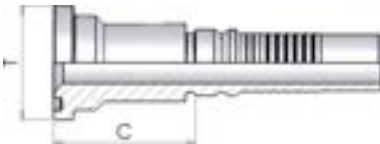

Straight SAE Flange 3000 PSI

(SFL)

Product number	hose I.D.		Dimension			
	in	mm	dash size	T Flange	mm	Cut-off C
X1250H12-12	3/4	19	12	3/4	38.1	47
X1250H12-16	3/4	19	12	1	44.5	50
X1250H16-16	1	25.4	16	1	44.5	52
X1250H16-20	1	25.4	16	1.1/4	50.8	55
X1250H20-20	1.1/4	31.8	20	1.1/4	50.8	56
X1250H20-24	1.1/4	31.8	20	1.1/2	60.3	59
X1250H24-24	1.1/2	38.1	24	1.1/2	60.3	60
X1250H32-32	2	50.8	32	2	71.4	67

X1050H

90° SAE Flange 3000 PSI

(SFL 90°)

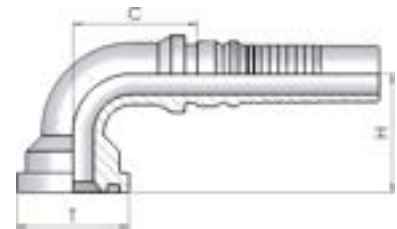

Product number	hose I.D.		Dimension				
	in	mm	dash size	T Flange	mm	drop H	Cut-off C
X1050H12-12	3/4	19	12	3/4	38.1	52	52
X1050H12-16	3/4	19	12	1	44.5	56	55
X1050H16-16	1	25.4	16	1	44.5	65	73
X1050H16-20	1	25.4	16	1.1/4	50.8	71	69
X1050H20-20	1.1/4	31.8	20	1.1/4	50.8	82	91
X1050H20-24	1.1/4	31.8	20	1.1/2	60.3	80	97
X1050H24-24	1.1/2	38.1	24	1.1/2	60.3	94	109
X1050H32-32	2	50.8	32	2	71.4	113	128

X1150H

45° SAE Flange 3000 PSI

(SFL 45°)

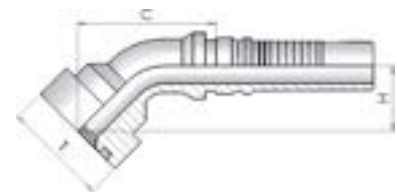

Product number	hose I.D.		Dimension				
	in	dash size	mm	T Flange	mm	drop H	Cut-off C
X1150H12-12	3/4	12	19	3/4	38.1	25	81
X1150H12-16	3/4	12	19	1	44.5	28	86
X1150H16-16	1	16	25.4	1	44.5	35	107
X1150H16-20	1	16	25.4	1.1/4	50.8	37	113
X1150H20-20	1.1/4	20	31.8	1.1/4	50.8	37	136
X1150H20-24	1.1/4	20	31.8	1.1/2	60.3	40	136
X1150H24-24	1.1/2	24	38.1	1.1/2	60.3	44	159
X1150H32-32	2	32	50.8	2	71.4	56	182

X1300H

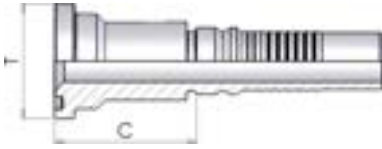

Straight SAE Flange 6000 PSI

(SFS)

Product number	hose I.D.		Dimension				I.D.
	in	mm	dash size	T Flange	mm	Cut-off C	
X1300H12-12	3/4	19	12	3/4	41.3	51	
X1300H12-16	3/4	19	12	1	47.6	57	
X1300H16-16	1	25.4	16	1	47.6	59	
X1300H16-20	1	25.4	20	1.1/4	54	66	
X1300H20-20	1.1/4	31.8	20	1.1/4	54	67	
X1300H20-24	1.1/4	31.8	20	1.1/2	63.5	73	
X1300H24-20	1.1/2	38.1	24	1.1/4	54	75	
X1300H24-24	1.1/2	38.1	24	1.1/2	63.5	74	
X1300H32-32	2	50.8	32	2	79.4	84	

X1100H

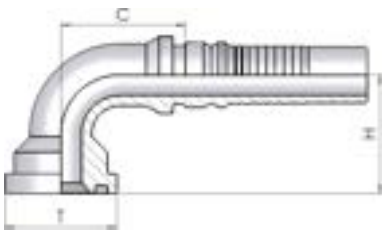

90° SAE Flange 6000 PSI

(SFS 90°)

Product number	hose I.D.		Dimension				
	in	mm	dash size	T Flange	mm	drop H	Cut-off C
X1100H12-12	3/4	19	12	3/4	41.3	55	53
X1100H12-16	3/4	19	12	1	47.6	63	52
X1100H16-16	1	25.4	16	1	47.6	69	75
X1100H16-20	1	25.4	16	1.1/4	54	74	71
X1100H20-20	1.1/4	31.8	20	1.1/4	54	84,5	93
X1100H20-24	1.1/4	31.8	20	1.1/2	63.5	92	94
X1100H24-24	1.1/2	38.1	24	1.1/2	63.5	101	114
X1100H32-32	2	50.8	32	2	79.4	126	136.5

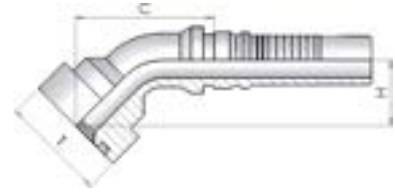
X1200H**45° SAE Flange 6000 PSI****(SFS 45°)**

Product number	hose I.D.		Dimension				
	in	mm	dash size	T Flange	mm	drop H	Cut-off C
X1200H12-12	3/4	19	12	3/4	41.3	28	85
X1200H12-16	3/4	19	12	1	47.6	34	88
X1200H16-16	1	25.4	16	1	47.6	34	84
X1200H16-20	1	25.4	16	1.1/4	54	40	117
X1200H20-20	1.1/4	31.8	20	1.1/4	54	41	109
X1200H20-24	1.1/4	31.8	20	1.1/2	63.5	46	113
X1200H24-24	1.1/2	38.1	24	1.1/2	63.5	50	133
X1200H32-32	2	50.8	32	2	79.4	58	204

Analytic Index

X001C	8	XD050	54
X0022	9	XRPF	55
X0009	10	XFLG	56
X0007	10	X004N	61
X0008	11	X0013	61
X0003	11	X0350H	62
XPTFE	12	X0051H	62
XPTFE-C	12	X0151H	63
X0345	13	X0251H	63
X0061	14	X0370H	64
X0062	14	X0450H	64
X0161	15	X0084H	65
X0162	15	X0184H	65
X0350	16	X0284H	66
X0051	17	X0850H	66
X0052	17	X0901H	67
X0151	18	X0951H	67
X0152	18	X1001H	68
X0251	19	XS350H	68
X0252	19	XS05TH	69
X0360	20	XS150H	69
X0370	21	XS250H	70
X0850	22	X1250H	70
X0901	23	X1050H	71
X0902	23	X1150H	71
X0951	24	X1300H	72
X0952	24	X1100H	72
X1001	25	X1200H	73
X1002	25		
X0500	26		
X0085	27		
X0185	28		
X0285	29		
X0450	30		
X0084	31		
X0184	32		
X0284	33		
X0035	34		
X0135	34		
X0235	35		
X0550	36		
X0650	37		
X0750	38		
XS350	39		
XS050	40		
XS150	41		
XS250	42		
X1350	43		
X1400	43		
X1600	44		
X1600-00	44		
X1650	45		
X1260	46		
X1060	47		
X1160	48		
XS003	49		
XSI03	49		
X1310	50		
X1110	51		
X1210	52		
XS006	52		
XSI06	53		
XFK50	53		

Sections Index

Standard Stainless Steel Fittings	1	K' Female	53
Swaged Ferrule (no skive)	8	Hose Junction	54
Swaged Ferrule (no skive)	9	Swivel Flange End Fitting PN6/10/16	55
Swaged Ferrule (skive)	10	EN Flanges Sliding planes	56
Swaged Ferrule (no skive)	10	Interlock Stainless Steel Fittings	57
Swaged Ferrule (no skive)	11	Swaged Ferrule (skive)	61
Swaged Ferrule (no skive)	11	Swaged Ferrule (skive)	61
Ferrule for PTFE hose	12	BSP Male Parallel 60° cone	62
Ferrule for PTFE hose	12	BSP Female 60° Cone - Rolled Nut	62
BSP Male - Flat Seat	13	BSP 90° Swept Elbow 60° Cone - Rolled Nut	63
BSP Female flat seat	14	BSP 45° Swept Elbow 60° Cone Rolled nut	63
BSP Female Flat Seat Slip on Nut	14	NPTF Male 60° cone	64
Curva BSP 90° Sede Piana	15	Metric Male 24° Seat Heavy	64
BSP 90° Swept elbow flat seat - Slip On Nut	15	Metric Female 24° Seat Heavy	65
BSP Male Parallel 60° cone	16	90° Metric Swept Elbow 24° Seat Heavy	65
BSP Female 60° Cone	17	45° Metric Swept Elbow 24° Seat Heavy	66
BSP Female 60° Cone Slip On Nut	17	JIC Male 74° cone	66
BSP 90° Swept elbow 60° cone	18	JIC Female 74° cone - Rolled Nut	67
BSP 90° Swept elbow 60° cone Slip On Nut	18	JIC 90° Swept Elbow 74° cone Rolled Nut	67
BSP 45° Swept Elbow 60° Cone	19	JIC 45° Swept Elbow 74° Cone Rolled Nut	68
BSP 45° Swept Elbow 60° Cone Slip On Nut	19	ORFS Male	68
BSP Taper Male 60° cone	20	ORFS Female Back Hexagon	69
NPTF Male 60° cone	21	ORFS 90° Swept Elbow	69
JIC Male 74° cone	22	ORFS 45° Swept Elbow	70
JIC Female 74°	23	Straight SAE Flange 3000 PSI	70
JIC Female 74° - Slip on nut	23	90° SAE Flange 3000 PSI	71
JIC 90° Swept Elbow 74° cone	24	45° SAE Flange 3000 PSI	71
JIC 90° Swept Elbow 74° cone - Slip on nut	24	Straight SAE Flange 6000 PSI	72
JIC 45° Swept Elbow 74°	25	90° SAE Flange 6000 PSI	72
JIC 45° Swept Elbow 74° Cone Slip On Nut	25	45° SAE Flange 6000 PSI	73
Metric Male 24° Seat Light	26		
Metric Female 24° Seat Light	27		
90° Metric Swept Elbow 24° Seat Light	28		
45° Metric Swept Elbow 24° Seat Light	29		
Metric Male 24° Seat Heavy	30		
Metric Female 24° Seat Heavy	31		
90° Metric Swept Elbow 24° Seat Heavy	32		
45° Metric Swept Elbow 24° Seat Heavy	33		
Metric Female 24° Seat Light Multiseal	34		
90° Metric Swept Elbow 24° Seat Light Multiseal	34		
45° Metric Swept Elbow 24° Seat Light Multiseal	35		
Metric Standpipe	36		
90° Metric Standpipe	37		
45° Metric Standpipe	38		
ORFS Male	39		
ORFS Female	40		
ORFS 90° Swept Elbow	41		
ORFS 45° Swept Elbow	42		
Metric Banjo	43		
BSP Banjo	43		
Double BSP Perforated Bolt	44		
BSP Perforated Bolt	44		
Metric perforated bolt	45		
Straight SAE Flange 3000 PSI	46		
90° SAE Flange 3000 PSI	47		
45° SAE Flange 3000 PSI	48		
Cut Split Flanges - 3000 psi	49		
Uncut Split Flanges - 3000 psi	49		
Straight SAE Flange 6000 PSI	50		
90° SAE Flange 6000 PSI	51		
45° SAE Flange 6000 PSI	52		
Cut Split Flanges - 6000 psi	52		
Uncut Split Flanges - 6000 psi	53		



INTERPUMP

FLUID SOLUTIONS 

Powered by I.M.M. Hydraulics



I.M.M. Hydraulics Spa
interpumpfluidsolutions.com

Via Italia, 49-51
66041 - Atessa (Ch) - Italy
T. +39 (0) 0872 889225
F. +39 (0) 0872 889226

