

Inserto Standard





001C



Boccola a Pressare (non skive)

11

002Z



Boccola a Pressare (non skive)

12

012N



Boccola a Pressare

13

0001



Boccola a Pressare (skive)

14

0002



Boccola a Pressare (skive)

15



0009



Boccola a Pressare (skive)

16

004H



Boccola a Pressare (skive)

16

OSI4



Boccola a Pressare (skive)

17

BMC1



Boccola a Pressare (non skive)

17

BMC2



Boccola a Pressare (non skive)

18



0007



Boccola a Pressare (non skive)

18

0008



Boccola a Pressare (non skive)

19

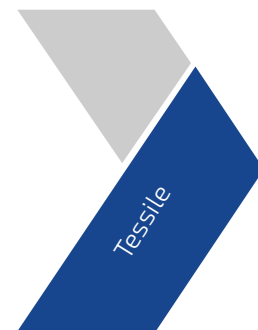

0003



Boccola a Pressare (non skive)

19



PTFE



Boccola per tubo PTFE

20

PTFE-C



Boccola per tubo PTFE

20



0345



Maschio BSP Sede Piana

21

0060



Femmina BSP Sede Piana

22



0350



Maschio BSP svas. 60°

23

035G



Maschio BSP Svas.60° - girevole

24

0050



Femmina BSP cono 60° Dado Spinato

25

0051



Femmina BSP cono 60° Dado Rollato

25

0058



Femmina BSP cono 60° Dado Libero

25

0051D



Femmina BSP cono 60° Doppio esagono

26

0150



Curva BSP cono 60° Dado Spinato

27

0151



Curva BSP 90° cono 60° Dado Rollato

27

0158



Curva BSP 90° cono 60°
Dado Libero

27

0250



Curva BSP cono 60° Dado
Spinato

28

0251



Curva BSP 45° cono 60°
Dado rullato

28

0258



Curva BSP 45° cono 60°
Dado libero

28

2321



Compatta BSP 90° cono
60° - Dado rullato

29

2300



Compatta BSP 90° cono
60° - Dado spinato -
Welded

29

0041



Femmina BSP cono 60°
con O-Ring Dado Rullato

30

0048



Femmina BSP cono 60°
con O-Ring Dado Libero

30

0141



Curva BSP 90° cono
60° con O-Ring Dado
Rullato

31

0148



Curva BSP 90° cono
60° con O-Ring - Dado
Libero

31

0241



Curva 45° BSP cono 60°
con O-Ring Dado Rullato

32

0248



Curva BSP 45° cono 60°
con O-Ring - Dado libero

32



0360



Maschio BSPT svas. 60°

33



0370



Maschio NPTF svas. 60°

34

037G



Maschio NPTF Svas.60°
Girevole

35

N051



Femmina NPSM cono 60°
dado rullato

35



0850



Maschio JIC cono 74°

36

0900



Femmina JIC svas. 74°
Dado Spinato

37

0901



Femmina JIC svas. 74°
Dado Rullato

37

0902



Femmina JIC svas. 74°-
Dado libero

37

0901D



Femmina JIC svas. 74°-
Doppio esagono

38

0950



Curva JIC 90° svas.74°
Dado Spinato

39

0951



Curva JIC 90° svas.74° -
Dado rullato

39

0952



Curva JIC 90° svas.74° -
Dado libero

39

1000



Curva JIC 45° svas.74°
Dado Spinato

40

1001



Curva JIC 45° svas.74°
Dado Rullato

40

1002



Curva JIC 45° svas.74°
Dado libero

40

095S



Curva JIC 90° svas.74° -
ISO SHORT

41

2971



Compatta JIC 90° svas.
74° - Dado Crimpato

41



0385



Maschio SAE O'R Sede Piana

42



0500



Maschio Metrico svas. 24° Serie Leggera

43

0085



Femmina Metrica cono 24° Serie Leggera

44

0185



Curva Metrica 90° cono 24° Serie Leggera

45

0285



Curva Metrica 45° cono 24° Serie Leggera

46



0450



Maschio Metrico svas. 24° Serie Pesante

47

0084



Femmina Metrica cono 24° Serie Pesante

48

0184



Curva Metrica 90° cono 24° Serie Pesante

49

0284



Curva Metrica 45° cono 24° Serie Pesante

50



0550



Femmina Metrica Tubolare Diritta

51

0650



Femmina Metrica Tubolare 90°

52

0650S



Femmina Metrica Tubolare 90° (saldata)

52

0750



Femmina Metrica Tubolare 45°

53

0750S



Femmina Metrica Tubolare 45° (saldata)

53



0035



Femmina Metrica Cono 24° Serie Leggera Multiseal

54

0135



Curva Metrica 90° Cono 24° Serie Leggera Multiseal

55



0400



Maschio Metrico Svas. 60°

56

0100



Femmina Metrica Cono 60°

57

0200



Curva Metrica 90° cono 60°

58



S350



Maschio ORFS

59

S050



Femmina ORFS

60

S05T



Femmina ORFS doppio esagono

61

S150



Curva ORFS 90°

62

S15S



Curva ORFS 90° - ISO SHORT

63

S250



Curva ORFS 45°

64



1260



Flangia Diritta SAE 3000 PSI

65

1060



Flangia 90° SAE 3000 PSI

66

1160



Flangia 45° SAE 3000 PSI

67

FS3L



Flangia 90° SAE 3000 PSI
- Tipo Lungo

67

S003



Semiflange tagliate -
3000 psi

68



1310



Flangia Diritta SAE 6000
PSI

69

1110



Flangia 90° SAE 6000 PSI

70

1210



Flangia 45° SAE 6000 PSI

71

FS6L



Flangia 90° SAE 6000 PSI
- Tipo Lungo

71

S006

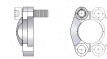

Semiflange tagliate -
6000 psi

72



130S



Flangia Diritta SUPERCAT

72

110S



Flangia 90° SUPERCAT

73

120S



Flangia 45° SUPERCAT

73



1250



Flangia Komatsu dritta

74

1050



Flangia Komatsu 90°

74

1150



Flangia Komatsu 45°

74

0940



Femmina JIS Cono 60°
(Komatsu)

75

0990S



Curva 90° JIS Cono 60°
(Komatsu) - saldata

76



0930



Femmina JIS cono 60°
(Toyota)

76

0980S



Curva JIS 90° (Toyota) -
saldata

77



0920



Femmina JIS cono 60°
(Nissan)

77



0030



Femmina Metrica Cono
24° Serie Francese

78



FK50



Femmina Tipo 'K' per
Idropulitrici

78

FN50



Inserti Tipo 'K' (per
Lancia) - Diametro 10

79

FN51



Inserti Tipo 'K' (per lancia) - Diametro 11

79

Banjo/bolt

1400



Occhio a Pressare BSP

80

1600



Bullone forato Gas Doppio

81

1600-00



Bullone forato Gas

81

1350



Occhio a Pressare Metrico

82

1650



Bullone forato Metrico

83

Junction

D050



Giunzione per Tubi Flessibili

84

Weldable Fitting

GS00



Gambo a Saldare

85

001C

Boccola a Pressare (non skive)

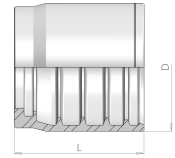

Product number	hose I.D.		I.D.		Dimension		skive	valid for
	in	mm	D	L	Length	-		
001C-03	3/16	4,8	18,5	24	NO	R17-25C-15N-Pilot-H1		
001C-04	1/4	6,4	20	26	NO	R17-25C-15C-15N-Pilot-H1		
001C-05	5/16	7,9	22	28	NO	R17-25C-15C-15N-Pilot-H1		
001C-06	3/8	9,5	25	28	NO	R17-25C-15C-15N-Pilot-H1		
001C-08	1/2	12,7	28	28	NO	R17-25C-15C-15N-Pilot-H1		
001C-10	5/8	15,9	32	31	NO	R17-25C-15C-15N-H1		
001C-12	3/4	19	36	38	NO	R17-25C-15C-15N-H1		
001C-16	1	25,4	44	47,5	NO	R17-25C-15C-15N-H1		
001C-20	1.1/4	31,8	54	56	NO	15N-25C-15C		
001C-24	1.1/2	38,1	61,6	66	NO	15N-25C-15C		
001C-32	2	50,8	75,4	73	NO	15N-25C-15C		
001C-40	2.1/2	63,5	88,4	80	NO	25C-15C		
001C-48	3	76,2	100,5	90	NO	25C-15C		

0022

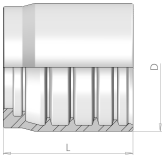

Boccola a Pressare (non skive)

Product number	hose I.D.	I.D.	Dimension		skive	valid for
	in	mm	D	L	Length	-
0022-03	3/16	4.8	21	25.3	NO	25N-(15N)
0022-04	1/4	6.4	22	28	NO	25N-(15N)
0022-05	5/16	7.9	24	28	NO	25N-(15N)
0022-06	3/8	9.5	26	28	NO	25N-(15N)
0022-08	1/2	12.7	30	31	NO	25N-(15N)
0022-10	5/8	15.9	34	31	NO	25N-(15N)
0022-12	3/4	19	38	38.5	NO	25N-(15N)
0022-16	1	25.4	47	48	NO	25N-(15N)
0022-20	1.1/4	31.8	58	56	NO	25N-(15N)
0022-24	1.1/2	38.1	66	66	NO	25N-(15N)
0022-32	2	50.8	79	73	NO	25N-(15N)

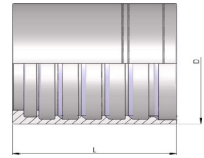
012N**Boccola a Pressare**

Product number	hose I.D.	I.D.	Dimension		skive	valid for
	in	mm	D	L	Length	
012N-04	1/4	6.4	18.3	28	21	ONE 1RN-TWO 2RN-2MC-2SC
012N-05	5/16	7.9	20.0	29	22	ONE 1RN-TWO 2RN-2MC-2SC
012N-06	3/8	9.5	22.8	30	23	ONE 1RN-TWO 2RN-2MC-2SC
012N-08	1/2	12.7	26.3	32	24	ONE 1RN-TWO 2RN-2MC-2SC
012N-10	5/8	15.9	29.8	34	26	ONE 1RN-TWO 2RN-2MC-2SC
012N-12	3/4	19	34.4	40	31	ONE 1RN-TWO 2RN-2MC-2SC
012N-16	1	25.4	42.9	49	38	ONE 1RN-TWO 2RN-2MC-2SC
012N-20	1.1/4	31.8	52.5	56	43	TWO 2RN
012N-24	1.1/2	38.1	59.2	63	49	TWO 2RN
012N-32	2	50.8	72.2	73	58	TWO 2RN

None

0001

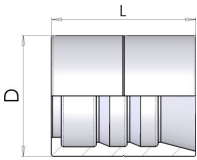

Boccola a Pressare (skive)

Product number	hose I.D.		I.D.		Dimension		skive Length	valid for
	in	mm	D	L				
0001-03	3/16	4.8	17.5	27	20	15N-(25C-15T)		
0001-04	1/4	6.4	20	30.2	23	15N-(25C-15T)		
0001-05	5/16	7.9	22	30.7	23	15N-(25C-15T)		
0001-06	3/8	9.5	24	32	24	15N-(25C-15T)		
0001-08	1/2	12.7	28.5	34	25	15N-(25C-15T)		
0001-10	5/8	15.9	32	37	27	15N-(25C-15T)		
0001-12	3/4	19	36	43	31	15N-(25C-15T)		
0001-16	1	25.4	43	50	37	15N-(25C-15T)		
0001-20	1.1/4	31.8	52	57	46	15N-(25C-15T)		
0001-24	1.1/2	38.1	57	63	44	15N-(25C-15T)		
0001-32	2	50.8	70.6	78	60	15N-(25C-15T)		

0002

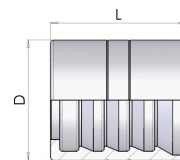
Boccola a Pressare (skive)

Product number	hose I.D.		I.D.		Dimension		skive	valid for
	in	mm	D	L	Length	-		
0002-03	3/16	4.8	20	27	21	25N-(2ST)		
0002-04	1/4	6.4	21	30	22	25N-(2ST)		
0002-05	5/16	7.9	24	30	22	25N-(2ST)		
0002-06	3/8	9.5	25.4	32	24	25N-3SC-(2ST)		
0002-08	1/2	12.7	30	34	25	25N-(2ST)		
0002-10	5/8	15.9	34	37	27	25N-(2ST)		
0002-12	3/4	19	38	43	31	25N-(2ST)		
0002-16	1	25.4	46	50	37	25N-(2ST)		
0002-20	1.1/4	31.8	56	59	43	25N-(2ST)		
0002-24	1.1/2	38.1	62	63	45	25N-(2ST)		
0002-32	2	50.8	75	79	61	25N-(2ST)		
0002-40	2.1/2	63.5	95	83.7	63	25N-(2ST)		
0002-48	3	76.2	105.6	94.3	78	25N-(2ST)		

0009

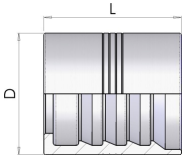

Boccola a Pressare (skive)

Product number	hose I.D.	Dimension		I.D.	skive	valid for
	in	D	mm	L	Length	
0009-04	1/4	21	6.4	30	22	4SP-R12
0009-06	3/8	25.4	9.5	33.5	26	4SP-R12
0009-08	1/2	30	12.7	36	28	4SP-R12
0009-10	5/8	34	15.9	40	31	4SP-R12
0009-12	3/4	38	19	43	34	4SP-(R12-4SH)
0009-16	1	46	25.4	60	48	(4SP-R12)
0009-20	1.1/4	56	31.8	66	54	(4SP-R12)
0009-24	1.1/2	67	38.1	76.5	62	(4SP-R12)
0009-32	2	80	50.8	79.8	64	4SP

004H

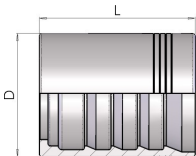

Boccola a Pressare (skive)

Product number	hose I.D.	I.D.	Dimension		skive	valid for
	in	mm	D	L	Length	
004H-20	1.1/4	31.8	52	66	55	(4SH)
004H-24	1.1/2	38.1	62	76.5	63	(4SH)
004H-32	2	50.8	75	79.8	65	R12

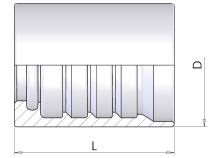
OSI4**Boccola a Pressare (skive)**

Product number	hose I.D.	I.D.	Dimension		skive	valid for
	in	mm	D	L	Length	
OSI4-06	3/8	9.5	24	31	23	Four SP - Hysoflex 4K - Hysoflex 5K - Hysoflex 6K
OSI4-08	1/2	12.7	27.6	33	24.5	Four SP - Hysoflex 4K - Hysoflex 5K - Hysoflex 6K
OSI4-10	5/8	15.9	32	36	27.5	Four SP - Hysoflex 4K
OSI4-12	3/4	19	36.4	42	32.5	Four SP - Hysoflex 4K
OSI4-16	1	25.4	44	55.5	44	Four SP - Hysoflex 4K

None

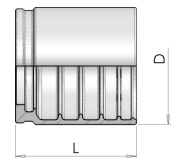
BMC1**Boccola a Pressare (non skive)**

Product number	hose I.D.	I.D.	Dimension		skive	valid for
	in	mm	D	L	Length	
BMC1-12	3/4	19	45	41	NO	R12
BMC1-16	1	25.4	53.5	56	NO	R12-4SP-4SH
BMC1-20	1.1/4	31.8	62	62	NO	(4SH)

BMC2

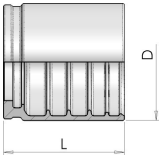

Boccola a Pressare (non skive)

Product number	hose I.D.	I.D.	Dimension		skive	valid for
	in	mm	D	L	Length	-
BMC2-20	1.1/4	31.8	66	62	NO	R12-4SP
BMC2-24	1.1/2	38.1	73.3	70	NO	R12-4SP-(R13)

0007

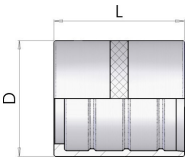

Boccola a Pressare (non skive)

Product number	hose I.D.	I.D.	Dimension		skive	valid for
	in	mm	D	L	Length	-
0007-03	3/16	4.8	14	27	NO	R7-R6-1TE-2TE
0007-04	1/4	6.4	17	29	NO	R7-R6-1TE-2TE
0007-05	5/16	7.9	19	30	NO	R7-R6-1TE-2TE
0007-06	3/8	9.5	21	31	NO	R7-R6-1TE-2TE
0007-08	1/2	12.7	25.4	34	NO	R7-R6-1TE-2TE
0007-10	5/8	15.9	28.5	36	NO	R7-R6-1TE-2TE
0007-12	3/4	19	32	36	NO	R7-R6-1TE-2TE
0007-16	1	25.4	40	50	NO	R7-R6-1TE-2TE

0008

Boccola a Pressare (non skive)

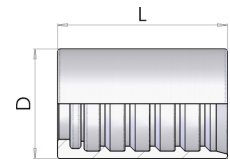

Product number	hose I.D.	I.D.	Dimension		skive	valid for
	in	mm	D	L	Length	-
0008-03	3/16	4.8	13	25	NO	R8
0008-04	1/4	6.4	17	29	NO	R8
0008-05	5/16	7.9	19	30	NO	R8
0008-06	3/8	9.5	21.5	31	NO	R8
0008-08	1/2	12.7	26	34	NO	R8
0008-10	5/8	15.9	29	40	NO	R8
0008-12	3/4	19	32	42	NO	R8
0008-16	1	25.4	40	50	NO	R8

None

0003

Boccola a Pressare (non skive)

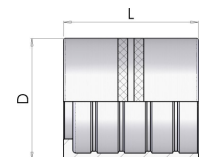

Product number	hose I.D.	I.D.	Dimension		skive	valid for
	in	mm	D	L	Length	-
0003-03	3/16	4.8	14	27	NO	R3-3TE-R5
0003-04	1/4	6.4	19	29	NO	R3-3TE-R5
0003-05	5/16	7.9	22	30	NO	R3-3TE-R5
0003-06	3/8	9.5	24	31	NO	R3-3TE-R5
0003-08	1/2	12.7	28.5	34	NO	R3-3TE-R5
0003-10	5/8	15.9	32	36	NO	R3-3TE-R5
0003-12	3/4	19	38	42	NO	R3-3TE-R5
0003-16	1	25.4	46	50	NO	R3-3TE
0003-20	1.1/4	31.8	52	57	NO	R3-3TE

PTFE

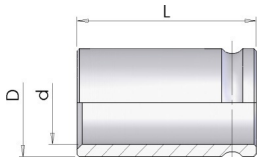

Boccola per tubo PTFE

Product number	hose I.D.	Dimension			I.D.	skive	valid for
	in	D	mm	L	d-int	Length	-
PTFE-03	3/16	12.7	4.8	22	9.5	NO	PTFE type T1
PTFE-04	1/4	14.4	6.4	23.9	11.1	NO	PTFE type T1
PTFE-05	5/16	17.1	7.9	24.6	13	NO	PTFE type T1
PTFE-06	3/8	19	9.5	27.4	15	NO	PTFE type T1
PTFE-08	1/2	22.4	12.7	28.7	18.3	NO	PTFE type T1
PTFE-10	5/8	27	15.9	31.7	23.1	NO	PTFE type T1
PTFE-12	3/4	28.7	19	34.5	24.8	NO	PTFE type T1
PTFE-16	1	38.1	25.4	43.6	34.3	NO	PTFE type T1

Per tubo PTFE tipo T1 - (con raccordi standard)

PTFE-C

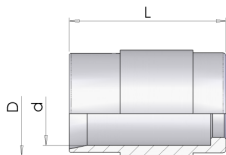

Boccola per tubo PTFE

Product number	hose I.D.	Dimension			I.D.	skive	valid for
	in	D	mm	L	d-int	Length	-
PTFE-04-C	1/4	17.8	6.4	26.5	14.4	NO	PTFE type LTC
PTFE-06-C	3/8	20	9.5	30.5	16.8	NO	PTFE type LTC
PTFE-08-C	1/2	24	12.7	33.2	20.5	NO	PTFE type LTC
PTFE-10-C	5/8	29.2	15.9	34.8	25.4	NO	PTFE type LTC
PTFE-12-C	3/4	31.1	19	40.9	27.4	NO	PTFE type LTC
PTFE-16-C	1	38.5	25.4	47	34.7	NO	PTFE type LTC

Per tubo PTFE tipo LTC - (con raccordi standard)

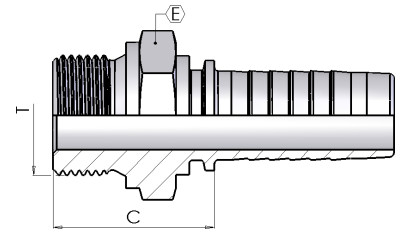
0345**Maschio BSP - Sede Piana****(AGR-F)**

Product number	hose I.D.	Dimension				I.D.
	in	dash size	mm	T	E	Cut-off C
0345-04-04	1/4	04	6.4	1/4-19	19	27
0345-05-06	5/16	05	7.9	3/8-19	22	28
0345-06-06	3/8	06	9.5	3/8-19	22	29
0345-06-08	3/8	06	9.5	1/2-14	27	32
0345-08-08	1/2	08	12.7	1/2-14	27	33
0345-10-12	5/8	10	15.9	3/4-14	32	35
0345-12-12	3/4	12	19	3/4-14	32	36
0345-12-16	3/4	12	19	1-11	41	39
0345-16-16	1	16	25.4	1-11	41	40

None

0060

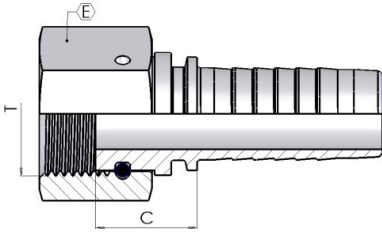

Femmina BSP Sede Piana

(DKR-F)

Product number	hose I.D.		I.D.	Dimension		
	in	mm		dash size	T	E
0060-04-04	1/4	6.4	04	1/4-19	19	14
0060-04-06	1/4	6.4	04	3/8-19	22	15
0060-05-06	5/16	7.9	05	3/8-19	22	15
0060-05-08	5/16	7.9	05	1/2-14	27	17
0060-06-06	3/8	9.5	06	3/8-19	22	15
0060-06-08	3/8	9.5	06	1/2-14	27	16
0060-08-08	1/2	12.7	08	1/2-14	27	16
0060-08-12	1/2	12.7	08	3/4-14	32	23
0060-10-10	5/8	15.9	10	5/8-14	30	16
0060-10-12	5/8	15.9	10	3/4-14	32	20
0060-12-12	3/4	19	12	3/4-14	32	21
0060-12-16	3/4	19	12	1-11	38	23
0060-16-16	1	25.4	16	1-11	38	22

None

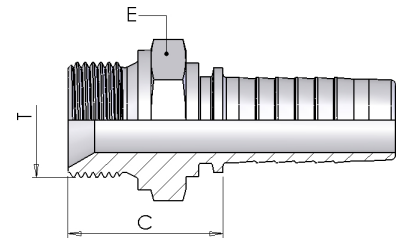
Maschio BSP svas. 60°**(AGR)**

Product number	hose I.D.		Dimension			I.D.
	in	dash size	mm	T	E	Cut-off C
0350-03-02	3/16	03	4.8	1/8-28	14	21
0350-03-04	3/16	03	4.8	1/4-19	19	26
0350-04-02	1/4	04	6.4	1/8-28	14	21
0350-04-04	1/4	04	6.4	1/4-19	19	27
0350-04-06	1/4	04	6.4	3/8-19	22	28
0350-04-08	1/4	04	6.4	1/2-14	27	35
0350-05-04	5/16	05	7.9	1/4-19	19	27
0350-05-06	5/16	05	7.9	3/8-19	22	28
0350-05-08	5/16	05	7.9	1/2-14	27	32
0350-06-04	3/8	06	9.5	1/4-19	19	27
0350-06-06	3/8	06	9.5	3/8-19	22	29
0350-06-08	3/8	06	9.5	1/2-14	27	32
0350-08-06	1/2	08	12.7	3/8-19	22	29
0350-08-08	1/2	08	12.7	1/2-14	27	33
0350-08-10	1/2	08	12.7	5/8-14	30	34
0350-08-12	1/2	08	12.7	3/4-14	32	35
0350-10-08	5/8	10	15.9	1/2-14	27	33
0350-10-10	5/8	10	15.9	5/8-14	30	35
0350-10-12	5/8	10	15.9	3/4-14	32	35
0350-12-08	3/4	12	19	1/2-14	27	33
0350-12-12	3/4	12	19	3/4-14	32	36
0350-12-16	3/4	12	19	1-11	41	39
0350-16-16	1	16	25.4	1-11	41	40
0350-16-20	1	16	25.4	1.1/4-11	50	44
0350-20-16	1.1/4	20	31.8	1-11	41	41
0350-20-20	1.1/4	20	31.8	1.1/4-11	50	45
0350-20-24	1.1/4	20	31.8	1.1/2-11	55	46
0350-24-24	1.1/2	24	38.1	1.1/2-11	55	46
0350-24-32	1.1/2	24	38.1	2-11	70	54
0350-32-24	2	32	50.8	1.1/2-11	65	50
0350-32-32	2	32	50.8	2-11	70	54

None

035G

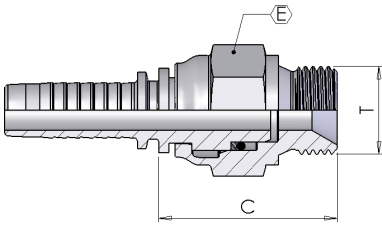

Maschio BSP Svas.60° - girevole

(AGR-RO)

Product number	hose I.D.	I.D.	Dimension			
	in	mm	dash size	T	E	Cut-off C
035G-04-04	1/4	6.4	04	1/4-19	19	37
035G-06-06	3/8	9.5	06	3/8-19	22	43
035G-08-08	1/2	12.7	08	1/2-14	27	47
035G-12-12	3/4	19	12	3/4-14	32	52

0050

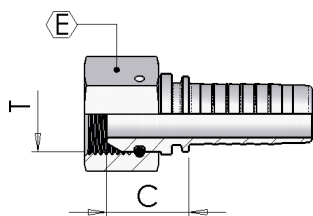

0051

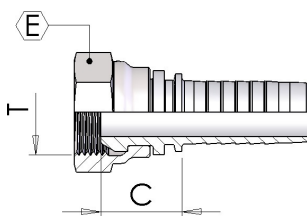

0058

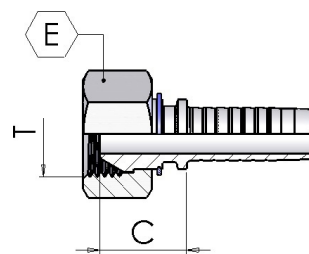

Femmina BSP cono 60°

(DKR)

Product number	hose I.D.		Dimension			
	in	mm	dash size	Thread T	hex E	Cut-off C
0051-03-02	3/16	4.8	03	1/8-28	14	15
0058-03-04	3/16	4.8	03	1/4-19	19	17
0051-04-02	1/4	6.4	04	1/8-28	14	15
0058-04-04	1/4	6.4	04	1/4-19	19	21
0058-04-06	1/4	6.4	04	3/8-19	22	21
0051-05-04	5/16	9.5	05	1/4-19	19	19
0058-05-06	5/16	7.9	05	3/8-19	22	21
0058-05-08	5/16	7.9	05	1/2-14	27	22
0051-06-04	3/8	9.5	06	1/4-19	19	17
0058-06-06	3/8	9.5	06	3/8-19	22	21
0058-06-08	3/8	9.5	06	1/2-14	27	23
0051-08-06	1/2	12.7	08	3/8-19	22	20
0058-08-08	1/2	12.7	08	1/2-14	27	23
0051-08-10	1/2	12.7	08	5/8-14	30	20
0051-08-12	1/2	12.7	08	3/4-14	32	27
0051-10-08	5/8	15.9	10	1/2-14	27	23
0051-10-10	5/8	15.9	10	5/8-14	30	20
0051-10-12	5/8	15.9	10	3/4-14	32	25
0051-12-08	3/4	19	12	1/2-14	27	24
0051-12-12	3/4	19	12	3/4-14	32	25
0051-12-16	3/4	19	12	1-11	38	26
0051-16-12	1	25.4	16	3/4-14	32	27
0051-16-16	1	25.4	16	1-11	38	27
0050-16-20	1	25.4	16	1.1/4-11	50	30
0050-20-20	1.1/4	31.8	20	1.1/4-11	50	32
0050-20-24	1.1/4	31.8	20	1.1/2-11	55	34
0050-24-24	1.1/2	38.1	24	1.1/2-11	55	34
0050-24-32	1.1/2	38.1	24	2-11	70	34
0050-32-32	2	50.8	32	2-11	70	31
0050-40-40	2.1/2	63.5	40	2.1/2-11	85	41
0050-48-48	3	76.2	25,8	3-11	100	45

None

0051D

Femmina BSP cono 60° Doppio esagono

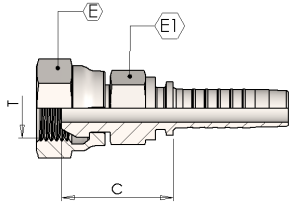

Product number	hose I.D.		Dimension				
	in	mm	dash size	T	E	E1	C
0051D04-04	1/4	6,4	04	1/4-19	19	14	22
0051D06-06	3/8	9,5	06	3/8-19	22	17	28
0051D08-08	1/2	12,7	08	1/2-14	27	22	30
0051D12-12	3/4	19	12	3/4-14	32	27	35

None

0150

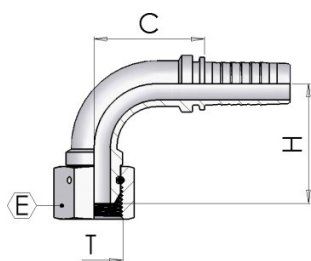

0151

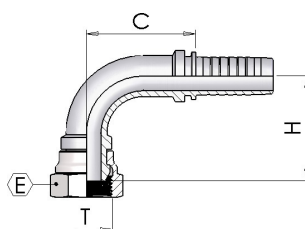

0158

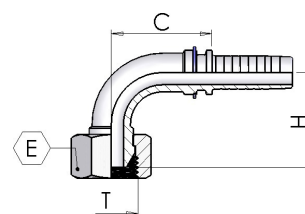

Curva BSP 90° cono 60°

Product number	hose I.D.		Dimension				
	in	mm	dash size	T	E	H	Cut-off C
0151-03-02	3/16	4.8	03	1/8-28	14	23	23
0151-03-04	3/16	4.8	03	1/4-19	19	25	25
0151-04-02	1/4	6.4	04	1/8-28	14	25	25
0158-04-04	1/4	6.4	04	1/4-19	19	21	27
0158-04-06	1/4	6.4	04	3/8-19	22	24	27
0151-05-04	5/16	7.9	05	1/4-19	19	31	31
0158-05-06	5/16	7.9	05	3/8-19	22	29	31
0151-06-04	3/8	9.5	06	1/4-19	19	33	31
0158-06-06	3/8	9.5	06	3/8-19	22	29	33
0158-06-08	3/8	9.5	06	1/2-14	27	31	36
0151-08-06	1/2	12.7	08	3/8-19	22	42	39
0158-08-08	1/2	12.7	08	1/2-14	27	37.5	38.5
0151-08-10	1/2	12.7	08	5/8-14	30	41	40
0151-08-12	1/2	12.7	08	3/4-14	32	46	41
0151-10-10	5/8	15.9	10	5/8-14	30	43	43
0151-10-12	5/8	15.9	10	3/4-14	32	50	45
0151-12-12	3/4	19	12	3/4-14	32	57	56
0151-12-16	3/4	19	12	1-11	38	56	56
0151-16-16	1	25.4	16	1-11	38	67	70
0150-20-20	1.1/4	31.8	20	1.1/4-11	50	84	83
0150-24-24	1.1/2	38.1	24	1.1/2-11	55	95	103
0150-32-32	2	50.8	32	2-11	70	124	133

None

0250

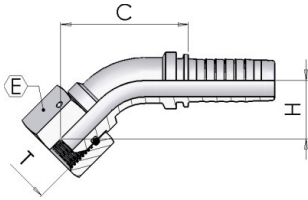

0251

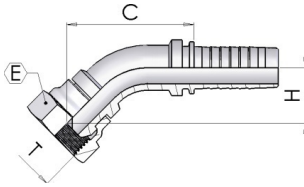

0258

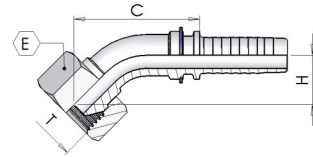

Curva BSP 45° cono 60°

(DKR-45°)

Product number	hose I.D.		Dimension				
	in	mm	dash size	T	E	H	C
0251-03-02	3/16	4.8	03	1/8-28	14	15	33
0251-04-02	1/4	6.4	04	1/8-28	14	14	40
0258-04-04	1/4	6.4	04	1/4-19	19	14	39
0258-04-06	1/4	6.4	04	3/8-19	22	16	41
0251-05-04	5/16	7.9	05	1/4-19	19	16	47
0251-06-04	3/8	9.5	06	1/4-19	19	19	50
0258-06-06	3/8	9.5	06	3/8-19	22	17	47
0258-06-08	3/8	9.5	06	1/2-14	27	16	52
0251-08-06	1/2	12.7	08	3/8-19	22	22	63
0258-08-08	1/2	12.7	08	1/2-14	27	19	61
0251-08-10	1/2	12.7	08	5/8-14	30	21	64
0251-08-12	1/2	12.7	08	3/4-14	32	26	67
0251-10-08	5/8	15.9	10	1/2-14	27	24	68
0251-10-10	5/8	15.9	10	5/8-14	30	23	68
0251-10-12	5/8	15.9	10	3/4-14	32	27	72
0251-12-12	3/4	19	12	3/4-14	32	28	88
0251-12-16	3/4	19	12	1-11	38	32	88
0251-16-16	1	25.4	16	1-11	38	30	88
0250-20-20	1.1/4	31.8	20	1.1/4-11	50	40	107
0250-24-24	1.1/2	38.1	24	1.1/2-11	55	51	117
0250-32-32	2	50.8	32	2-11	70	59	146

None

2321

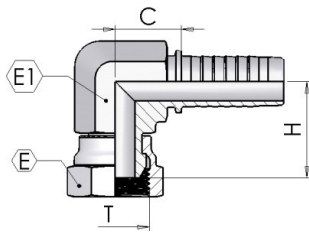

2300

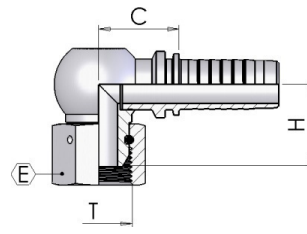

Compatta BSP 90° cono 60°

Product number	hose I.D.		Dimension					
	in	mm	dash size	T	E	E1	H	C
2321-03-02	3/16	4.8	03	1/8-28	14	12	18	17
2321-03-04	3/16	4.8	03	1/4-19	19	14	20	17
2321-04-04	1/4	6.4	04	1/4-19	19	15	20	19
2321-04-06	1/4	6.4	04	3/8-19	22	17	29	24
2321-05-06	5/16	7.9	05	3/8-19	22	17	23	24
2321-06-06	3/8	9.5	06	3/8-19	22	17	23	23
2321-06-08	3/8	9.5	06	1/2-14	27	19	26	28
2321-08-08	1/2	12.7	08	1/2-14	27	22	27	26
2321-10-10	5/8	15.9	10	5/8-14	30	24	28	29
2321-12-12	3/4	19	12	3/4-14	32	27	32	32
2321-16-16	1	25.4	16	1-11	38	32	36	38
2300-20-20	1.1/4	31.8	20	1.1/4-11	50	-	46	47

None

0041

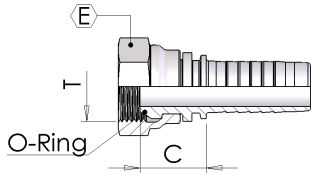

0048

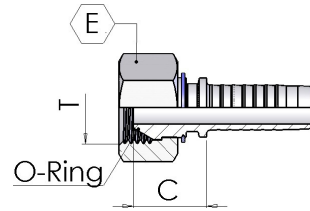

Femmina BSP cono 60° con O-Ring

(DKR-OR)

Product number	hose I.D.		Dimension			
	in	mm	dash size	Thread T	hex E	Cut-off C
0048-04-04	1/4	6.4	04	1/4-19	19	22
0048-04-06	1/4	6.4	04	3/8-19	22	20
0048-06-06	3/8	9.5	06	3/8-19	22	20
0048-06-08	3/8	9.5	06	1/2-14	27	23
0048-08-08	1/2	12.7	08	1/2-14	27	23
0041-10-10	5/8	15.9	10	5/8-14	30	21
0041-12-12	3/4	19	12	3/4-14	32	26
0041-16-16	1	25.4	16	1-11	38	28

None

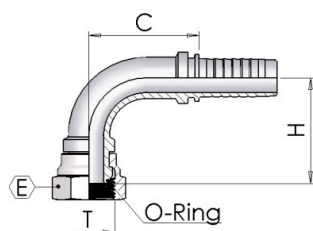
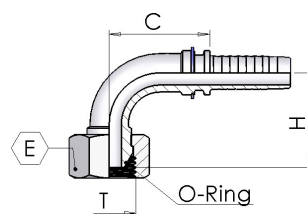
0141**0148**

Curva BSP 90° cono 60° con O-Ring

(DKR-OR 90°)

Product number	hose I.D.		Dimension				
	in	mm	dash size	T	E	H	C
0148-04-04	1/4	6.4	04	1/4-19	19	22	27
0148-04-06	1/4	6.4	04	3/8-19	22	23	27
0148-06-06	3/8	9.5	06	3/8-19	22	23	27
0148-06-08	3/8	9.5	06	1/2-14	27	30	33
0148-08-08	1/2	12.7	08	1/2-14	27	35	42
0141-10-10	5/8	15.9	10	5/8-14	30	54	37
0141-12-12	3/4	19	12	3/4-14	32	58	56
0141-16-16	1	25.4	16	1-11	38	67	70

None

0241

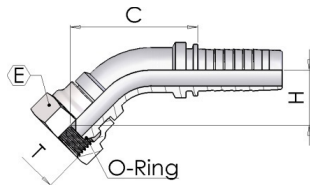

0248

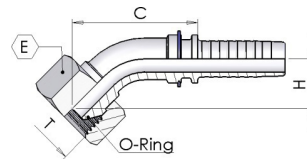

Curva BSP 45° cono 60° con O-Ring (DKR-OR 45°)

Product number	hose I.D.		Dimension				
	in	mm	dash size	T	E	H	C
0248-04-04	1/4	6.4	04	1/4-19	19	15	41
0248-06-06	3/8	9.5	06	3/8-19	22	15	47
0248-08-08	1/2	12.7	08	1/2-14	27	19	61
0241-12-12	3/4	19	12	3/4-14	32	28	88
0241-16-16	1	25.4	16	1-11	38	32	114

None

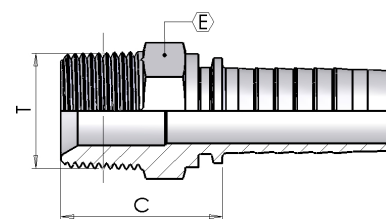
0360**Maschio BSPT svas. 60°****(AGR-K)**

Product number	hose I.D.	I.D.	Dimension			
	in	mm	dash size	T	E	Cut-off C
0360-03-02	3/16	4.8	03	1/8-28	12	21
0360-03-04	3/16	4.8	03	1/4-19	15	27
0360-04-02	1/4	6.4	04	1/8-28	12	22
0360-04-04	1/4	6.4	04	1/4-19	15	28
0360-04-06	1/4	6.4	04	3/8-19	19	28
0360-05-04	5/16	7.9	05	1/4-19	15	28
0360-05-06	5/16	7.9	05	3/8-19	19	28
0360-06-04	3/8	9.5	06	1/4-19	17	28
0360-06-06	3/8	9.5	06	3/8-19	19	28
0360-06-08	3/8	9.5	06	1/2-14	22	33
0360-08-06	1/2	12.7	08	3/8-19	19	29
0360-08-08	1/2	12.7	08	1/2-14	22	34
0360-08-12	1/2	12.7	08	3/4-14	27	36
0360-12-12	3/4	19	12	3/4-14	27	37
0360-12-16	3/4	19	12	1-11	36	43
0360-16-16	1	25.4	16	1-11	36	44
0360-20-20	1.1/4	31.8	20	1.1/4-11	46	47
0360-24-24	1.1/2	38.1	24	1.1/2-11	50	49
0360-32-32	2	50.8	32	2-11	65	55

None

0370

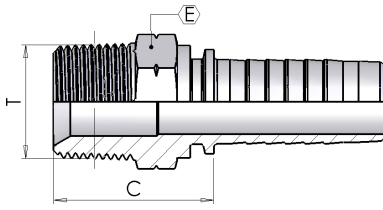

Maschio NPTF svas. 60°

(AGN)

Product number	hose I.D.		Dimension			
	in	mm	dash size	Cut-off C	T	E
0370-03-02	3/16	4.8	03	22	1/8-27	12
0370-03-04	3/16	4.8	03	27	1/4-18	15
0370-04-02	1/4	6.4	04	22	1/8-27	12
0370-04-04	1/4	6.4	04	28	1/4-18	15
0370-04-06	1/4	6.4	04	28	3/8-18	19
0370-05-04	5/16	7.9	05	28	1/4-18	15
0370-05-06	5/16	7.9	05	28	3/8-18	19
0370-06-04	3/8	9.5	06	28	1/4-18	17
0370-06-06	3/8	9.5	06	28	3/8-18	19
0370-06-08	3/8	9.5	06	34	1/2-14	22
0370-08-06	1/2	12.7	08	29	3/8-18	19
0370-08-08	1/2	12.7	08	35	1/2-14	22
0370-08-12	1/2	12.7	08	36	3/4-14	27
0370-10-08	5/8	15.9	10	35	1/2-14	24
0370-10-12	5/8	15.9	10	36	3/4-14	27
0370-12-08	3/4	19	12	36	1/2-14	24
0370-12-12	3/4	19	12	37	3/4-14	27
0370-12-16	3/4	19	12	43	1-11.1/2	36
0370-16-16	1	25.4	16	44	1-11.1/2	36
0370-20-20	1.1/4	31.8	20	47	1.1/4-11.1/2	46
0370-24-24	1.1/2	38.1	24	49	1.1/2-11.1/2	50
0370-32-32	2	50.8	32	55	2-11.1/2	65
0370-40-40	2.1/2	63.5	40	55	2.1/2-8	80
0370-48-48	3	76.2	48	58	3-8	90

None

037G

Maschio NPTF Svas.60° - girevole

(AGN-RO)

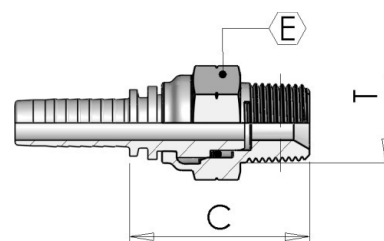

Product number	hose I.D.		I.D.	Dimension		
	in	mm		dash size	T	E
037G-04-04	1/4	6.4	04	1/4-18	19	39
037G-06-06	3/8	9.5	06	3/8-18	22	43
037G-08-08	1/2	12.7	08	1/2-14	27	49
037G-12-12	3/4	19	12	3/4-14	32	52

N051

Femmina NPSM cono 60° dado rullato

(DKN)

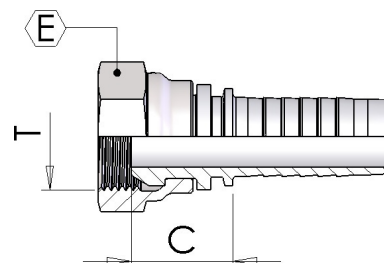

Product number	hose I.D.		I.D.	Dimension		
	in	mm		dash size	T	E
N051-03-04	3/16	4.8	03	1/4-18	19	17
N051-04-04	1/4	6.4	04	1/4-18	19	17
N051-06-06	3/8	9.5	06	3/8-18	22	19
N051-08-08	1/2	12.7	08	1/2-14	27	23
N051-12-12	3/4	19.1	12	3/4-14	32	25
N051-16-16	1	25.4	16	1-11	38	27

None

0850

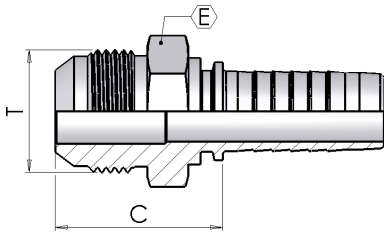

Maschio JIC cono 74°

(AGJ)

Product number	hose I.D.		I.D.	Dimension		
	in	mm		dash size	T	E
0850-03-04	3/16	4.8	03	7/16-20	12	26
0850-04-04	1/4	6.4	04	7/16-20	12	27
0850-04-05	1/4	6.4	04	1/2-20	14	27
0850-04-06	1/4	6.4	04	9/16-18	15	27
0850-05-05	5/16	7.9	05	1/2-20	14	27
0850-05-06	5/16	7.9	05	9/16-18	15	27
0850-05-08	5/16	7.9	05	3/4-16	19	30
0850-06-06	3/8	9.5	06	9/16-18	15	27
0850-06-07	3/8	9.5	06	5/8-18	17	30
0850-06-08	3/8	9.5	06	3/4-16	19	30
0850-06-10	3/8	9.5	06	7/8-14	24	34
0850-08-08	1/2	12.7	08	3/4-16	19	31
0850-08-10	1/2	12.7	08	7/8-14	24	35
0850-08-12	1/2	12.7	08	1.1/16-12	27	37
0850-10-10	5/8	15.9	10	7/8-14	24	35
0850-10-12	5/8	15.9	10	1.1/16-12	27	37
0850-12-10	3/4	19	12	7/8-14	24	36
0850-12-12	3/4	19	12	1.1/16-12	27	38
0850-12-14	3/4	19	12	1.3/16-12	32	41
0850-12-16	3/4	19	12	1.5/16-12	34	42
0850-16-12	1	25.4	16	1.1/16-12	27	39
0850-16-16	1	25.4	16	1.5/16-12	34	43
0850-16-20	1	25.4	16	1.5/8-12	42	46
0850-20-20	1.1/4	31.8	20	1.5/8-12	42	47
0850-20-24	1.1/4	31.8	20	1.7/8-12	50	52
0850-24-24	1.1/2	38.1	24	1.7/8-12	50	52
0850-32-32	2	50.8	32	2.1/2-12	65	62

None

0900

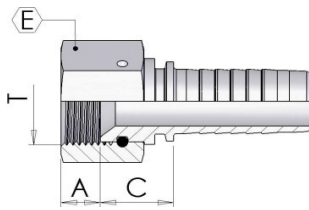

0901

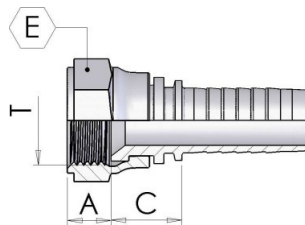

0902

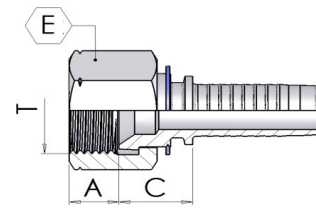

Femmina JIC svas. 74°

(DKJ)

Product number	hose I.D.		Dimension				
	in	mm	dash size	T	E	Cut-off C	A
0901-03-04	3/16	4.8	03	7/16-20	15	14	8.5
0901-03-05	3/16	4.8	03	1/2-20	17	14	9.5
0901-04-04	1/4	6.4	04	7/16-20	15	14	8.5
0902-04-05	1/4	6.4	04	1/2-20	17	17	9.5
0902-04-06	1/4	6.4	04	9/16-18	19	17	9
0901-04-07	1/4	6.4	04	5/8-18	22	17	11
0901-05-05	5/16	7.9	05	1/2-20	17	17	9.5
0901-05-07	5/16	7.9	05	5/8-18	22	17	11
0901-06-04	3/8	9.5	06	7/16-20	15	15	9
0901-06-05	3/8	9.5	06	1/2-20	17	15	9.5
0901-06-06	3/8	9.5	06	9/16-18	19	16	9
0901-06-07	3/8	9.5	06	5/8-18	22	16	11
0902-06-08	3/8	9.5	06	3/4-16	22	18	10.5
0901-08-08	1/2	12.7	08	3/4-16	24	18	10.5
0902-08-10	1/2	12.7	08	7/8-14	27	20	13
0901-10-10	5/8	15.9	10	7/8-14	27	20	13
0902-10-12	5/8	15.9	10	1.1/16-12	32	20	13.5
0901-12-10	3/4	19	12	7/8-14	27	20	13
0902-12-12	3/4	19	12	1.1/16-12	32	22	13.5
0901-12-14	3/4	19	12	1.3/16-12	36	23	14
0901-12-16	3/4	19	12	1.5/16-12	38	23	15.5
0901-16-12	1	25.4	12	1.1/16-12	32	23	13.5
0901-16-16	1	25.4	16	1.5/16-12	38	24	15.5
0900-16-20	1	25.4	16	1.5/8-12	50	27	16.5
0900-20-20	1.1/4	31.8	20	1.5/8-12	50	28	16.5
0900-20-24	1.1/4	31.8	20	1.7/8-12	55	31	19
0900-24-24	1.1/2	38.1	24	1.7/8-12	55	31	19
0900-32-32	2	50.8	32	2.1/2-12	70	31	20

None

0901D

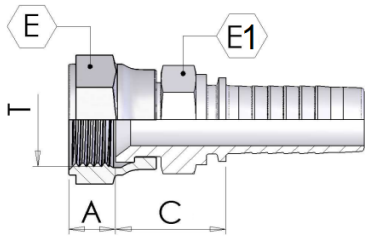

Femmina JIC svas. 74° - Doppio esagono

(DKJ)

Product number	hose I.D.		Dimension					
	in	mm	dash size	T	E	E1	C	A
0901D04-04	1/4	6.4	04	7/16-20	15	12	20	8.5
0901D04-05	1/4	6.4	04	1/2-20	17	14	20	9.5
0901D04-06	1/4	6.4	04	9/16-18	19	14	22	9
0901D06-06	3/8	9.5	06	9/16-18	19	17	24	9
0901D06-08	3/8	9.5	06	3/4-16	24	19	26	10.5
0901D08-08	1/2	12.7	08	3/4-16	24	22	26	10.5
0901D08-10	1/2	12.7	08	7/8-14	27	22	27	13
0901D10-10	5/8	15.9	10	7/8-14	27	22	26	13
0901D10-12	5/8	15.9	10	1.1/16-12	32	27	27	13.5
0901D12-12	3/4	19	12	1.1/16-12	32	27	32	13.5
0901D16-16	1	25.4	16	1.5/16-12	38	36	33	15.5

None

0950

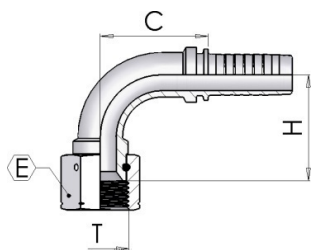

0951

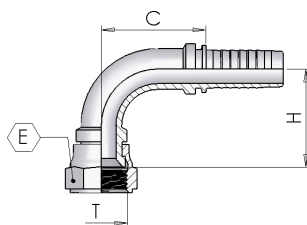

0952

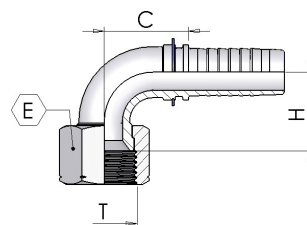

Curva JIC 90° svas.74°

Product number	hose I.D.		Dimension				
	in	mm	dash size	T	E	H	C
0951-03-04	3/16	4.8	03	7/16-20	15	22	22
0951-03-05	3/16	4.8	03	1/2-20	17	22	22
0951-04-04	1/4	6.4	04	7/16-20	15	22	22
0952-04-05	1/4	6.4	04	1/2-20	17	21	27
0952-04-06	1/4	6.4	04	9/16-18	19	21	26
0951-05-05	5/16	7.9	05	1/2-20	17	30	29
0951-05-06	5/16	7.9	05	9/16-18	19	31	29
0951-06-05	3/8	9.5	06	1/2-20	17	33	30
0951-06-06	3/8	9.5	06	9/16-18	19	32	31
0951-06-07	3/8	9.5	06	5/8-18	22	32	33
0952-06-08	3/8	9.5	06	3/4-16	22	34	41
0951-06-10	3/8	9.5	06	7/8-14	27	36	33
0951-08-08	1/2	12.7	08	3/4-16	24	41	41
0952-08-10	1/2	12.7	08	7/8-14	27	34	41
0951-08-12	1/2	12.7	08	1.1/16-12	32	43	42
0951-10-10	5/8	15.9	10	7/8-14	27	44	43
0951-12-10	3/4	19	12	7/8-14	27	53	56
0952-10-12	5/8	15.9	10	1.1/16-12	32	37	47
0952-12-12	3/4	19	12	1.1/16-12	32	45	58
0951-12-14	3/4	19	12	1.3/16-12	36	53	56
0951-12-16	3/4	19	12	1.5/16-12	38	55	60
0951-16-12	1	25.4	16	1.1/16-12	38	55	60
0951-16-16	1	25.4	16	1.5/16-12	32	63	70
0950-20-20	1.1/4	31.8	20	1.5/8-12	50	85	82
0950-24-24	1.1/2	38.1	24	1.7/8-12	55	97	104
0950-32-32	2	50.8	32	2.1/2-12	70	134	124

None

1000

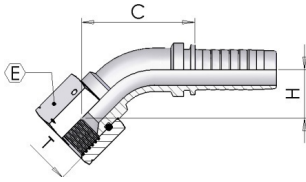

1001

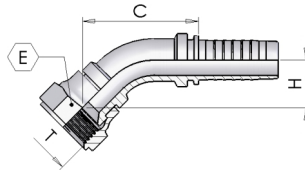

1002

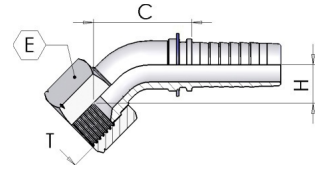

Curva JIC 45° svas.74°

(DKJ-45°)

Product number	hose I.D.		Dimension				
	in	mm	dash size	T	E	H	C
1001-03-04	3/16	4.8	03	7/16-20	15	15	33
1001-04-04	1/4	6.4	04	7/16-20	15	13	38
1002-04-05	1/4	6.4	04	1/2-20	17	11	38
1002-04-06	1/4	6.4	04	9/16-18	19	11	38
1001-05-05	5/16	7.9	05	1/2-20	17	17	46
1001-05-06	5/16	7.9	05	9/16-18	19	18	47
1001-06-05	3/8	9.5	06	1/2-20	17	18	49
1001-06-06	3/8	9.5	06	9/16-18	19	17	51
1002-06-08	3/8	9.5	06	3/4-16	22	13	48
1001-06-10	3/8	9.5	06	7/8-14	27	21	54
1001-08-08	1/2	12.7	08	3/4-16	24	22	62
1002-08-10	1/2	12.7	08	7/8-14	27	16	58
1001-08-12	1/2	12.7	08	1.1/16-12	32	25	68
1001-10-10	5/8	15.9	10	7/8-14	27	24	68
1002-10-12	5/8	15.9	10	1.1/16-12	32	18	66
1002-12-12	3/4	19	12	1.1/16-12	32	21	81
1001-12-14	3/4	19	12	1.3/16-12	36	29	84
1001-12-16	3/4	19	12	1.5/16-12	38	28	88
1001-16-16	1	25.4	16	1.5/16-12	38	29	83
1000-20-20	1.1/4	31.8	20	1.5/8-12	50	42	108
1000-24-24	1.1/2	38.1	24	1.7/8-12	55	49	156
1000-32-32	2	50.8	32	2.1/2-12	70	65	142

None

095S

Curva JIC 90° svas.74° - ISO SHORT

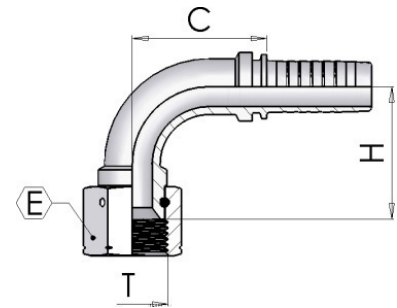

Product number	hose I.D.		Dimension				
	in	mm	dash size	T	E	H	C
095S-04-04	1/4	6.4	04	7/16-20	15	22	25
095S-06-06	3/8	9.5	06	9/16-18	19	23	31
095S-08-08	1/2	12.7	08	3/4-16	24	29	41
095S-10-10	5/8	15.9	10	7/8-14	27	32	43
095S-12-12	3/4	19	12	1.1/16-12	32	48	56
095S-16-16	1	25.4	16	1.5/16-12	41	57	70

None

2971

Compatta JIC 90° svas.74° - Dado crimpato (DKJ-90°K)

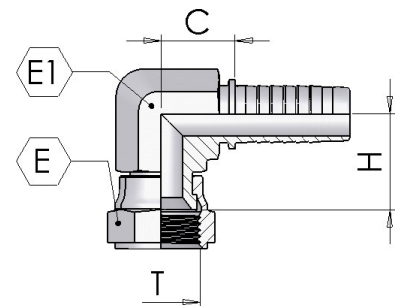

Product number	hose I.D.		Dimension					
	in	mm	dash size	T	E	E1	H	C
2971-04-04	1/4	6.4	04	7/16-20	15	15	17	19
2971-04-05	1/4	6.4	04	1/2-20	17	15	18	19
2971-04-06	1/4	6.4	04	9/16-18	19	15	19	19
2971-05-06	5/16	7.9	05	9/16-18	19	17	20	20
2971-06-06	3/8	9.5	06	9/16-18	19	17	20	23
2971-06-08	3/8	9.5	06	3/4-16	24	19	22	24
2971-08-08	1/2	12.7	08	3/4-16	24	22	22.5	26.5
2971-08-10	1/2	12.7	08	7/8-14	27	22	23.5	26.5
2971-12-12	3/4	19.1	12	1.1/16-12	32	27	28.5	31.5
2971-16-16	1	25.4	16	1.5/16-12	38	32	33.5	37.5

None

0385

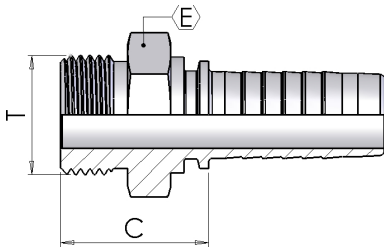

Maschio SAE O'R Sede Piana

(SAE-OR)

Product number	hose I.D.	I.D.	Dimension			
	in	mm	dash size	T	E	Cut-off C
0385-04-04	1/4	6.4	04	7/16-20	14	24
0385-04-06	1/4	6.4	04	9/16-18	17	24
0385-05-06	5/16	7.9	05	9/16-18	17	24
0385-06-06	3/8	9.5	06	9/16-18	17	25
0385-06-08	3/8	9.5	06	3/4-16	22	28
0385-08-08	1/2	12.7	08	3/4-16	22	28
0385-08-10	1/2	12.7	08	7/8-14	27	30
0385-08-12	1/2	12.7	08	1.1/16-12	32	32
0385-10-10	5/8	15.9	10	7/8-14	27	30
0385-10-12	5/8	15.9	10	1.1/16-12	32	32
0385-12-12	3/4	19	12	1.1/16-12	32	33

Maschio Metrico svas. 24° Serie Leggera

(CEL)

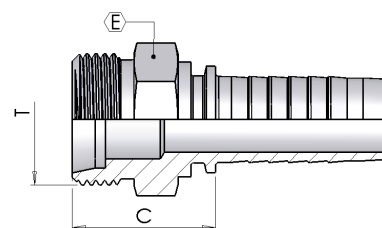

Product number	hose I.D.		Dimension				I.D. Cut-off C
	in	dash size	mm	T	erm.	E	
0500-03-12	3/16	03	4.8	M12-1.5	6	14	22
0500-03-14	3/16	03	4.8	M14-1.5	8	14	22
0500-04-12	1/4	04	6.4	M12-1.5	6	14	23
0500-04-14	1/4	04	6.4	M14-1.5	8	14	22
0500-04-16	1/4	04	6.4	M16-1.5	10	17	23
0500-04-18	1/4	04	6.4	M18-1.5	12	19	24
0500-05-14	5/16	05	7.9	M14-1.5	8	14	22
0500-05-16	5/16	05	7.9	M16-1.5	10	17	23
0500-05-18	5/16	05	7.9	M18-1.5	12	19	24
0500-05-22	5/16	05	7.9	M22-1.5	15	22	25
0500-06-16	3/8	06	9.5	M16-1.5	10	17	23
0500-06-18	3/8	06	9.5	M18-1.5	12	19	24
0500-06-22	3/8	06	9.5	M22-1.5	15	22	25
0500-08-18	1/2	08	12.7	M18-1.5	12	19	25
0500-08-22	1/2	08	12.7	M22-1.5	15	22	26
0500-08-26	1/2	08	12.7	M26-1.5	18	27	27
0500-10-22	5/8	10	15.9	M22-1.5	15	22	26
0500-10-26	5/8	10	15.9	M26-1.5	18	27	27
0500-10-30	5/8	10	15.9	M30-2	22	30	32
0500-12-26	3/4	12	19	M26-1.5	18	27	28
0500-12-30	3/4	12	19	M30-2	22	30	33
0500-16-36	1	16	25.4	M36-2	28	36	32
0500-20-45	1.1/4	20	31.8	M45-2	35	46	36
0500-24-52	1.1/2	24	38.1	M52-2	42	55	38

None

0085

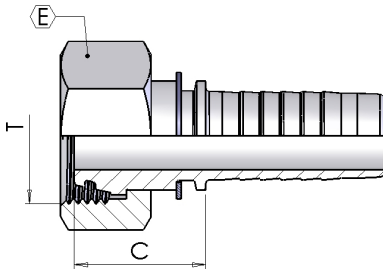

Femmina Metrica cono 24° Serie Leggera

(DKOL)

Product number	hose I.D.		Dimension				I.D.
	in	dash size	mm	T	erm.	€	Cut-off C
0085-03-12	3/16	03	4.8	M12-1.5	6	14	23
0085-03-14	3/16	03	4.8	M14-1.5	8	17	24
0085-04-12*	1/4	04	6.4	M12-1.5	6	14	25
0085-04-14	1/4	04	6.4	M14-1.5	8	17	24
0085-04-16	1/4	04	6.4	M16-1.5	10	19	24
0085-04-18	1/4	04	6.4	M18-1.5	12	22	25
0085-05-14*	5/16	05	7.9	M14-1.5	8	17	26
0085-05-16	5/16	05	7.9	M16-1.5	10	19	24
0085-05-18	5/16	05	7.9	M18-1.5	12	22	25
0085-06-16*	3/8	06	9.5	M16-1.5	10	19	25
0085-06-18	3/8	06	9.5	M18-1.5	12	22	25
0085-06-22	3/8	06	9.5	M22-1.5	15	27	29
0085-08-18*	1/2	08	12.7	M18-1.5	12	22	28
0085-08-22	1/2	08	12.7	M22-1.5	15	27	29
0085-08-26	1/2	08	12.7	M26-1.5	18	32	29
0085-10-22*	5/8	10	15.9	M22-1.5	15	27	31
0085-10-26	5/8	10	15.9	M26-1.5	18	32	29
0085-10-30	5/8	10	15.9	M30-2	22	36	29
0085-12-26*	3/4	12	19	M26-1.5	18	32	35
0085-12-30	3/4	12	19	M30-2	22	36	29
0085-12-36	3/4	12	19	M36-2	28	41	28
0085-16-36	1	16	25.4	M36-2	28	41	30
0085-20-45	1.1/4	20	31.8	M45-2	35	50	40
0085-20-52	1.1/4	20	31.8	M52-2	42	60	43
0085-24-52	1.1/2	24	38.1	M52-2	42	60	41

*Dado Pressato

0185

Curva Metrica 90° cono 24° Serie Leggera

(DKOL-90°)

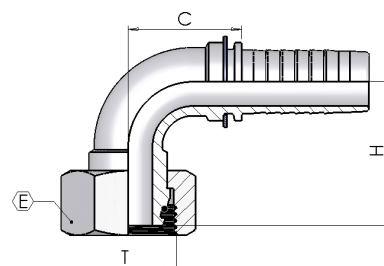

Product number	hose I.D.		Dimension					
	in	mm	dash size	T	erm.	E	H	Cut-off C
0185-03-12	3/16	4.8	03	M12-1.5	6	14	23	22
0185-03-14	3/16	4.8	03	M14-1.5	8	17	24	23
0185-04-12*	1/4	6.4	04	M12-1.5	6	14	34	26
0185-04-14	1/4	6.4	04	M14-1.5	8	17	26	26
0185-04-16	1/4	6.4	04	M16-1.5	10	19	27	25
0185-04-18	1/4	6.4	04	M18-1.5	12	22	30	27
0185-05-14*	5/16	7.9	05	M14-1.5	8	19	38	30
0185-05-16	5/16	7.9	05	M16-1.5	10	19	31	31
0185-05-18	5/16	7.9	05	M18-1.5	12	22	32	31
0185-06-16*	3/8	9.5	06	M16-1.5	10	19	39	32
0185-06-18	3/8	9.5	06	M18-1.5	12	22	35	32
0185-06-22	3/8	9.5	06	M22-1.5	15	27	35	32
0185-08-18*	1/2	9.5	08	M18-1.5	12	24	48	40
0185-08-22	1/2	12.7	08	M22-1.5	15	27	38	41
0185-08-26	1/2	12.7	08	M26-1.5	18	32	39	41
0185-10-22*	5/8	15.9	10	M22-1.5	15	27	55	42
0185-10-26	5/8	15.9	10	M26-1.5	18	32	44	44
0185-12-30	3/4	19	12	M30-2	22	36	52	58
0185-16-36	1	25.4	16	M36-2	28	41	62	72
0185-20-45	1.1/4	31.8	20	M45-2	35	50	81	84
0185-24-52	1.1/2	38.1	24	M52-2	42	60	93	102

*Dado Pressato

0285

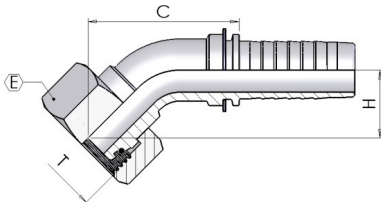

Curva Metrica 45° cono 24° Serie Leggera

(DKOL-45°)

Product number	hose I.D.		I.D.	Dimension					Cut-off C
	in	mm		dash size	T	erm.	E	H	
0285-03-12	3/16	4.8	03	M12-1.5	6	14	14	36	
0285-04-12*	1/4	6.4	04	M12-1.5	6	14	21	46	
0285-04-14	1/4	6.4	04	M14-1.5	8	17	14	42	
0285-04-16	1/4	6.4	04	M16-1.5	10	19	15	42	
0285-04-18	1/4	6.4	04	M18-1.5	12	22	16	43	
0285-05-16	5/16	7.9	05	M16-1.5	10	19	17	48	
0285-05-18	5/16	7.9	05	M18-1.5	12	22	18	48	
0285-06-16*	3/8	9.5	06	M16-1.5	10	19	22	55	
0285-06-18	3/8	9.5	06	M18-1.5	12	22	19	52	
0285-06-22	3/8	9.5	06	M22-1.5	15	27	19	51	
0285-08-22	1/2	12.7	08	M22-1.5	15	27	21	63	
0285-08-26	1/2	12.7	08	M26-1.5	18	32	22	63	
0285-10-22*	5/8	15.9	10	M22-1.5	15	27	32	75	
0285-10-26	5/8	15.9	10	M26-1.5	18	32	23	68	
0285-12-30	3/4	19	12	M30-2	22	36	25	86	
0285-16-36	1	25.4	16	M36-2	28	41	29	81	
0285-20-45	1.1/4	31.8	20	M45-2	35	50	32	106	
0285-24-52	1.1/2	38.1	24	M52-2	42	60	43	119	

*Dado Pressato

Maschio Metrico svas. 24° Serie Pesante

(CES)

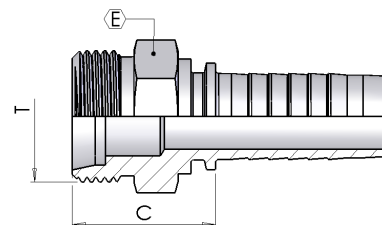

Product number	hose I.D.		Dimension				
	in	mm	dash size	T	erm.	E	Cut-off C
0450-03-16	3/16	4.8	03	M16-1.5	8	17	26
0450-04-14	1/4	6.4	04	M14-1.5	6	14	25
0450-04-16	1/4	6.4	04	M16-1.5	8	17	27
0450-04-18	1/4	6.4	04	M18-1.5	10	19	27
0450-04-20	1/4	6.4	04	M20-1.5	12	22	27
0450-05-18	5/16	7.9	05	M18-1.5	10	19	27
0450-05-20	5/16	7.9	05	M20-1.5	12	22	29
0450-06-18	3/8	9.5	06	M18-1.5	10	19	27
0450-06-20	3/8	9.5	06	M20-1.5	12	22	29
0450-06-22	3/8	9.5	06	M22-1.5	14	22	31
0450-06-24	3/8	9.5	06	M24-1.5	16	24	31
0450-08-20	1/2	12.7	08	M20-1.5	12	22	29
0450-08-22	1/2	12.7	08	M22-1.5	14	22	31
0450-08-24	1/2	12.7	08	M24-1.5	16	24	32
0450-08-30	1/2	12.7	08	M30-2	20	30	33
0450-10-30	5/8	15.9	10	M30-2	20	30	34
0450-12-30	3/4	19	12	M30-2	20	30	35
0450-12-36	3/4	19	12	M36-2	25	36	38
0450-16-36	1	25.4	16	M36-2	25	36	39
0450-16-42	1	25.4	16	M42-2	30	46	42
0450-20-42	1.1/4	31.8	20	M42-2	30	46	43
0450-20-52	1.1/4	31.8	20	M52-2	38	55	45
0450-24-52	1.1/2	38.1	24	M52-2	38	55	45

None

0084

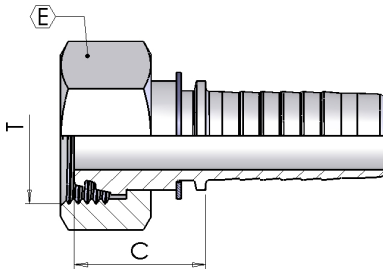

Femmina Metrica cono 24° Serie Pesante

(DKOS)

Product number	hose I.D.		dash size	Dimension			
	in	mm		T	erm.	€	Cut-off C
0084-03-14	3/16	4.8	03	M14-1.5	6	17	22
0084-03-16	3/16	4.8	03	M16-1.5	8	19	25
0084-04-14	1/4	6.4	04	M14-1.5	6	17	23
0084-04-16	1/4	6.4	04	M16-1.5	8	19	25
0084-04-18	1/4	6.4	04	M18-1.5	10	22	24
0084-04-20	1/4	6.4	04	M20-1.5	12	24	22
0084-05-16	5/16	7.9	05	M16-1.5	8	19	26
0084-05-18	5/16	7.9	05	M18-1.5	10	22	25
0084-05-20	5/16	7.9	05	M20-1.5	12	24	25
0084-06-18	3/8	9.5	06	M18-1.5	10	22	25
0084-06-20	3/8	9.5	06	M20-1.5	12	24	25
0084-06-22	3/8	9.5	06	M22-1.5	14	27	29
0084-06-24	3/8	9.5	06	M24-1.5	16	30	29
0084-08-20*	1/2	12.7	08	M20-1.5	12	27	28
0084-08-22	1/2	12.7	08	M22-1.5	14	27	17
0084-08-24	1/2	12.7	08	M24-1.5	16	30	30
0084-08-30	1/2	12.7	08	M30-2	20	36	33
0084-10-24*	5/8	15.9	10	M24-1.5	16	30	31
0084-10-30	5/8	15.9	10	M30-2	20	36	33
0084-12-30	3/4	19	12	M30-2	20	36	34
0084-12-36	3/4	19	12	M36-2	25	46	40
0084-16-36	1	25.4	16	M36-2	25	46	41
0084-16-42	1	25.4	16	M42-2	30	50	43
0084-20-52	1.1/4	31.8	20	M52-2	38	60	44
0084-24-52	1.1/2	38.1	24	M52-2	38	60	44

*Dado Pressato

0184

Curva Metrica 90° cono 24° Serie Pesante

(DKOS-90°)

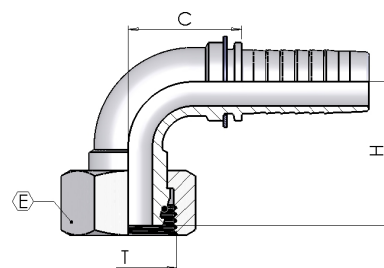

Product number	hose I.D. I.D.		Dimension					
	in	mm	dash size	T	erm.	E	H	Cut-off C
0184-03-16	3/16	4.8	03	M16-1.5	8	19	25	22
0184-04-14	1/4	6.4	04	M14-1.5	6	17	26	27
0184-04-16	1/4	6.4	04	M16-1.5	8	19	26	26
0184-04-18	1/4	6.4	04	M18-1.5	10	22	31	27
0184-04-20	1/4	6.4	04	M20-1.5	12	24	30	27
0184-05-18	5/16	7.9	05	M18-1.5	10	22	33	33
0184-05-20	5/16	7.9	05	M20-1.5	12	24	34	30
0184-06-18	3/8	9.5	06	M18-1.5	10	22	35	34
0184-06-20	3/8	9.5	06	M20-1.5	12	24	34	34
0184-06-22	3/8	9.5	06	M22-1.5	14	27	33	33
0184-06-24	3/8	9.5	06	M24-1.5	16	30	35	33
0184-08-20*	1/2	12.7	08	M20-1.5	12	27	48	40
0184-08-22	1/2	12.7	08	M22-1.5	14	27	41	40
0184-08-24	1/2	12.7	08	M24-1.5	16	30	41	40
0184-10-24*	5/8	15.9	10	M24-1.5	16	30	60	42
0184-10-30	5/8	15.9	10	M30-2	20	36	50	46
0184-12-30	3/4	19	12	M30-2	20	36	56	58
0184-12-36	3/4	19	12	M36-2	25	46	57	59
0184-16-36	1	25.4	16	M36-2	25	46	67	77
0184-16-42	1	25.4	16	M42-2	30	50	67	72
0184-20-52	1.1/4	31.8	20	M52-2	38	60	82	84
0184-24-52	1.1/2	38.1	24	M52-2	38	60	105	105

*Dado Pressato

0284

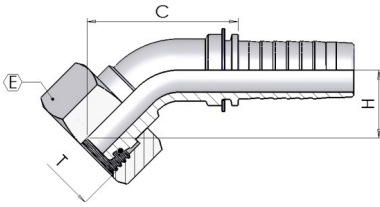

Curva Metrica 45° cono 24° Serie Pesante

(DKOS-45°)

Product number	hose I.D.		I.D.	Dimension				
	in	mm		dash size	T	erm.	E	H
0284-03-16	3/16	4.8	03	M16-1.5	8	19	16	36
0284-04-14	1/4	6.4	04	M14-1.5	6	17	15	37
0284-04-16	1/4	6.4	04	M16-1.5	8	19	15	42
0284-04-18	1/4	6.4	04	M18-1.5	10	22	18	45
0284-05-20	5/16	7.9	05	M20-1.5	12	24	19	49
0284-06-18	3/8	9.5	06	M18-1.5	10	22	19	51
0284-06-20	3/8	9.5	06	M20-1.5	12	24	18	53
0284-06-22	3/8	9.5	06	M22-1.5	14	27	20	54
0284-08-24	1/2	12.7	08	M24-1.5	16	30	21	63
0284-10-30	5/8	15.9	10	M30-2	20	36	29	74
0284-12-30	3/4	19	12	M30-2	20	36	30	87
0284-12-36	3/4	19	12	M36-2	25	46	29	56
0284-16-36	1	25.4	16	M36-2	25	46	30	85
0284-16-42	1	25.4	16	M42-2	30	50	30	85
0284-20-52	1.1/4	31.8	20	M52-2	38	60	39	105
0284-24-52	1.1/2	38.1	24	M52-2	38	60	53	129

None

0550

Femmina Metrica Tubolare Diritta

(BEL-BES)

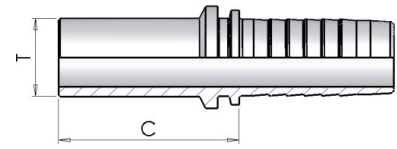

Product number	hose I.D.		Dimension			
	in	mm	dash size	Pipe T	Type	Cut-off C
0550-03-06	3/16	4.8	03	6	L/S	30
0550-03-08	3/16	4.8	03	8	L/S	29
0550-04-06	1/4	6.4	04	6	L/S	32
0550-04-08	1/4	6.4	04	8	L/S	30
0550-04-10	1/4	6.4	04	10	L/S	33
0550-04-12	1/4	6.4	04	12	L/S	30
0550-05-08	5/16	7.9	05	08	L/S	31
0550-05-10	5/16	7.9	05	10	L/S	31
0550-05-12	5/16	7.9	05	12	L/S	33
0550-06-08	3/8	9.5	06	08	L/S	33
0550-06-10	3/8	9.5	06	10	L/S	33
0550-06-12	3/8	9.5	06	12	L/S	32
0550-06-14	3/8	9.5	06	14	S	37
0550-06-15	3/8	9.5	06	15	L	32
0550-08-12	1/2	12.7	08	12	L/S	36
0550-08-14	1/2	12.7	08	14	S	39
0550-08-15	1/2	12.7	08	15	L	34
0550-08-16	1/2	12.7	08	16	S	39
0550-08-18	1/2	12.7	08	18	L	35
0550-08-20	1/2	12.7	08	20	S	45
0550-10-18	5/8	15.9	10	18	L	35
0550-10-20	5/8	15.9	10	20	S	45
0550-10-22	5/8	15.9	10	22	L	33
0550-12-18	3/4	19	12	18	L	37
0550-12-20	3/4	19	12	20	S	46
0550-12-22	3/4	19	12	22	L	38
0550-12-25	3/4	19	12	25	S	49
0550-12-28	3/4	19	12	28	L	40
0550-16-25	1	25.4	16	25	S	51
0550-16-28	1	25.4	16	28	L	41
0550-16-30	1	25.4	16	30	S	54
0550-16-38	1	25.4	16	38	S	60
0550-20-30	1.1/4	31.8	20	30	S	58
0550-20-35	1.1/4	31.8	20	35	L	48
0550-20-38	1.1/4	31.8	20	38	S	62
0550-24-38	1.1/2	38.1	24	38	S	63
0550-24-42	1.1/2	38.1	24	42	L	50

0650

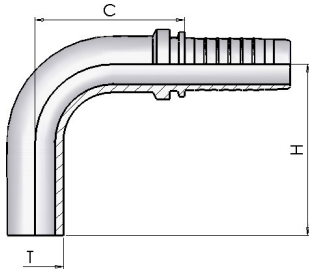

0650S

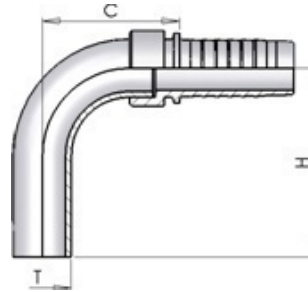

Femmina Metrica Tubolare 90°

(BEL-BES 90°)

Product number	hose I.D.	I.D.	Dimension				
	in	mm	dash size	Pipe T	Type	H	Cut-off C
0650-03-06	3/16	4.8	03	6	L/S	32	20
0650S03-08	3/16	4.8	03	8	L/S	41	25
0650-04-06	1/4	6.4	04	6	L/S	32	23
0650-04-08	1/4	6.4	04	8	L/S	34	25
0650-04-10	1/4	6.4	04	10	L/S	43	25
0650S04-12	1/4	6.4	04	12	L/S	44	35
0650-05-10	5/16	7.9	05	10	L/S	40	29
0650-05-12	5/16	7.9	05	12	L/S	45	29
0650-06-10	3/8	9.5	06	10	L/S	40	27
0650-06-12	3/8	9.5	06	12	L/S	44	30
0650S06-15	3/8	9.5	06	15	L	52	39
0650S08-12	1/2	12.7	08	12	L/S	44	33
0650S08-15	1/2	12.7	08	15	L	52	39
0650S08-18	1/2	12.7	08	18	L	56	42
0650S10-18	5/8	15.9	10	18	L	56	51
0650S12-22	3/4	19	12	22	L	71	51
0650S12-25	3/4	19	12	25	S	75	57
0650S16-25	1	25.4	16	25	S	75	57
0650S16-28	1	25.4	16	28	L	89	60
0650S24-42	1.1/2	38.1	24	42	L	125	106

None

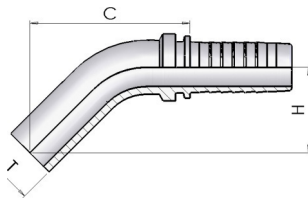
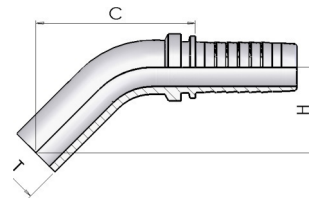
0750**0750S****Femmina Metrica Tubolare 45°****(BEL-BES 45°)**

Product number	hose I.D.		Dimension				
	in	mm	dash size	Pipe T	Type	H	Cut-off C
0750-03-06	3/16	4.8	03	6	L/S	25	38
0750-04-06	1/4	6.4	04	6	L/S	24	41
0750-04-08	1/4	6.4	04	8	L/S	25	43
0750-04-10	1/4	6.4	04	10	L/S	30	47
0750-05-10	5/16	7.9	05	10	L/S	30	49
0750-06-10	3/8	9.5	06	10	L/S	33	50
0750-06-12	3/8	9.5	06	12	L/S	33	52
0750S08-12	1/2	12.7	08	12	L	29	51
0750S08-15	1/2	12.7	08	15	L	29	55
0750S08-18	1/2	12.7	08	18	L	29	56
0750S10-18	5/8	15.7	10	18	L	29	56
0750S12-22	3/4	19	12	22	L	35	65

None

0035

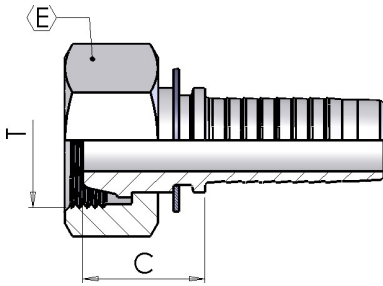

Femmina Metrica Cono 24° Serie Leggera Multiseal

(DKL)

Product number	hose I.D.		Dimension				I.D.	
	in	dash size	mm	T	erm.	E	Cut-off C	
0035-03-12	3/16	03	4.8	M12-1.5	6	14	19	
0035-03-16	3/16	03	4.8	M16-1.5	10	19	18	
0035-04-14	1/4	04	6.4	M14-1.5	8	17	19	
0035-04-16	1/4	04	6.4	M16-1.5	10	19	19	
0035-05-16	5/16	05	7.9	M16-1.5	10	19	19	
0035-05-18	5/16	05	7.9	M18-1.5	12	22	21	
0035-06-16	3/8	06	9.5	M16-1.5	10	19	23	
0035-06-18	3/8	06	9.5	M18-1.5	12	22	23	
0035-06-22	3/8	06	9.5	M22-1.5	15	27	22	
0035-08-22	1/2	08	12.7	M22-1.5	15	27	22	
0035-08-26	1/2	08	12.7	M26-1.5	18	32	24	
0035-10-26	5/8	10	15.9	M26-1.5	18	32	24	
0035-12-30	3/4	12	19	M30-2	22	36	29	
0035-16-36	1	16	25.4	M36-2	28	41	30	

None

0135

Curva Metrica 90° Cono 24° Serie Leggera Multiseal

(DKL-90°)

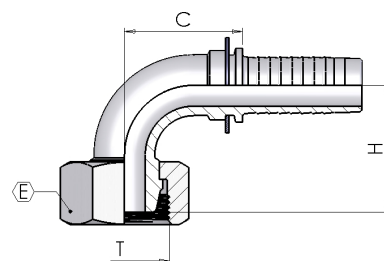

Product number	hose I.D.		Dimension					I.D.
	in	dash size	mm	T	erm.	E	H	Cut-off C
0135-04-14	1/4	04	6.4	M14-1.5	8	17	25	25
0135-04-16	1/4	04	6.4	M16-1.5	10	19	24	26
0135-05-16	5/16	05	7.9	M16-1.5	10	19	29	32
0135-06-18	3/8	06	9.5	M18-1.5	12	22	30	36
0135-08-22	1/2	08	12.7	M22-1.5	15	27	38	41

None

0400

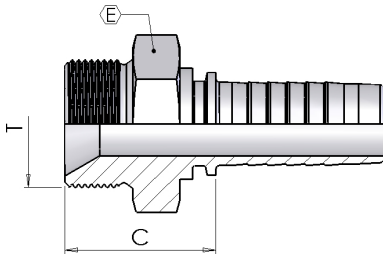

Maschio Metrico Svas.60°

(AGM)

Product number	hose I.D.		I.D.	Dimension		
	in	mm		dash size	T	E
0400-03-10	3/16	4.8	03	M10-1	14	19
0400-03-12	3/16	4.8	03	M12-1.5	17	25
0400-04-14	1/4	6.4	04	M14-1.5	19	26
0400-05-16	5/16	7.9	05	M16-1.5	22	26
0400-05-18	5/16	7.9	05	M18-1.5	24	26
0400-06-14	3/8	9.5	06	M14-1.5	19	26
0400-06-16	3/8	9.5	06	M16-1.5	22	26
0400-06-18	3/8	9.5	06	M18-1.5	24	27
0400-08-18	1/2	12.7	08	M18-1.5	24	28
0400-08-22	1/2	12.7	08	M22-1.5	27	30
0400-10-26	5/8	15.9	10	M26-1.5	32	32
0400-12-30	3/4	19	12	M30-1.5	36	36
0400-16-38	1	25.4	16	M38-1.5	46	37
0400-20-45	1.1/4	31.8	20	M45-1.5	55	39

None

0100

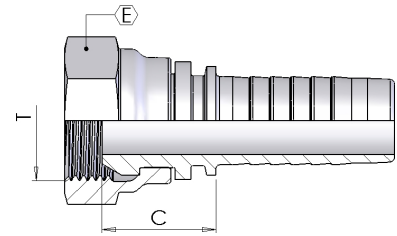
Femmina Metrica Cono 60°**(DKM)**

Product number	hose I.D.		I.D.	Dimension		
	in	mm		dash size	T	E
0100-03-10	3/16	4.8	03	M10-1	14	15
0100-04-10	1/4	6.4	04	M10-1	14	15
0100-04-14	1/4	6.4	04	M14-1.5	19	17
0100-05-14	5/16	7.9	05	M14-1.5	19	17
0100-05-16	5/16	7.9	05	M16-1.5	22	19
0100-05-18	5/16	7.9	05	M18-1.5	24	19
0100-06-14	3/8	9.5	06	M14-1.5	19	17
0100-06-16	3/8	9.5	06	M16-1.5	22	19
0100-06-18	1/2	12.7	08	M18-1.5	24	19
0100-08-18	1/2	12.7	08	M18-1.5	24	20
0100-08-20	1/2	12.7	08	M20-1.5	27	22.5
0100-08-22	1/2	12.7	08	M22-1.5	27	22.5
0100-10-26	5/8	15.9	10	M26-1.5	32	25
0100-12-30	3/4	19	12	M30-1.5	36	26
0100-16-38	1	25.4	16	M38-1.5	46	33
0100-20-45	1.1/4	31.8	20	M45-1.5	50	34
0100-24-52	1.1/2	38	24	M52x1.5	60	35
0100-32-65	2	50.8	32	M65-2	75	31

None

0200

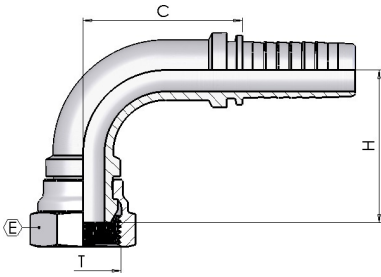

Curva Metrica 90° cono 60°

(DKM-90°)

Product number	hose I.D.		Dimension				I.D.
	in	dash size	mm	T	E	H	Cut-off C
0200-03-10	3/16	03	4.8	M10-1	14	23	22
0200-04-10	1/4	04	6.4	M10-1	14	25	24
0200-04-14	1/4	04	6.4	M14-1.5	19	26	24
0200-05-14	5/16	05	7.9	M14-1.5	19	31	29
0200-05-16	5/16	05	7.9	M16-1.5	22	35	29
0200-05-18	5/16	05	7.9	M18-1.5	24	35	29
0200-06-16	3/8	06	9.5	M16-1.5	22	34	33
0200-06-18	3/8	06	9.5	M18-1.5	24	34	33
0200-08-22	1/2	08	12.7	M22-1.5	27	40	41
0200-12-30	3/4	12	19	M30-1.5	36	36	57
0200-16-38	1	16	25.4	M38-1.5	46	71	70

None

Maschio ORFS

(ORFS)

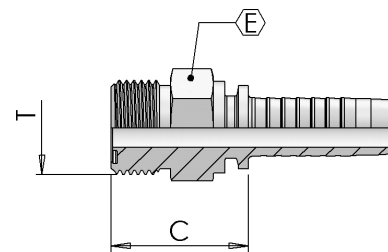

Product number	hose I.D.		Dimension			
	in	mm	dash size	T	E	Cut-off C
S350-04-06-BO	1/4	6.4	04	9/16-18	17	23
S350-04-09-BO	1/4	6.4	04	11/16-16	19	21
S350-05-09-BO	5/16	7.9	05	11/16-16	19	26
S350-06-09-BO	3/8	9.5	06	11/16-16	19	26
S350-06-11-BO	3/8	9.5	6	13/16-16	22	29
S350-08-11-BO	1/2	12.7	08	13/16-16	22	29
S350-08-13-BO	1/2	12.7	08	1-14	27	34
S350-08-14-BO	1/2	12.7	08	1.3/16-12	32	35
S350-10-13-BO	5/8	15.9	10	1-14	27	33
S350-10-14-BO	5/8	15.9	10	1.3/16-12	32	35
S350-12-14-BO	3/4	19	12	1.3/16-12	32	36
S350-12-15-BO	3/4	19	12	1.7/16-12	38	36
S350-16-15-BO	1	25.4	16	1.7/16-12	38	37
S350-16-21-BO	1	25.4	16	1.11/16-12	46	38
S350-20-21-BO	1.1/4	31.8	20	1.11/16-12	46	39

- con tappo ed O-Ring

S050

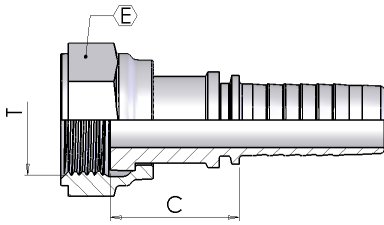

Femmina ORFS

(ORFS)

Product number	hose I.D.		I.D.	Dimension		
	in	mm		dash size	T	E
S050-04-06	1/4	6.4	04	9/16-18	19	25
S050-04-09	1/4	6.4	04	11/16-16	22	29
S050-05-09	5/16	7.9	05	11/16-16	22	29
S050-06-09	3/8	9.5	06	11/16-16	22	29
S050-06-11	3/8	9.5	06	13/16-16	24	30
S050-08-11	1/2	12.7	08	13/16-16	24	32
S050-08-13	1/2	12.7	08	1-14	30	35
S050-08-14	1/2	12.7	08	1.3/16-12	36	37
S050-10-13	5/8	15.9	10	1-14	30	35
S050-10-14	5/8	15.9	10	1.3/16-12	36	34
S050-12-13	3/4	19	12	1-14	30	37
S050-12-14	3/4	19	12	1.3/16-12	36	35
S050-12-15	3/4	19	12	1.7/16-12	41	41
S050-16-15	1	25.4	16	1.7/16-12	41	39
S050-20-21	1.1/4	31.8	20	1.11/16-12	50	40
S050-24-32	1.1/2	38.1	24	2-12	60	41

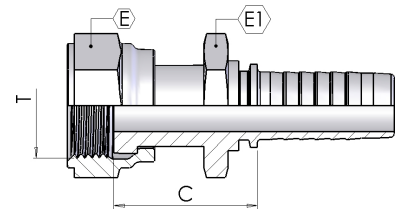
S05T**Femmina ORFS doppio esagono****(ORFS)**

Product number	hose I.D.		Dimension				I.D.
	in	dash size	mm	T	E	E1	Cut-off C
S05T-04-06	1/4	04	6.4	9/16-18	17	15	30
S05T-06-09	3/8	06	9.5	11/16-16	22	17	34
S05T-08-11	1/2	08	12.7	13/16-16	24	19	37
S05T-10-13	5/8	10	15.9	1-14	30	24	41
S05T-12-14	3/4	12	19	1.3/16-12	36	30	42
S05T-16-15	1	16	25.4	1.7/16-12	41	36	50

S150

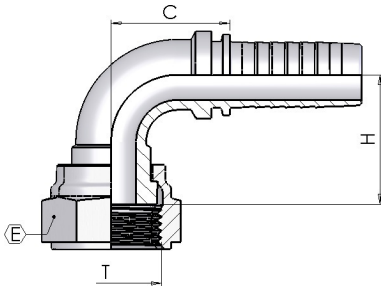

Curva ORFS 90°

(ORFS-90°)

Product number	hose I.D.		Dimension				I.D.
	in	dash size	mm	T	E	H	Cut-off C
S150-04-06	1/4	04	6.4	9/16-18	19	26	25
S150-04-09	1/4	04	6.4	11/16-16	22	23	25
S150-05-09	5/16	05	7.9	11/16-16	22	32	29
S150-06-09	3/8	06	9.5	11/16-16	22	33	33
S150-06-11	3/8	06	9.5	13/16-16	24	32	33
S150-08-11	1/2	08	12.7	13/16-16	24	36	43
S150-08-13	1/2	08	12.7	1-14	30	40	39
S150-08-14	1/2	08	12.7	1.3/16-12	36	39	42
S150-10-13	5/8	10	15.9	1-14	30	42	44
S150-10-14	5/8	10	15.9	1.3/16-12	36	39	42
S150-12-13	3/4	12	19	1-14	30	39	42
S150-12-14	3/4	12	19	1.3/16-12	36	49	57
S150-12-15	3/4	12	19	1.7/16-12	41	51	56
S150-16-15	1	16	25.4	1.7/16-12	41	62	67
S150-16-21	1	20	25.4	1.11/16-12	50	58	62
S150-20-21	1.1/4	20	31.8	1.11/16-12	50	58	63
S150-24-32	1.1/2	24	38.1	2-12	60	73	80

None

S15S

Curva ORFS 90° - ISO SHORT

(ORFS-90°)

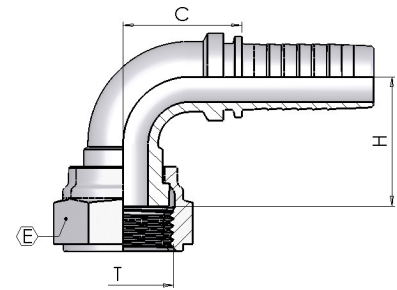

Product number	hose I.D.		Dimension				I.D.
	in	dash size	mm	T	E	H	Cut-off C
S15S-04-06	1/4	04	6.4	9/16-18	19	21	25
S15S-06-09	3/8	06	9.5	11/16-16	22	23	33
S15S-08-11	1/2	08	12.7	13/16-16	24	29	43
S15S-08-13	1/2	08	12.7	1-14	30	32	39
S15S-10-13	5/8	10	15.9	1-14	30	32	47
S15S-12-14	3/4	12	19	1.3/16-12	36	48	57
S15S-16-15	1	16	25.4	1.7/16-12	41	56	67

None

S250

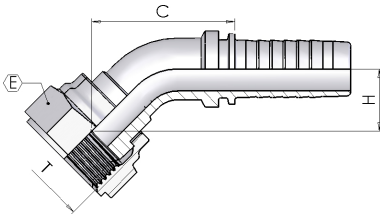

Curva ORFS 45°

(ORFS-45°)

Product number	hose I.D.		Dimension				
	in	mm	dash size	T	E	H	Cut-off C
S250-04-06	1/4	6.4	04	9/16-18	19	14	40
S250-04-09	1/4	6.4	04	11/16-16	22	14	38
S250-05-09	5/16	7.9	05	11/16-16	22	14	44
S250-06-09	3/8	9.5	06	11/16-16	22	17	52
S250-06-11	3/8	9.5	06	13/16-16	24	18	51
S250-08-11	1/2	12.7	08	13/16-16	24	20	62
S250-08-13	1/2	12.7	08	1-14	30	23	64
S250-08-14	1/2	12.7	08	1.3/16-12	36	17	44
S250-10-13	5/8	15.9	10	1-14	30	22	67
S250-10-14	5/8	15.9	10	1.3/16-12	36	18	44
S250-12-13	3/4	19	12	1-14	30	15	40
S250-12-14	3/4	19	12	1.3/16-12	36	23	84
S250-12-15	3/4	19	12	1.7/16-12	41	26	84
S250-16-15	1	25.4	16	1.7/16-12	41	27	101
S250-20-21	1.1/4	31.8	20	1.11/16-12	50	44	125
S250-24-32	1.1/2	38.1	24	2-12	60	29	78

None

1260

Flangia Diritta SAE 3000 PSI

(SFL)

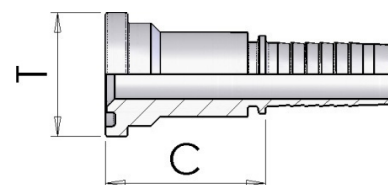

Product number	hose I.D.		Dimension			
	in	mm	dash size	T Flange	mm	Cut-off C
1260-08-08	1/2	12.7	08	1/2	30,2	45
1260-08-12	1/2	12.7	08	3/4	38.1	50
1260-10-08	5/8	15.9	10	1/2	30,2	45
1260-10-10	5/8	15.9	10	5/8	34	56
1260-10-12	5/8	15.9	10	3/4	38.1	49
1260-12-12	3/4	19	12	3/4	38.1	50
1260-12-16	3/4	19	12	1	44.5	53
1260-16-16	1	25.4	16	1	44.5	54
1260-16-20	1	25.4	16	1.1/4	50.8	57
1260-20-20	1.1/4	31.8	20	1.1/4	50.8	59
1260-20-24	1.1/4	31.8	20	1.1/2	60.3	62
1260-24-24	1.1/2	38.1	24	1.1/2	60.3	62
1260-24-32	1.1/2	38.1	24	2	71.4	67
1260-32-32	2	50.8	32	2	71.4	68
1260-32-40	2	50.8	32	2.1/2	84.1	76
1260-40-40	2.1/2	63,5	40	2.1/2	84	76
1260-48-48	3	76,2	48	3	102	63

None

1060

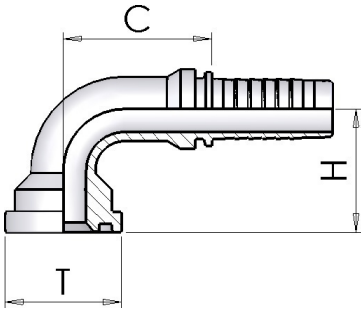

Flangia 90° SAE 3000 PSI

(SFL 90°)

Product number	hose I.D.		Dimension				
	in	dash size	mm	T Flange	mm	drop H	Cut-off C
1060-08-08	1/2	08	12.7	1/2	30,2	39	39
1060-08-12	1/2	08	12.7	3/4	38.1	44	42
1060-10-08	5/8	10	15.9	1/2	30,2	42	45
1060-10-12	5/8	10	15.9	3/4	38.1	47	45
1060-12-12	3/4	12	19	3/4	38.1	53	56
1060-12-16	3/4	12	19	1	44.5	58	56
1060-16-16	1	16	25.4	1	44.5	65	70
1060-16-20	1	16	25.4	1.1/4	50.8	70	67
1060-16-24	1	16	25.4	1.1/2	60.3	71	72
1060-20-16	1.1/4	20	31.8	1	44.5	73	83
1060-20-20	1.1/4	20	31.8	1.1/4	50.8	79	85
1060-20-24	1.1/4	20	31.8	1.1/2	60.3	81	85
1060-24-24	1.1/2	24	38.1	1.1/2	60.3	89	98
1060-24-32	1.1/2	24	38.1	2	71.4	90	102
1060-32-32	2	32	50.8	2	71.4	113	134

None

1160

Flangia 45° SAE 3000 PSI

(SFL 45°)

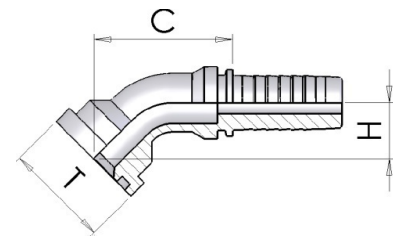

Product number	hose I.D.		Dimension				
	in	mm	dash size	T Flange	mm	H	Cut-off C
1160-08-08	1/2	12.7	08	1/2	30.2	22	62
1160-08-12	1/2	12.7	08	3/4	38.1	25	67
1160-12-12	3/4	19	12	3/4	38.1	25	69
1160-12-16	3/4	19	12	1	44.5	30	88
1160-16-16	1	25.4	16	1	44.5	29	82
1160-20-20	1.1/4	31.8	20	1.1/4	50.8	38	102
1160-20-24	1.1/4	31.8	20	1.1/2	60.3	39	106
1160-24-24	1.1/2	38.1	24	1.1/2	60.3	44	114
1160-24-32	1.1/2	38.1	24	2	71.4	40	115
1160-32-32	2	50.8	32	2	71.4	58	135

None

FS3L

Flangia 90° SAE 3000 PSI - Tipo Lungo

(SFL 90° L)

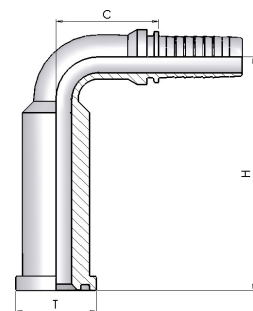

Product number	hose I.D.		Dimension				
	in	dash size	mm	T Flange	mm	drop H	Cut-off C
FS3L-12-12	3/4	12	19	3/8	38.1	123	56
FS3L-16-16	1	16	25.4	1	44.5	127	70
FS3L-20-20	1.1/4	20	31.8	1.1/4	50.8	178	85

None

S003

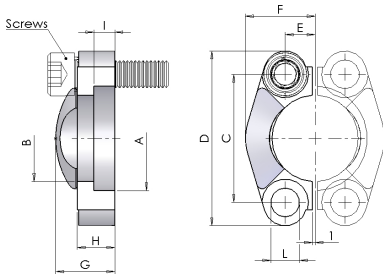

Semiflange tagliate - 3000 psi

Product number	SAE	Dimension									
	size	A	B	C	D	E	F	G	H	I	L
S003-08	1/2"	30.96	24.3	38.1	54	8.7	22.8	19	13	6.2	8.8
S003-12	3/4"	38.89	32.1	47.6	65	11.1	25.9	22	14	6.2	10.8
S003-16	1"	45.24	38.5	52.4	70	13.1	29.2	24	16	7.5	10.8
S003-20	1.1/4"	51.59	43.7	58.7	79	15.1	36.3	22	14	7.5	12
S003-24	1.1/2"	61.09	50.8	69.9	94	17.9	41.1	25	16	7.5	13.5
S003-32	2"	72.24	62.7	77.8	102	21.4	48.2	26	16	9	13.5
S003-40	2.1/2"	84.94	74.9	88.9	114	25.4	54.1	38	19	9	13.5

Questo prodotto è venduto a coppie.

1310

Flangia Diritta SAE 6000 PSI

(SFS)

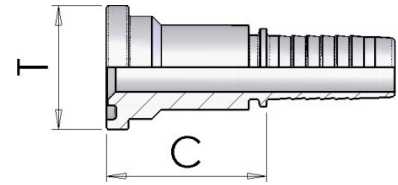

Product number	hose I.D.		Dimension			
	in	mm	dash size	T Flange	mm	Cut-off C
1310-08-08	1/2	12.7	08	1/2	31,8	46
1310-08-12	1/2	12.7	08	3/4	41.3	53
1310-10-08	5/8	15.9	10	1/2	31,8	46
1310-10-12	5/8	15.9	10	3/4	41.3	53
1310-12-12	3/4	19	12	3/4	41.3	54
1310-12-16	3/4	19	12	1	47.6	60
1310-16-12	1	25.4	16	3/4	41.3	55
1310-16-16	1	25.4	16	1	47.6	61
1310-16-20	1	25.4	16	1.1/4	54	68
1310-20-20	1.1/4	31.8	20	1.1/4	54	70
1310-20-24	1.1/4	31.8	20	1.1/2	63.5	76
1310-24-24	1.1/2	38.1	24	1.1/2	63.5	76
1310-24-32	1.1/2	38.1	24	2	79.4	85
1310-32-32	2	50.8	32	2	79.4	85

None

1110

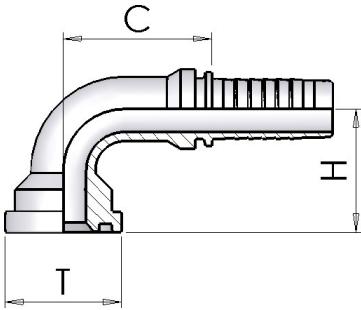

Flangia 90° SAE 6000 PSI

(SFS 90°)

Product number	hose I.D.		Dimension				
	in	mm	dash size	T Flange	mm	drop H	Cut-off C
1110-08-08	1/2	12.7	08	1/2	31.8	39	39
1110-08-12	1/2	12.7	08	3/4	41.3	48	39
1110-10-08	5/8	15.9	10	1/2	31.8	42	45
1110-10-12	5/8	15.9	10	3/4	41.3	52	44
1110-12-12	3/4	19	12	3/4	41.3	55	56
1110-12-16	3/4	19	12	1	47.6	63	56
1110-16-12	1	25.4	16	3/4	41.3	64	68
1110-16-16	1	25.4	16	1	47.6	69	70
1110-16-20	1	25.4	16	1.1/4	54	74	71
1110-20-20	1.1/4	31.8	20	1.1/4	54	83	97
1110-20-24	1.1/4	31.8	20	1.1/2	63.5	93	97
1110-24-24	1.1/2	38.1	24	1.1/2	63.5	103	100
1110-32-32	2	50.8	32	2	79.4	136	125

None

1210

Flangia 45° SAE 6000 PSI

(SFS 45°)

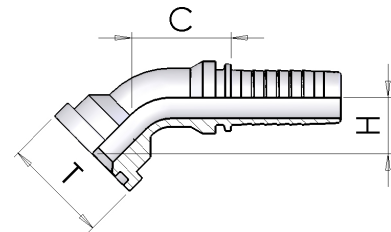

Product number	hose I.D.		Dimension				
	in	mm	dash size	T Flange	mm	drop H	Cut-off C
1210-08-08	1/2	12.7	08	1/2	31.8	22	62
1210-08-12	1/2	12.7	08	3/4	41.3	28	69
1210-10-08	5/8	15.9	10	1/2	31.8	21	66
1210-10-12	5/8	15.9	10	3/4	41.3	27	75
1210-12-12	3/4	19	12	3/4	41.3	28	74
1210-12-16	3/4	19	12	1	47.6	32	90
1210-16-12	1	25.4	16	3/4	41.3	29	94
1210-16-16	1	25.4	16	1	47.6	34	86
1210-16-20	1	25.4	16	1.1/4	54	37	90
1210-20-20	1.1/4	31.8	20	1.1/4	54	41	111
1210-20-24	1.1/4	31.8	20	1.1/2	63.5	48	118
1210-24-24	1.1/2	38.1	24	1.1/2	63.5	50	122
1210-32-32	2	50.8	32	2	79.4	58	151

None

FS6L

Flangia 90° SAE 6000 PSI - Tipo Lungo

(SFS 90° L)

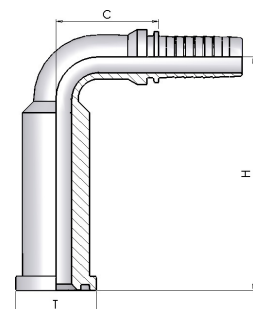

Product number	hose I.D.		Dimension				
	in	mm	dash size	T Flange	mm	drop H	Cut-off C
FS6L-08-08	1/2	12.7	08	1/2	32	75	40
FS6L-12-12	3/4	19	12	3/4	41.3	126	56
FS6L-16-16	1	25.4	16	1	47.6	132	70
FS6L-20-20	1.1/4	31.8	20	1.1/4	54	185	82

None

S006

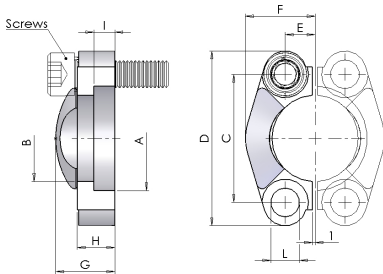

Semiflange tagliate - 6000 psi

Product number	SAE size	Dimension									
		A	B	C	D	E	F	G	H	I	L
S006-08	1/2"	32.54	24.6	40.5	56	9.1	23.6	22	16	7.2	8.8
S006-12	3/4"	42.06	32.5	50.8	71	11.9	30	28	19	8.3	11
S006-16	1"	48.41	38.9	57.2	81	13.9	34.8	33	24	9	13
S006-20	1 1/4"	54.76	44.5	66.7	95	15.9	38.6	38	27	9.8	15
S006-24	1 1/2"	64.29	51.6	79.4	113	18.3	47.5	43	30	12.1	17
S006-32	2"	80.16	67.6	96.8	133	22.2	56.9	52	37	12.1	21

Questo prodotto è venduto a coppie.

130S

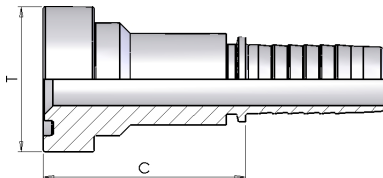

Flangia Diritta SUPERCAT

(SFC)

Product number	hose I.D.		I.D.	dash size	Dimension		
	in	mm			T Flange	mm	Cut-off C
130S-12-12	3/4	19	12	3/4	41.3	58	
130S-12-16	3/4	19	12	1	47.6	64	
130S-16-16	1	25.4	16	1	47.6	65	
130S-16-20	1	25.4	16	1 1/4	54	73	
130S-20-20	1 1/4	31.8	20	1 1/4	54	74	
130S-24-24	1 1/2	38.1	24	1 1/2	63.5	80	

None

110S

Flangia 90° SUPERCAT

(SFC 90°)

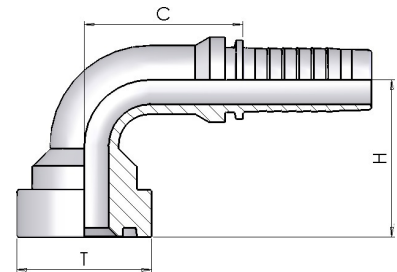

Product number	hose I.D.		Dimension				
	in	mm	dash size	T Flange	mm	H	Cut-off C
110S-12-12	3/4	19	12	3/4	41.3	62	56
110S-12-16	3/4	19	12	1	47.6	65	56
110S-16-16	1	25.4	16	1	47.6	74	78
110S-16-20	1	25.4	16	1.1/4	54	80	78
110S-20-20	1.1/4	31.8	20	1.1/4	54	90	97
110S-20-24	1.1/4	31.8	20	1.1/2	63.5	95	96
110S-24-24	1.1/2	38.1	24	1.1/2	63.5	104	115

120S

Flangia 45° SUPERCAT

(SFC 45°)

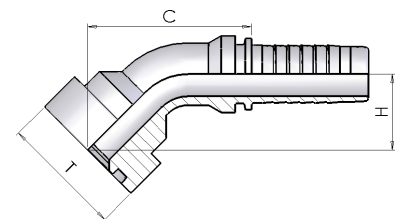

Product number	hose I.D.		Dimension				
	in	mm	dash size	T Flange	mm	H	Cut-off C
120S-12-12	3/4	19	12	3/4	41.3	32	88
120S-12-16	3/4	19	12	1	47.6	37	93
120S-16-16	1	25.4	16	1	47.6	37	90
120S-16-20	1	25.4	16	1.1/4	54	44	122
120S-20-20	1.1/4	31.8	20	1.1/4	54	43	114
120S-20-24	1.1/4	31.8	20	1.1/2	63.5	48	119
120S-24-24	1.1/2	38.1	24	1.1/2	63.5	52	172

None

1250

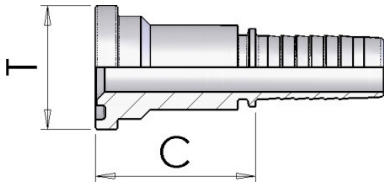

Flangia Komatsu dritta

(JIS-KF)

Product number	hose I.D.		Dimension			
	in	mm	dash size	T Flange	mm	Cut-off C
1250-10-10	5/8	15.9	10	5/8	34	56

1050

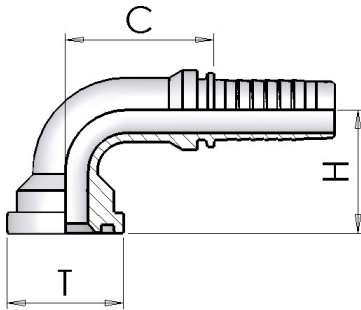

Flangia Komatsu 90°

(JIS-KF)

Product number	hose I.D.		Dimension				
	in	dash size	mm	T Flange	mm	drop H	Cut-off C
1050-10-10	5/8	10	15.9	5/8	34	47	58

1150

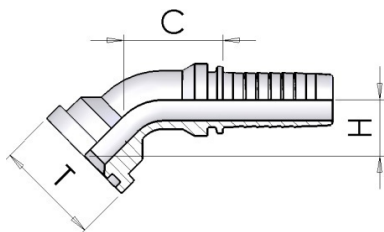

Flangia Komatsu 45°

(JIS-KF)

Product number	hose I.D.		Dimension				
	in	dash size	mm	T Flange	mm	drop H	Cut-off C
1150-10-10	5/8	10	15.9	5/8	34	54	23

0940

Femmina JIS Cono 60° (Komatsu)

(JIS-K)

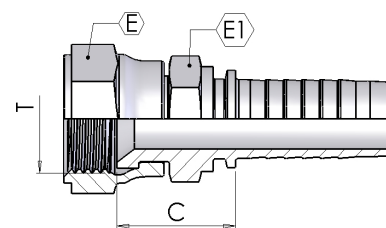

Product number	hose I.D.		dash size	Dimension			
	in	mm		T	E	E1	Cut-off C
0940-04-14	1/4	6.4	04	M14x1,5	19	17	22
0940-05-16	5/16	7.9	05	M16x1,5	22	17	22
0940-06-14	3/8	9.5	06	M14x1,5	19	17	22
0940-06-16	3/8	9.5	06	M16x1,5	22	19	22
0940-06-18	3/8	9.5	06	M18x1,5	24	19	21
0940-08-22	1/2	12.7	08	M22x1,5	27	22	27
0940-08-24	1/2	12.7	08	M24x1,5	30	27	25
0940-10-24	5/8	15.9	10	M24x1,5	30	27	26
0940-12-30	3/4	19	12	M30x1,5	36	30	30
0940-16-33	1	25.4	16	M33x1,5	41	36	33
0940-20-36	1.1/4	31.8	20	M36x1,5	46	46	37
0940-24-42	1.1/2	38.1	24	M42x1,5	50	50	38

None

0990S

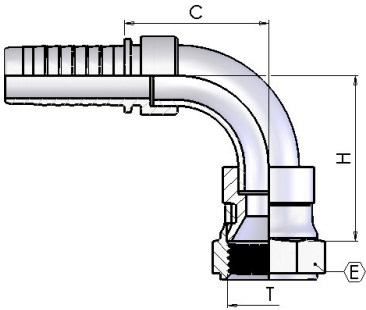

**Curva 90° JIS Cono 60° (Komatsu) -
saldato**

(JIS-K 90°)

Product number	hose I.D.		dash size	Dimension			
	in	mm		T	E	H	Cut-off C
0990S04-14	1/4	6.4	04	M14x1,5	19	35	38
0990S05-16	5/16	7.9	05	M16x1,5	22	30	27
0990S06-14	3/8	9.5	06	M14x1,5	19	33	31
0990S06-18	3/8	9.5	06	M18x1,5	24	33	31
0990S08-22	1/2	12.7	08	M22x1,5	27	39	33
0990S10-24	5/8	15.9	10	M24x1,5	30	48	42
0990S12-30	3/4	19	12	M30x1,5	36	43	48
0990S16-33	1	25.4	16	M33x1,5	41	62	57

0930

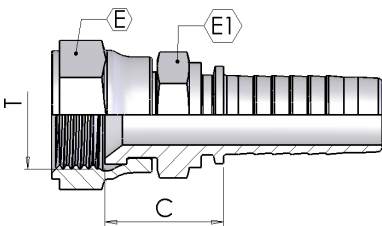

Femmina JIS cono 60° (Toyota)

(JIS-T)

Product number	hose I.D.		dash size	Dimension			
	in	mm		T	E	E1	Cut-off C
0930-04-04	1/4	6.4	04	1/4-19	19	17	20
0930-06-06	3/8	9.5	06	3/8-19	22	19	22
0930-08-08	1/2	12.7	08	1/2-14	27	22	26
0930-12-12	3/4	19	12	3/4-14	32	30	29
0930-16-16	1	25.4	16	1-11	38	36	31
0930-20-20	1,1/4	31.8	20	1,1/4-11	50	46	35
0930-24-24	1,1/2	38.1	24	1,1/2-11	55	50	28

0980S

Curva JIS 90° (Toyota) - saldata

(JIS-T 90°)

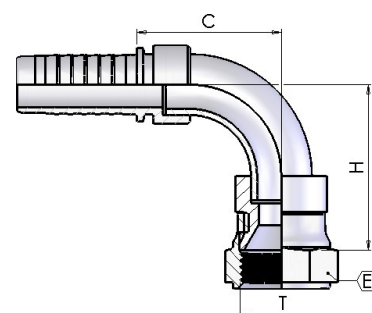

Product number	hose I.D.		I.D.	Dimension				Cut-off C
	in	mm		dash size	T	E	H	
0980S04-04	1/4	6.4	04	1/4-19	19	35	38	
0980S06-06	3/8	9.5	06	3/8-19	22	30	27	
0980S08-08	1/2	12.7	08	1/2-14	27	39	33	
0980S12-12	3/4	19	12	3/4-14	32	55	48	
0980S16-16	1	25.4	16	1-11	38	62	57	

None

0920

Femmina JIS cono 60° (Nissan)

(JIS-N)

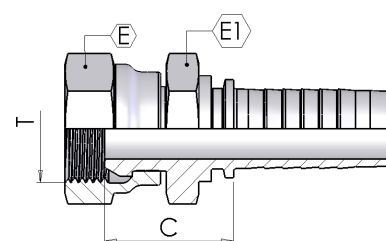

Product number	hose I.D.		I.D.	Dimension				Cut-off C
	in	mm		dash size	T	E	E1	
0920-04-04	1/4	6.4	04	1/4-19	19	19	23	
0920-06-06	3/8	9.5	06	3/8-19	22	22	28	
0920-08-08	1/2	12.7	08	1/2-14	27	27	27	

None

0030

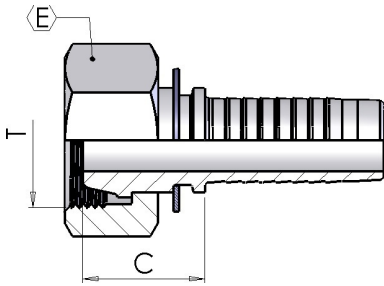

Femmina Metrica Cono 24° Serie Francese

(DKF)

Product number	hose I.D.		Dimension			
	in	I.D. mm	dash size	T	E	Cut-off C
0030-05-20	5/16	7.9	05	M20-1.5	24	25
0030-06-20	3/8	9.5	06	M20-1.5	24	26
0030-08-24	1/2	12.7	08	M24-1.5	30	28
0030-10-30	5/8	15.9	10	M30-1.5	36	25
0030-12-30	3/4	19	12	M30-1.5	36	26
0030-12-36	3/4	19	12	M36-1.5	46	29
0030-16-45	1	25.4	16	M45-1.5	55	30
0030-20-52	1.1/4	31.8	20	M52-1.5	65	34

FK50

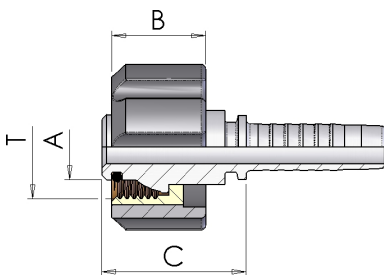

Femmina Tipo 'K' per Idropulitrici

Product number	hose I.D.		Dimension				I.D. Cut-off C
	in	dash size	mm	T	A	B	
FK50-04-22	1/4	04	6.4	M22-1.5	14	20	31
FK50-05-22	5/16	05	7.9	M22-1.5	14	20	31
FK50-06-22	3/8	06	9.5	M22-1.5	14	20	31
FK50-04022	1/4	04	6.4	M22-1.5	14	27	31
FK50-05022	5/16	05	7.9	M22-1.5	14	27	31
FK50-06022	3/8	06	9.5	M22-1.5	14	27	31

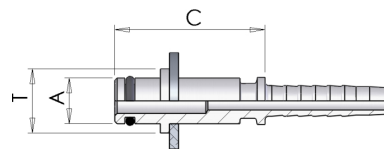
FN50**Inserti Tipo 'K' (per lancia) -
Diametro 10**

Product number	hose I.D.		Dimension		
	in	mm	dash size	A	C
FN50-04-22	1/4	6.4	04	10	33
FN50-05-22	5/16	7.9	05	10	33
FN50-06-22	3/8	9.5	06	10	33

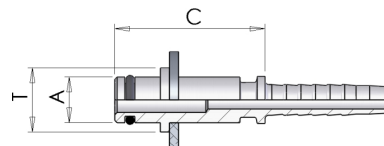
FN51**Inserti Tipo 'K' (per lancia) -
Diametro 11**

Product number	hose I.D.		Dimension		
	in	mm	dash size	A	C
FN51-04-22	1/4	6.4	04	11	33
FN51-05-22	5/16	7.9	05	11	33

None

1400

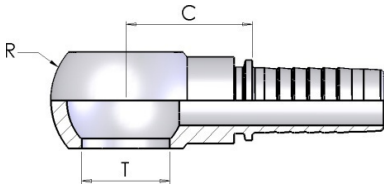

Occhio a Pressare BSP

Product number	hose I.D.		Dimension				
	in	mm	dash size	hole T	mm	R	Cut-off C
1400-03-02	3/16	4.8	03	1/8-28	10.2	17	19
1400-03-04	3/16	4.8	03	1/4-19	13.3	24	26
1400-04-02	1/4	6.4	04	1/8-28	10.2	17	25
1400-04-04	1/4	6.4	04	1/4-19	13.3	24	26
1400-04-06	1/4	6.4	04	3/8-19	17	28	26
1400-05-04	5/16	7.9	05	1/4-19	13.3	24	26
1400-05-06	5/16	7.9	05	3/8-19	17	28	26
1400-06-04	3/8	9.5	06	1/4-19	13.3	24	26
1400-06-06	3/8	9.5	06	3/8-19	17	28	26
1400-06-08	3/8	9.5	06	1/2-14	21.2	36	31
1400-08-06	1/2	12.7	08	3/8-19	17	28	27
1400-08-08	1/2	12.7	08	1/2-14	21.2	36	31
1400-08-12	1/2	12.7	08	3/4-14	26.5	45	38
1400-10-12	5/8	15.9	10	3/4-14	26.5	45	38
1400-12-12	3/4	19	12	3/4-14	26.5	45	38
1400-12-16	3/4	19	12	1-11	33.5	58	49
1400-16-16	1	25.4	16	1-11	33.5	58	50

None

1600

Bullone forato Gas Doppio

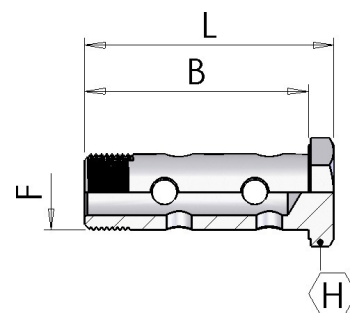

Product number	Dimension			
	F	B	L	H
1600-04-04	1/4-19	43	49	19
1600-06-06	3/8-19	49	57	22
1600-08-08	1/2-14	62	70	27
1600-12-12	3/4-14	78	87	32
1600-16-16	1-11	98	109	41

1600-00

Bullone forato Gas

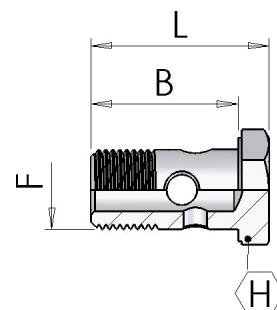

Product number	Dimension			
	F	B	L	H
1600-00-02	1/8-28	19	24	14
1600-00-04	1/4-19	29	34	19
1600-00-06	3/8-19	33	41	22
1600-00-08	1/2-14	38	46	27
1600-00-12	3/4-14	47	56	32
1600-00-16	1-11	58	69	41

None

1350

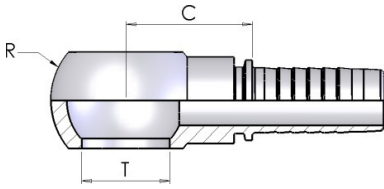

Occhio a Pressare Metrico

Product number	hose I.D.		Dimension				
	in	mm	dash size	hole T	mm	R	Cut-off C
1350-03-10	3/16	4.8	03	M10-1	10.2	17	25
1350-03-12	3/16	4.8	03	M12-1.5	12.2	20	22
1350-04-10	1/4	6.4	04	M10-1	10.2	17	25
1350-04-12	1/4	6.4	04	M12-1.5	12.2	20	22
1350-04-14	1/4	6.4	04	M14-1.5	14.2	24	26
1350-05-14	5/16	7.9	05	M14-1.5	14.2	24	26
1350-05-16	5/16	7.9	05	M16-1.5	16.2	28	26
1350-05-18	5/16	7.9	05	M18-1.5	18.2	32	29
1350-06-14	3/8	9.5	06	M14-1.5	14.2	24	26
1350-06-16	3/8	9.5	06	M16-1.5	16.2	28	26
1350-06-18	3/8	9.5	06	M18-1.5	18.2	32	29
1350-06-22	3/8	9.5	06	M22-1.5	22.2	36	31
1350-08-16	1/2	12.7	08	M16-1.5	16.2	28	27
1350-08-18	1/2	12.7	08	M18-1.5	18.2	32	29
1350-08-22	1/2	12.7	08	M22-1.5	22.2	36	31
1350-10-22	5/8	15.9	10	M22-1.5	22.2	36	31
1350-10-26	5/8	15.9	10	M26-1.5	26.5	45	38
1350-12-22	3/4	19	12	M22-1.5	22.2	36	32
1350-12-26	3/4	19	12	M26-1.5	26.2	46	38
1350-16-30	1	25.4	16	M30-2	30.2	54	45

None

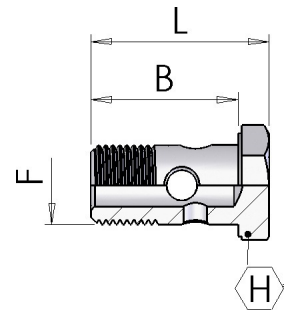
1650**Bullone forato Metrico**

Product number	Dimension			
	F	B	L	H
1650-00-10	M10-1	19	24	14
1650-00-12	M12-1.5	26	31	17
1650-00-14	M14-1.5	29	34	19
1650-00-16	M16-1.5	33	41	22
1650-00-18	M18-1.5	37	44	24
1650-00-22	M22-1.5	38	46	27
1650-00-26	M26-1.5	47	56	32
1650-00-30	M30-1.5	58	68	36

None

D050

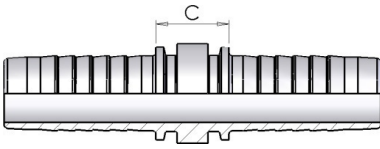

Giunzione per Tubi Flessibili

Product number	hose I.D.		I.D.		Dimension	
	in	mm	dash size	Cut-off C		
D050-03	3/16	4.8	03	17		
D050-04	1/4	6.4	04	22		
D050-05	5/16	7.9	05	22		
D050-06	3/8	9.5	06	22		
D050-08	1/2	12.7	08	23		
D050-10	5/8	15.9	10	18		
D050-12	3/4	19	12	19		
D050-16	1	25.4	16	21		
D050-20	1.1/4	31.8	20	24		
D050-24	1.1/2	38.1	24	24		
D050-32	2	50.8	32	26		

None

Gambo a Saldare

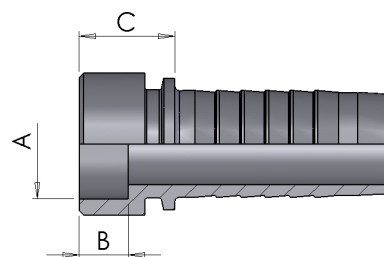

Product number	hose I.D.	I.D.	Dimension			
	in	mm	dash size	A	B	Cut-off C
GS00-03-08	3/16	4,8	03	08	6	12
GS00-04-06	1/4	6.4	04	06	6	14
GS00-04-08	1/4	6.4	04	08	6	14
GS00-04-10	1/4	6.4	04	10	6	15
GS00-04-12	1/4	6.4	04	12	7	17
GS00-05-08	5/16	7,9	05	08	6	14
GS00-05-10	5/16	7,9	05	10	6	14
GS00-05-12	5/16	7,9	05	12	6	14
GS00-06-06	3/8	9.5	06	06	6	15
GS00-06-08	3/8	9.5	06	08	6	15
GS00-06-10	3/8	9.5	06	10	6	14
GS00-06-12	3/8	9.5	06	12	7	15
GS00-06-15	3/8	9.5	06	15	7	14
GS00-08-12	1/2	12.7	08	12	7	15
GS00-08-14	1/2	12.7	08	14	8	15
GS00-08-15	1/2	12.7	08	15	7	15
GS00-08-16	1/2	12.7	08	16	7	15
GS00-08-20	1/2	12.7	08	20	9	18
GS00-10-16	5/8	15.9	10	16	8	16
GS00-10-18	5/8	15.9	10	18	8	16
GS00-10-20	5/8	15.9	10	20	9	18
GS00-12-16	3/4	19	12	16	8	16
GS00-12-18	3/4	19	12	18	8	16
GS00-12-20	3/4	19	12	20	9	18
GS00-12-22	3/4	19	12	22	9	18
GS00-12-25	3/4	19	12	25	9	19
GS00-16-25	1	25.4	16	25	9	19
GS00-16-30	1	25.4	16	30	9	20
GS00-20-35	1.1/4	31.8	20	35	11	23

Non zincato