











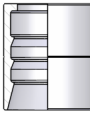





Standard
tail

in!

Braided Trecciato	001C	0022	0001	0002
				
	Swaged Ferrule (no skive)	Swaged Ferrule (no skive)	Swaged Ferrule (skive)	Swaged Ferrule (skive)
	9	9	10	10
Compact Compatto	003T	Textile Tessile	0003	Thermo plastic
				
	Swaged Ferrule (no skive)		Swaged Ferrule (no skive)	
	11		11	
0007	0008	PTFE	PTFE	PTFE-C
				
Swaged Ferrule (no skive)	Swaged Ferrule (no skive)		Ferrule for PTFE hose	Ferrule for PTFE hose
12	12		13	13
Spiral	0009	004H	BMC1	BMC2
				
	Swaged Ferrule (skive)	Swaged Ferrule (skive)	Swaged Ferrule (no skive)	Swaged Ferrule (no skive)
	14	14	15	15
BSP Flat	0345	0060	MALE BSP 60°	0350
				
	BSP Male - Flat Seat	BSP Female Flat Seal		BSP Male Parallel 60° cone
	16	17		18

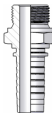
035G

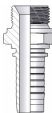

BSP Male Parallel 60°
Cone - Rotating

19



0051



BSP Female 60° Cone
Rolled Nut

20

0050



BSP Female 60° cone
Thrust Wire

21

0052



BSP Female 60° Cone
Slip On Nut

22

0041



BSP O'Ring Female
60° Cone- Rolled Nut

22

0040

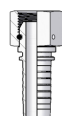

BSP O'Ring Female
60° Cone-Thrust wire

23

0042

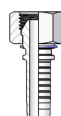

BSP O'Ring Female
60° Cone - Slip on nut

23

0151



BSP 90° Swept elbow
60° cone Rolled Nut

24

0150



BSP 90° Swept Elbow
60° cone Thrust Wire

25

0152



BSP 90° Swept elbow
60° cone Slip On Nut

26

0141

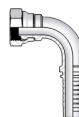

BSP O'Ring 90° Swept
elbow 60° cone- Rol-
led Nut

26

0140



BSP O'Ring 90° Swept
elbow 60° cone-
Thrust Wire Nut

27

0142



BSP O'Ring 90° Swept
elbow 60° cone- Slip
on nut

27

2300

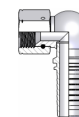

BSP 90° Compact El-
bow 60° Cone - Thrust
wire - Welded

28

2301

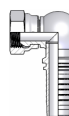

BSP 90° Compact El-
bow 60° Cone - Rolled
nut - Welded

28

2320

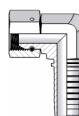

BSP 90° Compact El-
bow 60° Cone - Thrust
wire

29

2321

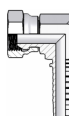

BSP 90° Compact El-
bow 60° Cone - Rolled
nut

29

0251



BSP 45° Swept Elbow
60° Cone - Rolled nut

30

0250



BSP 45° Swept Elbow
60° Cone - Thrust
Wire Nut

31

0252

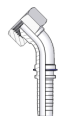

BSP 45° Swept Elbow
60° Cone - Slip on
nut

32

0241



BSP O'Ring 45° Swept
Elbow 60° Cone - Rol-
led nut

32

0240



BSP O'Ring 45° Swept
Elbow 60° Cone -
Thrust Wire Nut

33

0242



BSP O'Ring 45° Swept
Elbow 60° Cone - Slip
on nut

33



0360

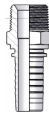

BSP Taper Male 60° cone

34

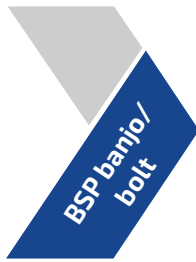

1400



BSP Banjo

35

1600



Double BSP perfored bolt

36

1600-00



BSP perfored bolt

36



0370

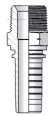

NPTF Male 60° cone

37

037G

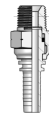

NPTF Male Parallel 60° Cone - Rotating

38

N051



NPSM Female 60° Cone Rolled Nut

38



0850



JIC Male 74° cone

39



0901



JIC Female 74° cone - Rolled Nut

40

0900

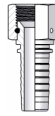

JIC Female 74° Thrust Wire Nut

41

0902

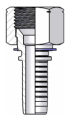

JIC Female 74° - Slip on nut

42

0901D



JIC Female 74° cone - Double hexagon

42

0951



JIC 90° Swept Elbow 74° cone - Rolled Nut

43

0950



JIC 90° Swept Elbow 74° cone - Thrust Wire Nut

44

0952

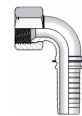

JIC 90° Swept Elbow 74° cone - Slip on nut

45

2970

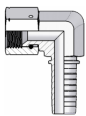

JIC 90° Compact Elbow 74° cone - Thrust Wire Nut

45

2971

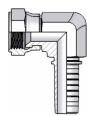

JIC 90° Compact Elbow 74° cone - Crimped Nut

46

2950

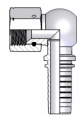

JIC 90° Compact Elbow 74° cone - Thrust Wire Nut - Welded

46

2951

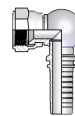

JIC 90° Compact Elbow 74° cone - Rolled Nut - Welded

47

1001



JIC 90° Swept Elbow 74° cone - Rolled Nut

47

1002



JIC 45° Swept Elbow
74° Cone Slip on nut

48



0385

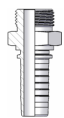

SAE Male O'R Flat
Seat

48

0390

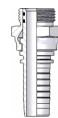

Swivel Male O'Ring

49

0395

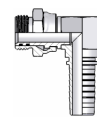

90° Swivel Male O'ring

49



IF00



Straight Male Inverted
Flare Swivel

50

IF90



90° Male Inverted
Flare Swivel

50

IF45

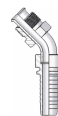

45° Male Inverted
Flare Swivel

51



0400

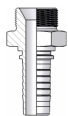

Metric Male 60° cone

51

0100



Metric Female 60°
cone

52

0200



90° Metric Swept
Elbow 60° cone

52

0300



45° Metric Swept
Elbow 60° cone

53



0035

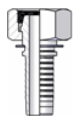

Metric Female 24°
Seat Light Multiseal

53

0135

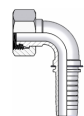

90° Metric Swept
Elbow 24° Seat Light
Multiseal

54

0235



45° Metric Swept
Elbow 24° Seat Light
Multiseal

54



0500

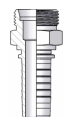

Metric Male 24° Seat
Light

55



0085



Metric Female 24°
Seat Light

56

0085R



Metric Female 24°
Seat Light (rolled nut)

56

0185



90° Metric Swept
Elbow 24° Seat Light

57

0185R



90° Metric Swept Elbow 24° Seat Light (rolled nut)

58

0285



45° Metric Swept Elbow 24° Seat Light

58

0285R



45° Metric Swept Elbow 24° Seat Light (rolled nut)

59



0450



Metric Male 24° Seat Heavy

59



0084



Metric Female 24° Seat Heavy

60

0184



90° Metric Swept Elbow 24° Seat Heavy

61

0284



45° Metric Swept Elbow 24° Seat Heavy

62



1350



Metric Banjo

63

1650



Metric perfored bolt

63

0550



Metric Standpipe

64

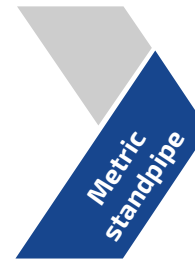

0650



90° Metric Standpipe

65

0650S



90° Metric Standpipe (welded)

66

0750



45° Metric Standpipe

67

0750S



45° Metric Standpipe (Welded)

67



0030

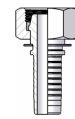

Metric Female 24° Cone French Type

68

0130



90° Metric Swept Elbow 24° Cone French Type

68



FK50

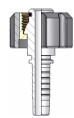

K' Female

69

FN50



'K' Male (for gun) - Diameter 10

69

FN51



'K' Male (for gun) - Diameter 11

70

 <p>Steko Male</p>	<p>0398</p>  <p>Staplelock Male</p> <p>70</p>	 <p>Kobelco Male</p>	<p>K05B</p>  <p>Kobelko Male</p> <p>71</p>	 <p>ORFS Male</p>
<p>S350</p>  <p>ORFS Male</p> <p>71</p>	 <p>ORFS crimped nut</p>	<p>S050</p>  <p>ORFS Female</p> <p>72</p>	<p>S05T</p>  <p>ORFS Female Back Hexagon</p> <p>72</p>	<p>S150</p>  <p>ORFS 90° Swept Elbow</p> <p>73</p>
<p>S250</p>  <p>ORFS 45° Swept Elbow</p> <p>74</p>	 <p>JIS Nissan</p>	<p>0920</p>  <p>JIS Female 60° cone (Nissan)</p> <p>74</p>	 <p>JIS Toyota</p>	<p>0930</p>  <p>JIS Female 60° cone (Toyota)</p> <p>75</p>
<p>0980S</p>  <p>90° JIS Swept Elbow (Toyota) - welded</p> <p>75</p>	<p>1030S</p>  <p>45° JIS Swept Elbow (Toyota) - welded</p> <p>76</p>	 <p>JIS Komatsu</p>	<p>0940</p>  <p>JIS Female 60° Cone (Komatsu)</p> <p>76</p>	<p>0990S</p>  <p>90° JIS Swept Elbow (Komatsu) - welded</p> <p>77</p>
<p>1040S</p>  <p>45° JIS Swept Elbow (Komatsu) - welded</p> <p>77</p>	<p>1050</p>  <p>Komatsu Flange 90°</p> <p>78</p>	<p>1150</p>  <p>Komatsu Flange 45°</p> <p>78</p>	<p>1250</p>  <p>Komatsu Flange - Straight</p> <p>78</p>	 <p>SAE 3000</p>

1260



Straight SAE Flange
3000 PSI

79

1060

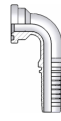

90° SAE Flange 3000
PSI

80

1160



45° SAE Flange 3000
PSI

80

1060



22.5°/30°/60°/67.5°
SAE Flange 3000 PSI

81



FS3L

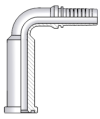

90° SAE Flange 3000
Psi - Long Drop

82

S003



Cut Split Flanges -
3000 psi

82



1310



Straight SAE Flange
6000 PSI

83

1110



90° SAE Flange 6000
PSI

84

1210



45° SAE Flange 6000
PSI

85

FS6L



90° SAE Flange 6000
Psi - Long Drop

85

S006

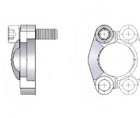

Cut Split Flanges -
6000 psi

86



130S

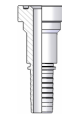

Straight 'CAT' Flange

86

110S



90° 'CAT' Flange

87

120S

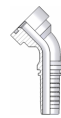

45° 'CAT' Flange

87



D050



Hose Junction

88



G500



Weldable Fitting

89

001C

Swaged Ferrule (No Skive)

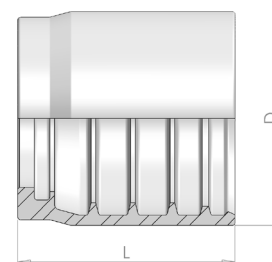

Part number	Hose I.D.		Dimensions		Skive
	in	mm	D	L	Length
001C-03	3/16	4,8	18.5	24	NO
001C-04	1/4	6.4	20	26	NO
001C-05	5/16	7.9	22	26	NO
001C-06	3/8	9.5	25	28	NO
001C-08	1/2	12.7	28	28	NO
001C-10	5/8	15.9	32	31	NO
001C-12	3/4	19	36	38	NO
001C-16	1	25.4	44	47.5	NO
001C-20	1.1/4	31.8	54	56	NO
001C-24	1.1/2	38.1	62	66	NO
001C-32	2	50.8	75	73	NO
001C-40	2.1/2	63,5	88	90	NO
001C-48	3	76,2	101	90	NO

0022

Swaged Ferrule (No Skive)

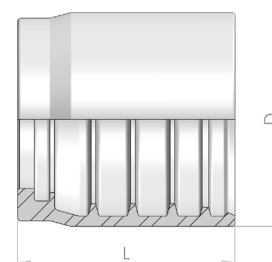

Part number	Hose I.D.		Dimensions		Skive
	in	mm	D	L	Length
0022-03	3/16	4.8	21	25.6	NO
0022-04	1/4	6.4	22	28	NO
0022-05	5/16	7.9	24	28	NO
0022-06	3/8	9.5	26	28	NO
0022-08	1/2	12.7	30	31	NO
0022-10	5/8	15.9	34	31	NO
0022-12	3/4	19	37	38	NO
0022-16	1	25.4	47	47.5	NO
0022-20	1.1/4	31.8	58	56	NO
0022-24	1.1/2	38.1	65.6	66	NO
0022-32	2	50.8	78.6	73	NO

0001

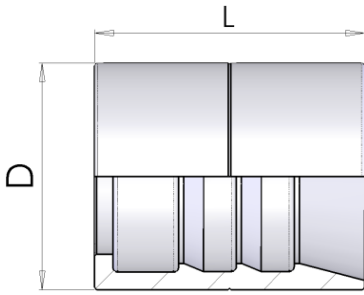

Swaged Ferrule (Skive)

Part number	Hose I.D.		Dimensions		Skive
	in	mm	D	L	Lenght
0001-03	3/16	4.8	17.5	27	20
0001-04	1/4	6.4	20	30.2	23
0001-05	5/16	7.9	22	30.7	23
0001-06	3/8	9.5	24	32	24
0001-08	1/2	12.7	28.5	34	25
0001-10	5/8	15.9	32	37	27
0001-12	3/4	19	36	43	31
0001-16	1	25.4	43	50	37
0001-20	1.1/4	31.8	52	57	46
0001-24	1.1/2	38.1	57	63	44
0001-32	2	50.8	70.6	78	60

0002

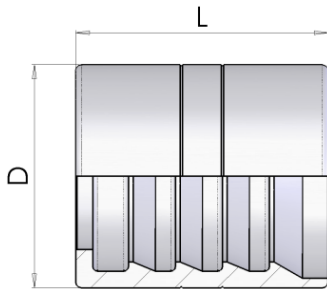

Swaged Ferrule (Skive)

Part number	Hose I.D.		Dimensions		Skive
	in	mm	D	L	Lenght
0002-03	3/16	4.8	20	27	21
0002-04	1/4	6.4	21	30	22
0002-05	5/16	7.9	24	30	22
0002-06	3/8	9.5	25.4	32	24
0002-08	1/2	12.7	30	34	25
0002-10	5/8	15.9	34	37	27
0002-12	3/4	19	38	43	31
0002-16	1	25.4	46	50	37
0002-20	1.1/4	31.8	56	59	43
0002-24	1.1/2	38.1	62	63	45
0002-32	2	50.8	75	79	61
0002-40	2.1/2	63.5	95	83.7	63
0002-48	3	76.2	105.6	94.3	78

003T

Swaged Ferrule (No Skive)

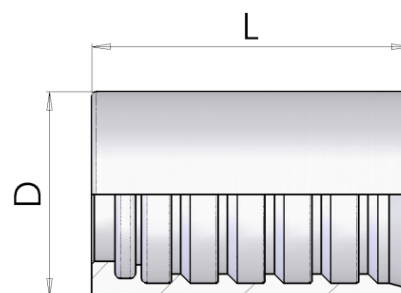

Part number	Hose I.D.		Dimensions		Skive
	in	mm	D	L	Lenght
003T-08	1/2	12.7	31	32.5	NO
003T-10	5/8	15.9	34	34	NO

0003

Swaged Ferrule (No Skive)

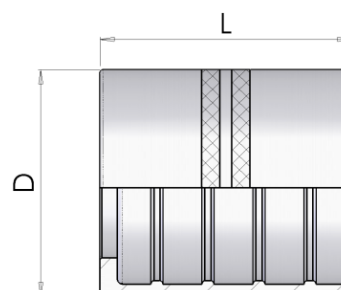

Part number	Hose I.D.		Dimensions		Skive
	in	mm	D	L	Lenght
0003-03	3/16	4.8	14	27	NO
0003-04	1/4	6.4	19	29	NO
0003-05	5/16	7.9	22	30	NO
0003-06	3/8	9.5	24	31	NO
0003-08	1/2	12.7	28.5	34	NO
0003-10	5/8	15.9	32	36	NO
0003-12	3/4	19	38	42	NO
0003-16	1	25.4	46	50	NO
0003-20	1.1/4	31.8	52	57	NO

0007

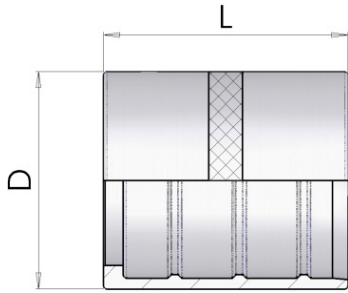

Swaged Ferrule (No Skive)

Part number	Hose I.D.		Dimensions		Skive
	in	mm	D	L	Lenght
0007-03	3/16	4.8	14	27	NO
0007-04	1/4	6.4	17	29	NO
0007-05	5/16	7.9	19	30	NO
0007-06	3/8	9.5	21	31	NO
0007-08	1/2	12.7	25.4	34	NO
0007-10	5/8	15.9	28.5	36	NO
0007-12	3/4	19	32	36	NO
0007-16	1	25.4	40	50	NO

0008

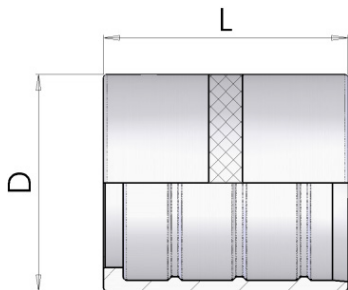

Swaged Ferrule (No Skive)

Part number	Hose I.D.		Dimensions		Skive
	in	mm	D	L	Lenght
0008-03	3/16	4.8	13	27	NO
0008-04	1/4	6.4	17	29	NO
0008-05	5/16	7.9	19	30	NO
0008-06	3/8	9.5	21.5	31	NO
0008-08	1/2	12.7	26	34	NO
0008-10	5/8	15.9	29	40	NO
0008-12	3/4	19	32	42	NO
0008-16	1	25.4	40	50	NO

PTFE

Ferrule for PTFE Hose

For PTFE Hose type T1-(with standard fittings)

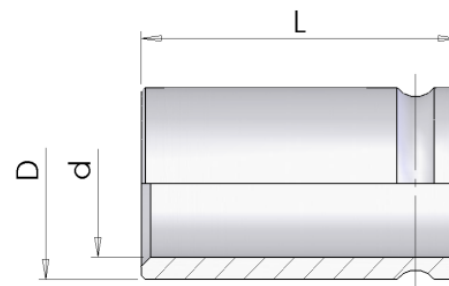

Part number	Hose I.D.		Dimensions		Dim	Skive
	in	mm	D	L	d	Lenght
PTFE-03	3/16	4.8	12.7	22	9.5	NO
PTFE-04	1/4	6.4	14.4	23.9	11.1	NO
PTFE-05	5/16	7.9	17.1	24.6	13	NO
PTFE-06	3/8	9.5	19	27.4	15	NO
PTFE-08	1/2	12.7	22.4	28.7	18.3	NO
PTFE-10	5/8	15.9	27	31.7	23.1	NO
PTFE-12	3/4	19	28.7	34.5	24.8	NO
PTFE-16	1	25.4	38.1	43.6	34.3	NO

PTFE-C

Ferrule for PTFE Hose

For PTFE Hose type LTC-(with standard fittings)

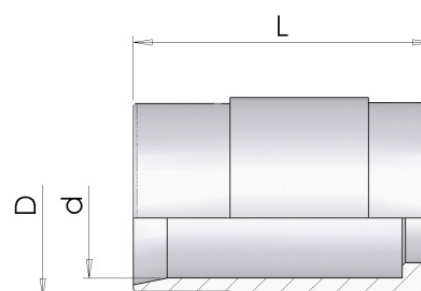

Part number	Hose I.D.		Dimensions		Dim	Skive
	in	mm	D	L	d	Lenght
PTFE-04-C	1/4	6.4	17.8	26.5	14.4	NO
PTFE-06-C	3/8	9.5	20	30.5	16.8	NO
PTFE-08-C	1/2	12.7	24	33.2	20.5	NO
PTFE-10-C	5/8	15.9	29.2	34.8	25.4	NO
PTFE-12-C	3/4	19	31.1	40.9	27.4	NO
PTFE-16-C	1	25.4	38.5	47	34.7	NO

0009

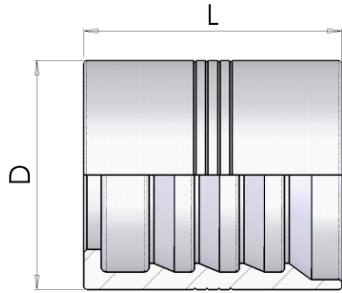

Swaged Ferrule (Skive)

Part number	Hose I.D.		Dimensions		Skive
	in	mm	D	L	Lenght
0009-04	1/4	6.4	21	30	22
0009-06	3/8	9.5	25.4	33.5	26
0009-08	1/2	12.7	30	36	28
0009-10	5/8	15.9	34	40	31
0009-12	3/4	19	38	43	34
0009-16	1	25.4	46	60	48
0009-20	1.1/4	31.8	56	66	54
0009-24	1.1/2	38.1	67	76.5	62
0009-32	2	50.8	80	79.8	64

004H

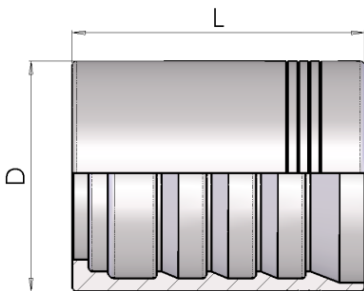

Swaged Ferrule (Skive)

Part number	Hose I.D.		Dimensions		Skive
	in	mm	D	L	Lenght
004H-20	1.1/4	31.8	52	66	55
004H-24	1.1/2	38.1	62	76.5	63
004H-32	2	50.8	75	79.8	65

BMC1

Swaged Ferrule (No Skive)

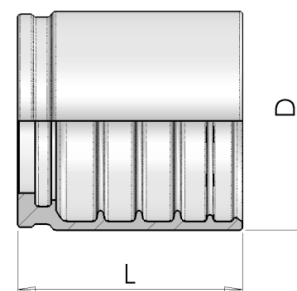

Part number	Hose I.D.		Dimensions		Skive Length
	in	mm	D	L	
BMC1-12	3/4	19	45	41	NO
BMC1-16	1	25.4	53.5	56	NO
BMC1-20	1.1/4	31.8	62	62	NO

BMC2

Swaged Ferrule (No Skive)

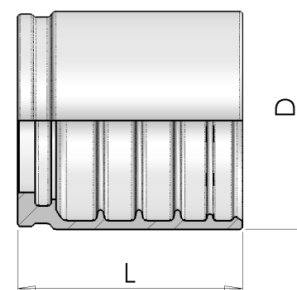

Part number	Hose I.D.		Dimensions		Skive Length
	in	mm	D	L	
BMC2-20	1.1/4	31.8	66	62	NO
BMC2-24	1.1/2	38.1	73.3	70	NO

0345

BSP Male - Flat Seat

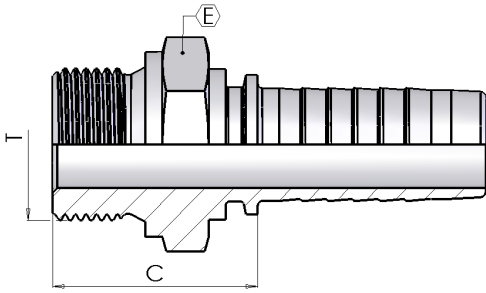

Part number	Hose I.D.		Dimensions			
	in	mm	Dash size	Thread T	Hex E	Cut-Off C
0345-03-02	3/16	4.8	03	1/8-28	14	21
0345-04-04	1/4	6.4	04	1/4-19	19	27
0345-04-06	1/4	6.4	04	3/8-19	22	28
0345-05-06	5/16	7.9	05	3/8-19	22	28
0345-06-06	3/8	9.5	06	3/8-19	22	29
0345-06-08	3/8	9.5	06	1/2-14	27	32
0345-08-08	1/2	12.7	08	1/2-14	27	33
0345-08-10	1/2	12.7	08	5/8-14	30	35
0345-08-12	1/2	12.7	08	3/4-14	32	35
0345-10-10	5/8	15.9	10	5/8-14	30	35
0345-10-12	5/8	15.9	10	3/4-14	32	35
0345-12-12	3/4	19	12	3/4-14	32	36
0345-12-16	3/4	19	12	1-11	41	39
0345-16-16	1	25.4	16	1-11	41	40

0060

BSP Female - Flat Seal

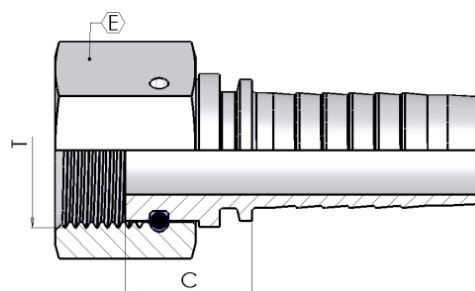

Part number	Hose I.D.		Dimensions			
	in	mm	Dash size	Thread T	Hex E	Cut-Off C
0060-04-04	1/4	6.4	04	1/4-19	19	14
0060-04-06	1/4	6.4	04	3/8-19	22	15
0060-05-04	5/16	7.9	05	1/4-19	19	14
0060-05-06	5/16	7.9	05	3/8-19	22	15
0060-05-08	5/16	7.9	05	1/2-14	27	17
0060-06-06	3/8	9.5	06	3/8-19	22	15
0060-06-08	3/8	9.5	06	1/2-14	27	16
0060-08-08	1/2	12.7	08	1/2-14	27	16
0060-08-10	1/2	12.7	08	5/8-14	30	16
0060-08-12	1/2	12.7	08	3/4-14	32	23
0060-10-10	5/8	15.9	10	5/8-14	30	16
0060-10-12	5/8	15.9	10	3/4-14	32	20
0060-12-12	3/4	19	12	3/4-14	32	21
0060-12-16	3/4	19	12	1-11	38	23
0060-16-16	1	25.4	16	1-11	38	22
0060-24-24	1.1/2	38.1	24	1.1/2-11	55	27

0350

BSP Male Parallel 60° Cone

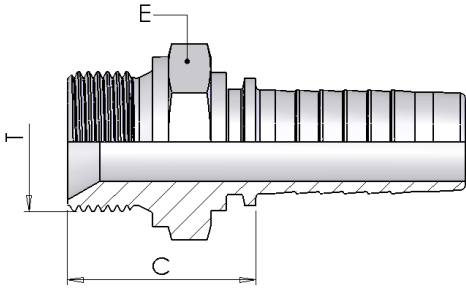

Part number	Hose I.D.		Dimensions			
	in	mm	Dash size	Thread T	Hex E	Cut-Off C
0350-03-02	3/16	4.8	03	1/8-28	14	21
0350-03-04	3/16	4.8	03	1/4-19	19	26
0350-04-02	1/4	6.4	04	1/8-28	14	21
0350-04-04	1/4	6.4	04	1/4-19	19	27
0350-04-06	1/4	6.4	04	3/8-19	22	28
0350-04-08	1/4	6.4	04	1/2-14	27	35
0350-05-04	5/16	7.9	05	1/4-19	19	27
0350-05-06	5/16	7.9	05	3/8-19	22	28
0350-05-08	5/16	7.9	05	1/2-14	27	32
0350-06-04	3/8	9.5	06	1/4-19	19	27
0350-06-06	3/8	9.5	06	3/8-19	22	29
0350-06-08	3/8	9.5	06	1/2-14	27	32
0350-08-06	1/2	12.7	08	3/8-19	22	29
0350-08-08	1/2	12.7	08	1/2-14	27	33
0350-08-10	1/2	12.7	08	5/8-14	30	34
0350-08-12	1/2	12.7	08	3/4-14	32	35
0350-10-08	5/8	15.9	10	1/2-14	27	33
0350-10-10	5/8	15.9	10	5/8-14	30	35
0350-10-12	5/8	15.9	10	3/4-14	32	35
0350-12-12	3/4	19	12	3/4-14	32	36
0350-12-16	3/4	19	12	1-11	41	39
0350-16-16	1	25.4	16	1-11	41	40
0350-16-20	1	25.4	16	1.1/4-11	50	44
0350-20-16	1.1/4	31.8	20	1-11	41	41
0350-20-20	1.1/4	31.8	20	1.1/4-11	50	45
0350-20-24	1.1/4	31.8	20	1.1/2-11	55	46
0350-24-24	1.1/2	38.1	24	1.1/2-11	55	46
0350-24-32	1.1/2	38.1	24	2-11	70	54
0350-32-24	2	50.8	32	1.1/2-11	65	50
0350-32-32	2	50.8	32	2-11	70	54

035G

BSP Male Parallel 60° Cone - Rotating

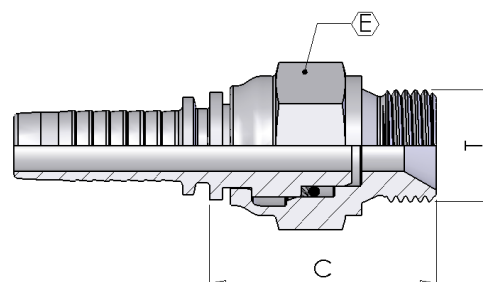

Part number	Hose I.D.		Dimensions			
	in	mm	Dash size	Thread T	Hex E	Cut-Off C
035G-04-04	1/4	6.4	04	1/4-19	19	37
035G-06-06	3/8	9.5	06	3/8-19	22	43
035G-08-08	1/2	12.7	08	1/2-14	27	47
035G-12-12	3/4	19	12	3/4-14	32	52

0051

BSP Female 60° Cone - Rolled Nut

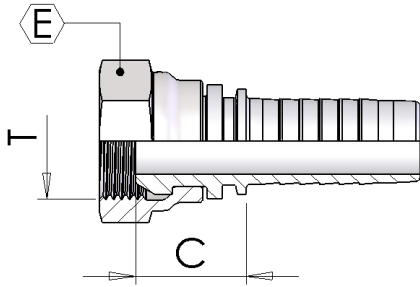

Part number	Hose I.D.		Dimensions			
	in	mm	Dash size	Thread T	Hex E	Cut-Off C
0051-03-02	3/16	4.8	03	1/8-28	14	15
0051-03-04	3/16	4.8	03	1/4-19	19	17
0051-04-02	1/4	6.4	04	1/8-28	14	15
0051-04-04	1/4	6.4	04	1/4-19	19	17
0051-04-06	1/4	6.4	04	3/8-19	22	19
0051-04-08	1/4	6.4	04	1/2-14	27	22
0051-05-04	5/16	7.9	05	1/4-19	19	17
0051-05-06	5/16	7.9	05	3/8-19	22	19
0051-05-08	5/16	7.9	05	1/2-14	27	22
0051-06-04	3/8	9.5	06	1/4-19	19	17
0051-06-06	3/8	9.5	06	3/8-19	22	19
0051-06-08	3/8	9.5	06	1/2-14	27	22
0051-08-06	1/2	12.7	08	3/8-19	22	20
0051-08-08	1/2	12.7	08	1/2-14	27	23
0051-08-10	1/2	12.7	08	5/8-14	30	20
0051-08-12	1/2	12.7	08	3/4-14	32	27
0051-10-08	5/8	15.9	10	1/2-14	27	23
0051-10-10	5/8	15.9	10	5/8-14	30	20
0051-10-12	5/8	15.9	10	3/4-14	32	25
0051-12-08	3/4	19	12	1/2-14	27	24
0051-12-12	3/4	19	12	3/4-14	32	25
0051-12-16	3/4	19	12	1-11	38	26
0051-16-12	1	25.4	16	3/4-14	32	27
0051-16-16	1	25.4	16	1-11	38	27

BSP Female 60° Cone - Thrust Wire

(*)- BSP female with O'Ring

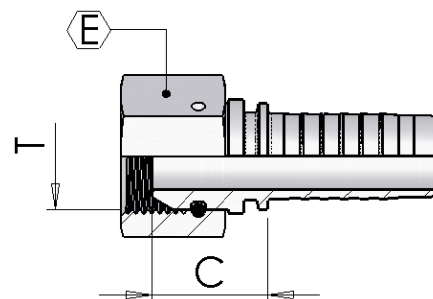
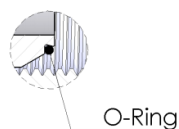

Part number	Hose I.D.		Dimensions			
	in	mm	Dash size	Thread T	Hex E	Cut-Off C
0050-03-02	3/16	4.8	03	1/8-28	14	15
0050-03-04	3/16	4.8	03	1/4-19	19	17
0050-04-02	1/4	6.4	04	1/8-28	14	15
0050-04-04	1/4	6.4	04	1/4-19	19	17
0050-04-06	1/4	6.4	04	3/8-19	22	19
0050-04-08	1/4	6.4	04	1/2-14	27	22
0050-05-04	5/16	7.9	05	1/4-19	19	17
0050-05-06	5/16	7.9	05	3/8-19	22	19
0050-05-08	5/16	7.9	05	1/2-14	27	22
0050-06-04	3/8	9.5	06	1/4-19	19	17
0050-06-06	3/8	9.5	06	3/8-19	22	19
0050-06-08	3/8	9.5	06	1/2-14	27	22
0050-08-06	1/2	12.7	08	3/8-19	22	20
0050-08-08	1/2	12.7	08	1/2-14	27	23
0050-08-10	1/2	12.7	08	5/8-14	30	20
0050-08-12	1/2	12.7	08	3/4-14	32	27
0050-10-08	5/8	15.9	10	1/2-14	27	23
0050-10-10	5/8	15.9	10	5/8-14	30	20
0050-10-12	5/8	15.9	10	3/4-14	32	25
0050-12-08	3/4	19	12	1/2-14	27	24
0050-12-12	3/4	19	12	3/4-14	32	25
0050-12-16	3/4	19	12	1-11	38	26
0050-16-12	1	25.4	16	3/4-14	32	27
0050-16-16	1	25.4	16	1-11	38	27
(*) 0050-16-20	1	25.4	16	1.1/4-11	50	30
(*) 0050-20-20	1.1/4	31.8	20	1.1/4-11	50	32
(*) 0050-20-24	1.1/4	31.8	20	1.1/2-11	55	34
(*) 0050-24-24	1.1/2	38.1	24	1.1/2-11	55	34
(*) 0050-24-32	1.1/2	38.1	24	2-11	70	34
(*) 0050-32-32	2	50.8	32	2-11	70	31
0050-40-40	2.1/2	63,5	40	2.1/2-11	85	41
0050-48-48	3	76,2	48	3-11	100	45

0052

BSP Female 60° Cone - Slip On Nut

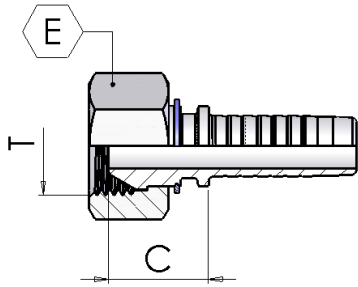

Part number	Hose I.D.		Dimensions			
	in	mm	Dash size	Thread T	Hex E	Cut-Off C
0052-04-04	1/4	6.4	04	1/4-19	17	17
0052-06-06	3/8	9.5	06	3/8-19	19	17
0052-08-08	1/2	12.7	08	1/2-14	27	21

0041

BSP O'Ring Female 60° Cone - Rolled Nut

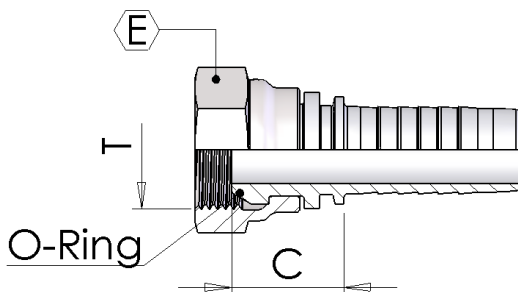

Part number	Hose I.D.		Dimensions			
	in	mm	Dash size	Thread T	Hex E	Cut-Off C
0041-04-04	1/4	6.4	04	1/4-19	19	17
0041-06-06	3/8	9.5	06	3/8-19	22	19
0041-08-08	1/2	12.7	08	1/2-14	27	21
0041-10-10	5/8	15.9	10	5/8-14	30	21
0041-12-12	3/4	19	12	3/4-14	32	26
0041-16-16	1	25.4	16	1-11	38	28

0040

BSP O'Ring Female 60° Cone - Thrust Wire

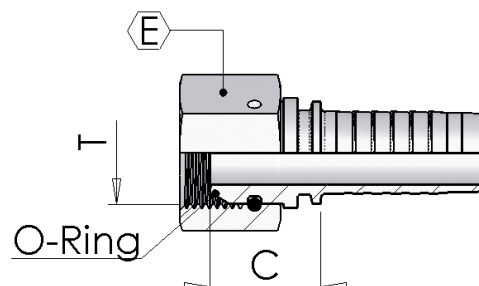

Part number	Hose I.D.		Dimensions			
	in	mm	Dash size	Thread T	Hex E	Cut-Off C
0040-10-10	5/8	15.9	10	5/8-14	30	21
0040-12-12	3/4	19	12	3/4-14	32	26
0040-16-16	1	25.4	16	1-11	38	28

0042

BSP O'Ring Female 60° Cone - Slip On Nut

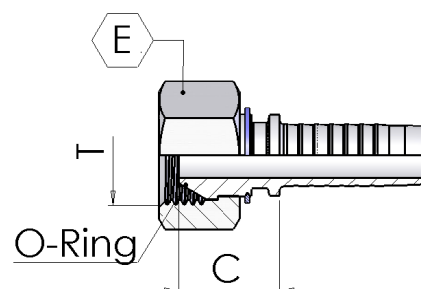

Part number	Hose I.D.		Dimensions			
	in	mm	Dash size	Thread T	Hex E	Cut-Off C
0042-04-04	1/4	6.4	04	1/4-19	17	17
0042-06-06	3/8	9.5	06	3/8-19	19	17
0042-08-08	1/2	12.7	08	1/2-14	27	20

0151

BSP 90° Swept Elbow 60° Cone - Rolled Nut

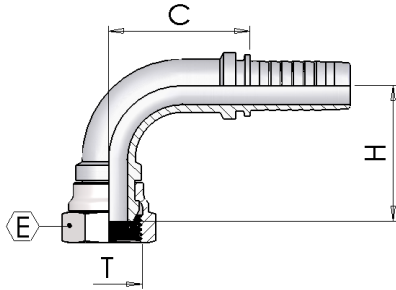

Part number	Hose I.D.		Dimensions				
	in	mm	Dash size	Thread T	Hex E	C	H
0151-03-02	3/16	4.8	03	1/8-28	14	22	23
0151-03-04	3/16	4.8	03	1/4-19	19	22	25
0151-04-02	1/4	6.4	04	1/8-28	14	25	25
0151-04-04	1/4	6.4	04	1/4-19	19	25	27
0151-04-06	1/4	6.4	04	3/8-19	22	25	31
0151-05-04	5/16	7.9	05	1/4-19	19	31	31
0151-05-06	5/16	7.9	05	3/8-19	22	29	36
0151-06-04	3/8	9.5	06	1/4-19	19	31	33
0151-06-06	3/8	9.5	06	3/8-19	22	33	35
0151-06-08	3/8	9.5	06	1/2-14	27	31	40
0151-08-06	1/2	12.7	08	3/8-19	22	39	42
0151-08-08	1/2	12.7	08	1/2-14	27	39	41
0151-08-10	1/2	12.7	08	5/8-14	30	40	41
0151-08-12	1/2	12.7	08	3/4-14	32	41	46
0151-10-10	5/8	15.9	10	5/8-14	30	43	43
0151-10-12	5/8	15.9	10	3/4-14	32	45	50
0151-12-12	3/4	19	12	3/4-14	32	56	57
0151-12-16	3/4	19	12	1-11	38	56	60
0151-16-16	1	25.4	16	1-11	38	70	67

BSP 90° Swept Elbow 60° Cone - Thrust Wire

(*)-On request available in version without O'Ring

(*)- BSP female with O'Ring

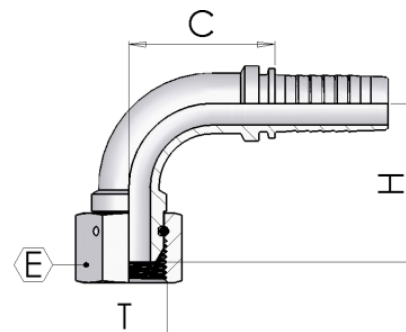
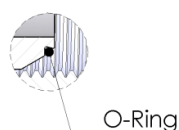

Part number	Hose I.D.		Dimensions				
	in	mm	Dash size	Thread T	Hex E	Cut-Off C	H
0150-03-02	3/16	4.8	03	1/8-28	14	22	23
0150-03-04	3/16	4.8	03	1/4-19	19	22	25
0150-04-02	1/4	6.4	04	1/8-28	14	25	25
0150-04-04	1/4	6.4	04	1/4-19	19	25	27
0150-04-06	1/4	6.4	04	3/8-19	22	25	31
0150-05-04	5/16	7.9	05	1/4-19	19	31	31
0150-05-06	5/16	7.9	05	3/8-19	22	29	36
0150-06-04	3/8	9.5	06	1/4-19	19	31	33
0150-06-06	3/8	9.5	06	3/8-19	22	33	35
0150-06-08	3/8	9.5	06	1/2-14	27	31	40
0150-08-06	1/2	12.7	08	3/8-19	22	39	42
0150-08-08	1/2	12.7	08	1/2-14	27	39	41
0150-08-10	1/2	12.7	08	5/8-14	30	40	41
0150-08-12	1/2	12.7	08	3/4-14	32	41	46
0150-10-10	5/8	15.9	10	5/8-14	30	44	43
0150-10-12	5/8	15.9	10	3/4-14	32	45	50
0150-12-12	3/4	19	12	3/4-14	32	56	57
0150-12-16	3/4	19	12	1-11	38	56	60
Welded 0150S16-12	1	25.4	16	3/4-14	32	57	68
0150-16-16	1	25.4	16	1-11	38	70	67
Welded (*) 0150S16-20	1	25.4	16	1.1/4-11	50	62	72
(*) 0150-20-20	1.1/4	31.8	20	1.1/4-11	50	86	81
Welded (*) 0150S20-24	1.1/4	31.8	20	1.1/2-11	55	81	89
(*) 0150-24-24	1.1/2	38.1	24	1.1/2-11	55	103	95
Welded (*) 0150S24-32	1.1/2	38.1	24	2-11	70	102	113
(*) 0150-32-32	2	50.8	32	2-11	70	122	135

0152

BSP 90° Swept Elbow 60° Cone - Slip On Nut

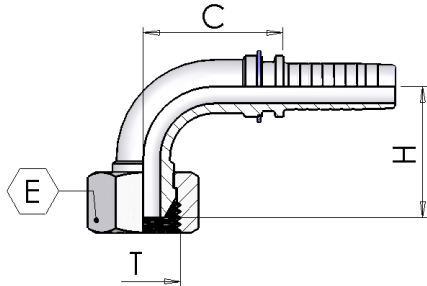

Part number	Hose I.D.		Dimensions				
	in	mm	Dash size	Thread T	Hex E	C	H
0152-04-04	1/4	6.4	04	1/4-19	17	27	26
0152-06-06	3/8	9.5	06	3/8-19	19	34	30
0152-08-08	1/2	12.7	08	1/2-14	27	42	38

0141

BSP O'Ring 90° Swept Elbow 60° Cone - Rolled Nut

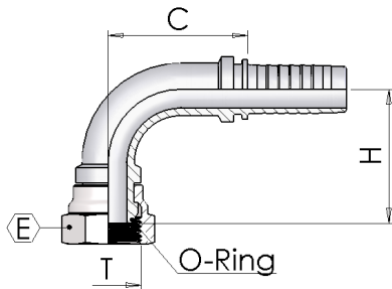

Part number	Hose I.D.		Dimensions				
	in	mm	Dash size	Thread T	Hex E	C	H
0141-04-04	1/4	6.4	04	1/4-19	19	25	27
0141-06-06	3/8	9.5	06	3/8-19	22	33	34
0141-08-08	1/2	12.7	08	1/2-14	27	41	40
0141-10-10	5/8	15.9	10	5/8-14	30	43	55
0141-12-12	3/4	19	12	3/4-14	32	56	54
0141-16-16	1	25.4	16	1-11	38	70	67

0140

BSP O'Ring 90° Swept Elbow 60° Cone - Thrust Wire Nut

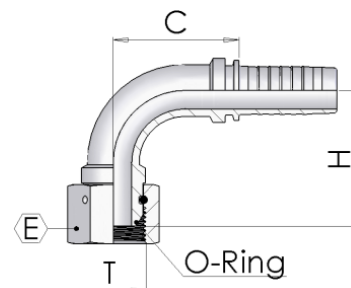

Part number	Hose I.D.		Dimensions				
	in	mm	Dash size	Thread T	Hex E	C	H
0140-10-10	5/8	15.9	10	5/8-14	30	44	43
0140-12-12	3/4	19	12	3/4-14	32	56	54
0140-16-16	1	25.4	16	1-11	38	70	67

0142

BSP O'Ring 90° Swept Elbow 60° Cone - Slip on nut

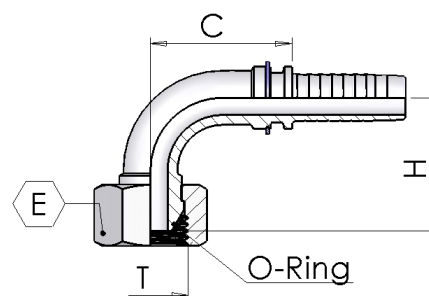

Part number	Hose I.D.		Dimensions				
	in	mm	Dash size	Thread T	Hex E	C	H
0142-04-04	1/4	6.4	04	1/4-19	17	27	24
0142-06-06	3/8	9.5	06	3/8-19	19	34	28
0142-08-08	1/2	12.7	08	1/2-14	27	42	37

2300

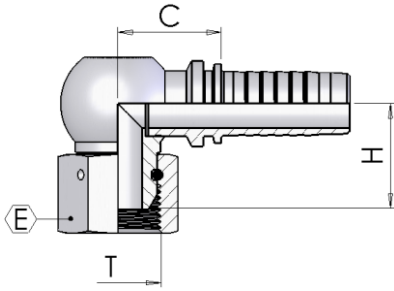

BSP 90° Compact Elbow 60° Cone - Thrust wire - Welded

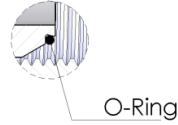

(*)- BSP female with O'Ring

Part number	Hose I.D.		Dimensions				
	in	mm	Dash size	Thread T	Hex E	C	H
2300-03-02	3/16	4.8	03	1/8-28	14	17	16
2300-10-10	5/8	15.9	10	5/8-14	30	28	27
2300-10-12	5/8	15.9	10	3/4-14	32	29	32
(*) 2300-20-20	1.1/4	31.8	20	1.1/4-11	50	47	46

2301

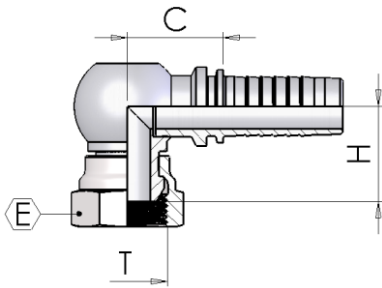

BSP 90° Compact Elbow 60° Cone - Rolled Nut - Welded

Part number	Hose I.D.		Dimensions				
	in	mm	Dash size	Thread T	Hex E	C	H
2301-03-02	3/16	4.8	03	1/8-28	14	17	16
2301-10-10	5/8	15.9	10	5/8-14	30	28	27
2301-10-12	5/8	15.9	10	3/4-14	32	29	32

2320

BSP 90° Compact Elbow 60° Cone - Thrust wire

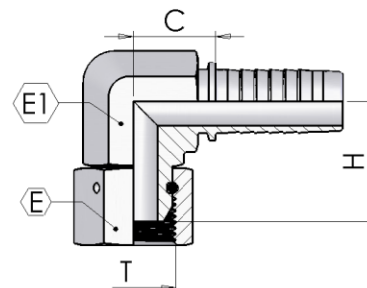

Part number	Hose I.D.		Dimensions					
	in	mm	Dash size	Thread T	Hex E	C	H	E1
2320-04-04	1/4	6.4	04	1/4-19	19	19	20	15
2320-04-06	1/4	6.4	04	3/8-19	22	24	29	17
2320-05-06	5/16	7.9	05	3/8-19	22	24	23	17
2320-06-06	3/8	9.5	06	3/8-19	22	23	23	17
2320-06-08	3/8	9.5	06	1/2-14	27	28	26	19
2320-08-08	1/2	12.7	08	1/2-14	27	26	27	22
2320-12-12	3/4	19	12	3/4-14	32	32	32	27
2320-16-16	1	25.4	16	1-11	38	38	36	32

2321

BSP 90° Compact Elbow 60° Cone - Rolled Nut

(*)- BSP female with O'Ring

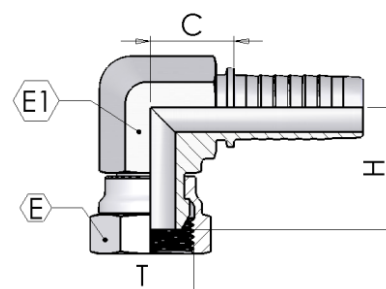
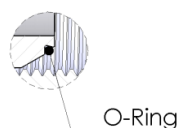

Part number	Hose I.D.		Dimensions					
	in	mm	Dash size	Thread T	Hex E	C	H	E1
(*) 2321-04-04	1/4	6.4	04	1/4-19	19	19	20	15
2321-04-06	1/4	6.4	04	3/8-19	22	24	29	17
2321-05-06	5/16	7.9	05	3/8-19	22	24	23	17
(*) 2321-06-06	3/8	9.5	06	3/8-19	22	23	23	17
2321-06-08	3/8	9.5	06	1/2-14	27	28	26	19
(*) 2321-08-08	1/2	12.7	08	1/2-14	27	26	27	22
2321-12-12	3/4	19	12	3/4-14	32	32	32	27
2321-16-16	1	25.4	16	1-11	38	38	36	32

0251

BSP 45° Swept Elbow 60° Cone - Rolled Nut

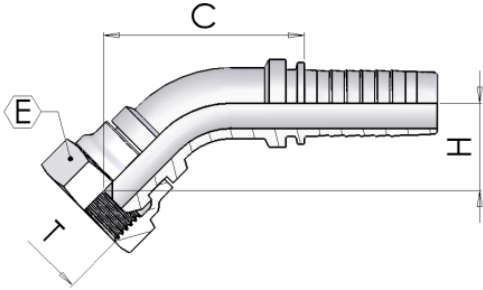

Part number	Hose I.D.		Dimensions				
	in	mm	Dash size	Thread T	Hex E	C	H
0251-03-02	3/16	4.8	03	1/8-28	14	33	15
0251-03-04	3/16	4.8	03	1/4-19	19	35	15
0251-04-02	1/4	6.4	04	1/8-28	14	40	14
0251-04-04	1/4	6.4	04	1/4-19	19	41	15
0251-05-04	5/16	7.9	05	1/4-19	19	47	16
0251-05-06	5/16	7.9	05	3/8-19	22	51	19
0251-06-04	3/8	9.5	06	1/4-19	19	50	16
0251-06-06	3/8	9.5	06	3/8-19	22	52	19
0251-06-08	3/8	9.5	06	1/2-14	27	55	21
0251-08-06	1/2	12.7	08	3/8-19	22	63	22
0251-08-08	1/2	12.7	08	1/2-12	27	65	24
0251-08-10	1/2	12.7	08	5/8-14	30	64	21
0251-08-12	1/2	12.7	08	3/4-14	32	67	26
0251-10-08	5/8	15.9	10	1/2-14	27	68	24
0251-10-10	5/8	15.9	10	5/8-14	30	68	23
0251-10-12	5/8	15.9	10	3/4-14	32	72	27
0251-12-12	3/4	19	12	3/4-14	32	86	30
0251-12-16	3/4	19	12	1-11	38	88	32
0251-16-16	1	25.4	16	1-11	38	107	35

BSP 45° Swept Elbow 60° Cone -Thrust Wire Nut

(*)- BSP female with O'Ring

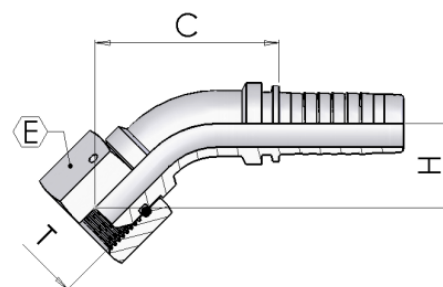
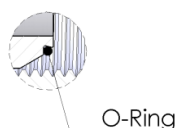

(*)-On request available in version without O'Ring

Part number	Hose I.D.		Dimensions				
	in	mm	Dash size	Thread T	Hex E	C	H
0250-03-02	3/16	4.8	03	1/8-28	14	33	15
0250-03-04	3/16	4.8	03	1/4-19	19	35	15
0250-04-02	1/4	6.4	04	1/8-28	14	40	14
0250-04-04	1/4	6.4	04	1/4-19	19	41	15
0250-04-06	1/4	6.4	04	3/8-19	22	44	18
0250-05-04	5/16	7.9	05	1/4-19	19	47	16
0250-05-06	5/16	7.9	05	3/8-19	22	51	19
0250-06-04	3/8	9.5	06	1/4-19	19	50	16
0250-06-06	3/8	9.5	06	3/8-19	22	52	19
0250-06-08	3/8	9.5	06	1/2-14	27	55	21
0250-08-06	1/2	12.7	08	3/8-19	22	63	22
0250-08-08	1/2	12.7	08	1/2-14	27	65	24
0250-10-10	5/8	15.9	10	5/8-14	30	68	23
0250-10-12	5/8	15.9	10	3/4-14	32	72	27
0250-12-12	3/4	19	12	3/4-14	32	86	30
0250-12-16	3/4	19	12	1-11	38	88	32
0250-16-16	1	25.4	16	1-11	38	107	35
Welded (*) 0250S16-20	1	25.4	16	1.1/4-11	50	70	33
(*) 0250-20-20	1.1/4	31.8	20	1.1/4-11	50	107	40
Welded (*) 0250S20-24	1.1/4	31.8	20	1.1/2-11	55	91	41
(*) 0250-24-24	1.1/2	38.1	24	1.1/2-11	55	117	47
(*) 0250-32-32	2	50.8	32	2-11	70	142	65

0252

BSP 45° Swept Elbow 60° Cone -Slip on nut

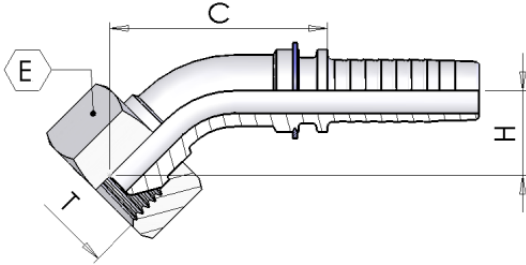

Part number	Hose I.D.		Dimensions				
	in	mm	Dash size	Thread T	Hex E	C	H
0252-04-04	1/4	6.4	04	1/4-19	17	41	15
0252-06-06	3/8	9.5	06	3/8-19	19	49	15
0252-08-08	1/2	12.7	08	1/2-14	27	61	19

0241

BSP O'Ring 45° Swept Elbow 60° Cone - Rolled Nut

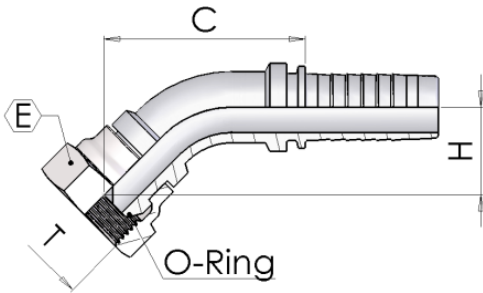

Part number	Hose I.D.		Dimensions				
	in	mm	Dash size	Thread T	Hex E	C	H
0241-04-04	1/4	6.4	04	1/4-19	19	41	15
0241-06-06	3/8	9.5	06	3/8-19	22	52	21
0241-08-08	1/2	12.7	08	1/2-14	27	63	22
0241-10-10	5/8	15.9	10	5/8-14	30	68	23
0241-12-12	3/4	19	12	3/4-14	32	88	28
0241-16-16	1	25.4	16	1-11	38	83	32

0240

BSP O'Ring 45° Swept Elbow 60° Cone - Thrust Wire Nut

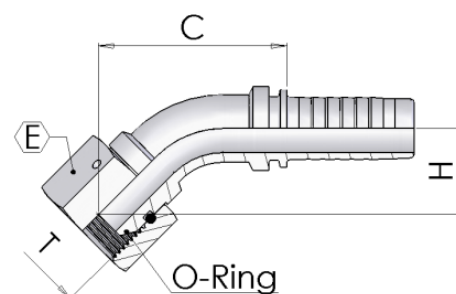

Part number	Hose I.D.		Dimensions				
	in	mm	Dash size	Thread T	Hex E	C	H
0240-10-10	5/8	15.9	10	5/8-14	30	68	23
0240-12-12	3/4	19	12	3/4-14	32	88	28
0240-16-16	1	25.4	16	1-11	38	83	32

0242

BSP O'Ring 45° Swept Elbow 60° Cone - Slip on nut

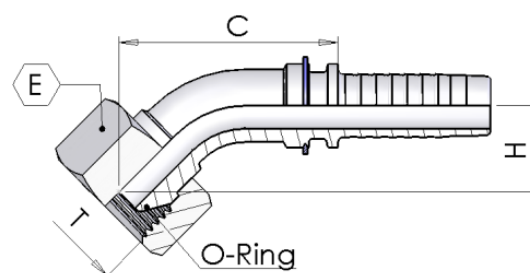

Part number	Hose I.D.		Dimensions				
	in	mm	Dash size	Thread T	Hex E	C	H
0242-04-04	1/4	6.4	04	1/4-19	17	41	15
0242-06-06	3/8	9.5	06	3/8-19	19	49	15
0242-08-08	1/2	12.7	08	1/2-14	27	61	19

0360

BSP Taper Male 60° Cone

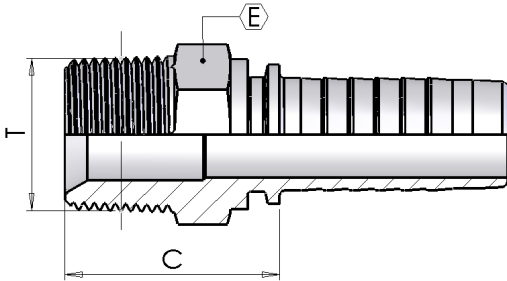

Part number	Hose I.D.		Dimensions			
	in	mm	Dash size	Thread T	Hex E	Cut-Off C
0360-03-02	3/16	4.8	03	1/8-28	12	21
0360-03-04	3/16	4.8	03	1/4-19	15	27
0360-04-02	1/4	6.4	04	1/8-28	12	22
0360-04-04	1/4	6.4	04	1/4-19	15	28
0360-04-06	1/4	6.4	04	3/8-19	19	28
0360-05-04	5/16	7.9	05	1/4-19	15	28
0360-05-06	5/16	7.9	05	3/8-19	19	28
0360-06-04	3/8	9.5	06	1/4-19	17	28
0360-06-06	3/8	9.5	06	3/8-19	19	28
0360-06-08	3/8	9.5	06	1/2-14	22	33
0360-08-06	1/2	12.7	08	3/8-19	19	29
0360-08-08	1/2	12.7	08	1/2-14	22	34
0360-08-12	1/2	12.7	08	3/4-14	27	36
0360-10-08	5/8	15.9	10	1/2-14	22	34
0360-10-10	5/8	15.9	10	5/8-14	24	35
0360-10-12	5/8	15.9	10	3/4-14	27	36
0360-12-12	3/4	19	12	3/4-14	27	37
0360-12-16	3/4	19	12	1-11	36	43
0360-16-16	1	25.4	16	1-11	36	44
0360-16-20	1	25.4	16	1.1/4-11	46	46
0360-20-20	1.1/4	31.8	20	1.1/4-11	46	47
0360-20-24	1.1/4	31.8	20	1.1/2-11	50	49
0360-24-24	1.1/2	38.1	24	1.1/2-11	50	49
0360-24-32	1.1/2	38.1	24	2-11	65	55
0360-32-32	2	50.8	32	2-11	65	55

BSP Banjo

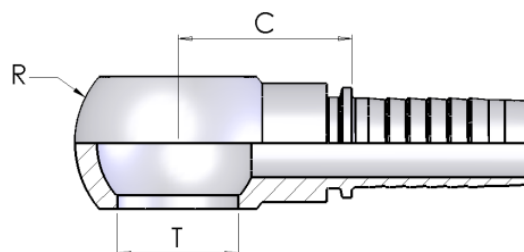

Part number	Hose I.D.		Dimensions				
	in	mm	Dash size	Hole T	mm	Cut-Off C	R
1400-03-02	3/16	4.8	03	1/8-28	10.2	19	17
1400-03-04	3/16	4.8	03	1/4-19	13.3	26	24
1400-04-02	1/4	6.4	04	1/8-28	10.2	25	17
1400-04-04	1/4	6.4	04	1/4-19	13.3	26	24
1400-04-06	1/4	6.4	04	3/8-19	17	26	28
1400-05-04	5/16	7.9	05	1/4-19	13.3	26	24
1400-05-06	5/16	7.9	05	3/8-19	17	26	28
1400-06-04	3/8	9.5	06	1/4-19	13.3	26	24
1400-06-06	3/8	9.5	06	3/8-19	17	26	28
1400-06-08	3/8	9.5	06	1/2-14	21.2	31	36
1400-08-06	1/2	12.7	08	3/8-19	17	27	28
1400-08-08	1/2	12.7	08	1/2-14	21.2	31	36
1400-08-10	1/2	12.7	08	5/8-14	23.1	29	38
1400-08-12	1/2	12.7	08	3/4-14	26.5	38	45
1400-10-10	5/8	15.9	10	5/8-14	23.1	29	39
1400-10-12	5/8	15.9	10	3/4-14	26.5	38	45
1400-12-12	3/4	19	12	3/4-14	26.5	38	45
1400-12-16	3/4	19	12	1-11	33.5	49	58
1400-16-16	1	25.4	16	1-11	33.5	50	58

1600

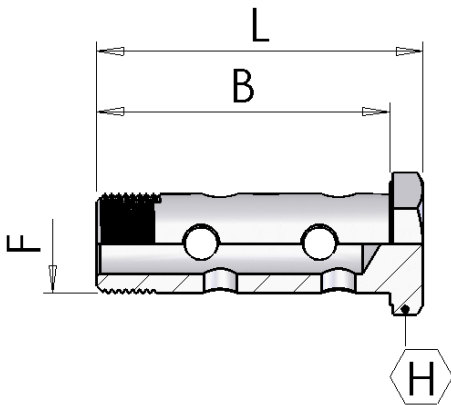

Double BSP Perforated Bolt

Part number	Dimensions			
	B	F	H	L
1600-04-04	43	1/4-19	19	49
1600-06-06	49	3/8-19	22	57
1600-08-08	62	1/2-14	27	70
1600-12-12	78	3/4-14	32	87
1600-16-16	98	1-11	41	109

1600-00

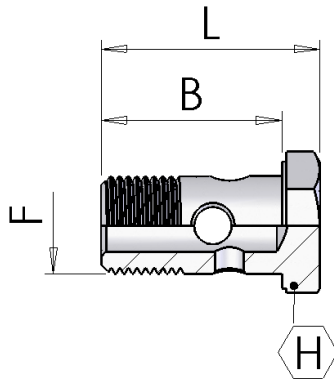

BSP Perforated Bolt

Part number	Dimensions			
	B	F	H	L
1600-00-02	19	1/8-28	14	24
1600-00-04	29	1/4-19	19	34
1600-00-06	33	3/8-19	22	41
1600-00-08	38	1/2-14	27	46
1600-00-10	44	5/8-14	30	54
1600-00-12	47	3/4-14	32	56
1600-00-16	58	1-11	41	69

NPTF Male 60° Cone

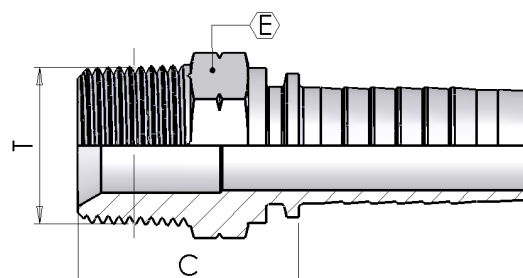

Part number	Hose I.D.		Dimensions			
	in	mm	Dash size	Thread T	Hex E	Cut-Off C
0370-03-02	3/16	4.8	03	1/8-27	12	22
0370-03-04	3/16	4.8	03	1/4-18	15	27
0370-04-02	1/4	6.4	04	1/8-27	12	22
0370-04-04	1/4	6.4	04	1/4-18	15	28
0370-04-06	1/4	6.4	04	3/8-18	19	28
0370-05-04	5/16	7.9	05	1/4-18	15	28
0370-05-06	5/16	7.9	05	3/8-18	19	28
0370-05-08	5/16	7.9	05	1/2-14	22	34
0370-06-04	3/8	9.5	06	1/4-18	17	28
0370-06-06	3/8	9.5	06	3/8-18	19	28
0370-06-08	3/8	9.5	06	1/2-14	22	34
0370-08-06	1/2	12.7	08	3/8-18	19	29
0370-08-08	1/2	12.7	08	1/2-14	22	35
0370-08-12	1/2	12.7	08	3/4-14	27	36
0370-10-08	5/8	15.9	10	1/2-14	24	35
0370-10-12	5/8	15.9	10	3/4-14	27	36
0370-12-08	3/4	19	12	1/2-14	24	36
0370-12-12	3/4	19	12	3/4-14	27	37
0370-12-16	3/4	19	12	1-11.1/2	36	43
0370-16-16	1	25.4	16	1-11.1/2	36	44
0370-16-20	1	25.4	16	1.1/4-11.1/2	46	46
0370-20-16	1.1/4	31.8	20	1-11.1/2	41	45
0370-20-20	1.1/4	31.8	20	1.1/4-11.1/2	46	47
0370-24-24	1.1/2	38.1	24	1.1/2-11.1/2	50	49
0370-32-32	2	50.8	32	2-11.1/2	65	55
0370-40-40	2.1/2	63,5	40	2.1/2-8	80	55
0370-48-48	3	76,2	48	3-8	90	58

037G

NPTF Male Parallel 60° Cone -Rotating

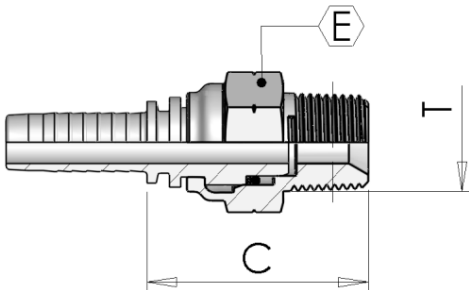

Part number	Hose I.D.		Dimensions			
	in	mm	Dash size	Thread T	Hex E	Cut-Off C
037G-04-04	1/4	6.4	04	1/4-18	19	39
037G-06-06	3/8	9.5	06	3/8-18	22	43
037G-08-08	1/2	12.7	08	1/2-14	27	49
037G-12-12	3/4	19	12	3/4-14	32	52

N051

NPSM Female 60° Cone Rolled Nut

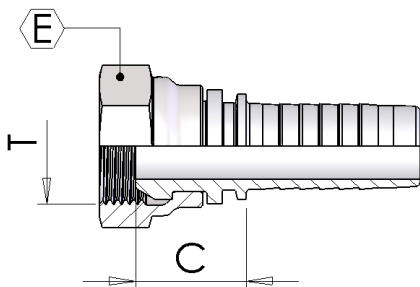

Part number	Hose I.D.		Dimensions			
	in	mm	Dash size	Thread T	Hex E	Cut-Off C
N051-03-04	3/16	4.8	03	1/4-18	19	17
N051-04-04	1/4	6.4	04	1/4-18	19	17
N051-06-06	3/8	9.5	06	3/8-18	22	19
N051-08-08	1/2	12.7	08	1/2-14	27	23

0850

JIC Male 74° Cone

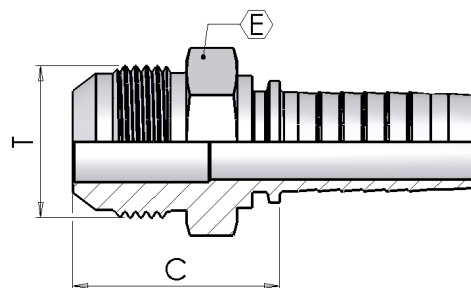

* SAE 45°

Part number	Hose I.D.		Dimensions			
	in	mm	Dash size	Thread T	Hex E	Cut-Off C
0850-03-04	3/16	4.8	03	7/16-20	12	26
0850-04-04	1/4	6.4	04	7/16-20	12	27
0850-04-05	1/4	6.4	04	1/2-20	14	27
0850-04-06	1/4	6.4	04	9/16-18	15	27
0850-05-05	5/16	7.9	05	1/2-20	14	27
0850-05-06	5/16	7.9	05	9/16-18	15	27
0850-05-08	5/16	7.9	05	3/4-16	19	30
0850-06-06	3/8	9.5	06	9/16-18	15	27
0850-06-07	3/8	9.5	06	5/8-18	17	30
0850-06-08	3/8	9.5	06	3/4-16	19	30
0850-06-10	3/8	9.5	06	7/8-14	24	34
0850-08-06	1/2	12.7	08	9/16-18	19	28
0850-08-08	1/2	12.7	08	3/4-16	19	31
0850-08-10	1/2	12.7	08	7/8-14	24	35
0850-08-12	1/2	12.7	08	1.1/16-12	27	37
0850-10-10	5/8	15.9	10	7/8-14	24	35
0850-10-12	5/8	15.9	10	1.1/16-12	27	37
0850-12-10	3/4	19	12	7/8-14	24	36
0850-12-12	3/4	19	12	1.1/16-12	27	38
0850-12-14	3/4	19	12	1.3/16-12	32	41
0850-12-16	3/4	19	12	1.5/16-12	34	42
0850-12-20	3/4	19	12	1.5/8-12	42	45
0850-16-12	1	25.4	16	1.1/16-12	27	39
0850-16-14	1	25.4	16	1.3/16-12	32	42
0850-16-16	1	25.4	16	1.5/16-12	34	43
0850-16-20	1	25.4	16	1.5/8-12	42	46
0850-20-20	1.1/4	31.8	20	1.5/8-12	42	47
0850-20-24	1.1/4	31.8	20	1.7/8-12	50	52
0850-24-24	1.1/2	38.1	24	1.7/8-12	50	52
0850-32-32	2	50.8	32	2.1/2-12	65	62

0901

JIC Female 74° Cone - Rolled Nut

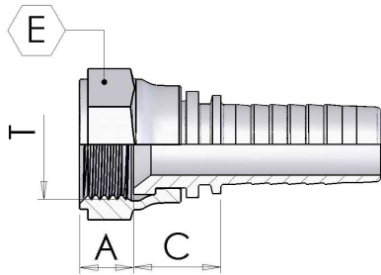

Part number	Hose I.D.		Dimensions				
	in	mm	Dash size	Thread T	Hex E	Cut-Off C	A
0901-03-04	3/16	4.8	03	7/16-20	15	14	8.5
0901-03-05	3/16	4.8	03	1/2-20	17	14	9.5
0901-04-04	1/4	6.4	04	7/16-20	15	14	8.5
0901-04-05	1/4	6.4	04	1/2-20	17	15	9.5
0901-04-06	1/4	6.4	04	9/16-18	19	16	9
*SAE 45° 0901-04-07	1/4	6.4	04	5/8-18	22	17	11
0901-05-05	5/16	7.9	05	1/2-20	17	17	9.5
0901-05-06	5/16	7.9	05	9/16-18	19	16	9
*SAE 45° 0901-05-07	5/16	7.9	05	5/8-18	22	17	11
0901-05-08	5/16	7.9	05	3/4-16	24	17	10.5
0901-06-04	3/8	9.5	06	7/16-20	15	15	9
0901-06-05	3/8	9.5	06	1/2-20	17	15	9.5
0901-06-06	3/8	9.5	06	9/16-18	19	16	9
*SAE 45° 0901-06-07	3/8	9.5	06	5/8-18	22	16	11
0901-06-08	3/8	9.5	06	3/4-16	24	17	10.5
0901-06-10	3/8	9.5	06	7/8-14	27	21	13
0901-08-08	1/2	12.7	08	3/4-16	24	18	10.5
0901-08-10	1/2	12.7	08	7/8-14	27	19	13
0901-08-12	1/2	12.7	08	1.1/16-12	32	24	13.5
0901-10-10	5/8	15.9	10	7/8-14	27	19	13
0901-10-12	5/8	15.9	10	1.1/16-12	32	21	13.5
0901-12-10	3/4	19	12	7/8-14	27	20	13
0901-12-12	3/4	19	12	1.1/16-12	32	22	13.5
0901-12-14	3/4	19	12	1.3/16-12	36	23	14
0901-12-16	3/4	19	12	1.5/16-12	38	23	15.5
0901-16-12	1	25.4	16	1.1/16-12	32	23	13.5
0901-16-16	1	25.4	16	1.5/16-12	38	24	15.5

JIC Female 74° - Thrust Wire Nut

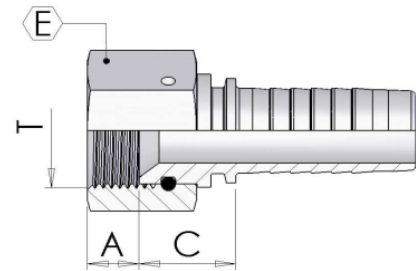

Part number	Hose I.D.		Dimensions				
	in	mm	Dash size	Thread T	Hex E	Cut-Off C	A
0900-03-04	3/16	4.8	03	7/16-20	17	14	8.5
0900-04-04	1/4	6.4	04	7/16-20	17	14	8.5
0900-04-05	1/4	6.4	04	1/2-20	17	15	9.5
0900-04-06	1/4	6.4	04	9/16-18	19	16	9
0900-05-05	5/16	7.9	05	1/2-20	17	17	11
0900-05-06	5/16	7.9	05	9/16-18	19	16	9
0900-06-05	3/8	9.5	06	1/2-20	17	15	9.5
0900-06-06	3/8	9.5	06	9/16-18	19	16	9
0900-06-07	3/8	9.5	06	5/8-18	22	16	11
0900-06-08	3/8	9.5	06	3/4-16	24	17	10.5
0900-06-10	3/8	9.5	06	7/8-14	27	21	13
0900-08-08	1/2	12.7	08	3/4-16	24	18	10.5
0900-08-10	1/2	12.7	08	7/8-14	27	19	13
0900-08-12	1/2	12.7	08	1.1/16-12	32	21	13.5
0900-10-10	5/8	15.9	10	7/8-14	27	19	13
0900-10-12	5/8	15.9	10	1.1/16-12	32	21	13.5
0900-12-10	3/4	19	12	7/8-14	27	20	13
0900-12-12	3/4	19	12	1.1/16-12	32	22	13.5
0900-12-14	3/4	19	12	1.3/16-12	36	23	14
0900-12-16	3/4	19	12	1.5/16-12	41	23	15.5
0900-16-12	1	25.4	16	1.1/16-12	32	23	13.5
0900-16-14	1	25.4	16	1.3/16-12	36	24	14
0900-16-16	1	25.4	16	1.5/16-12	41	24	15.5
0900-16-20	1	25.4	16	1.5/8-12	50	27	16.5
0900-20-20	1.1/4	31.8	20	1.5/8-12	50	28	16.5
0900-20-24	1.1/4	31.8	20	1.7/8-12	55	31	19
0900-24-24	1.1/2	38.1	24	1.7/8-12	55	31	19
0900-32-32	2	50.8	32	2.1/2-12	70	31	20

0902

JIC Female 74° - Slip on nut

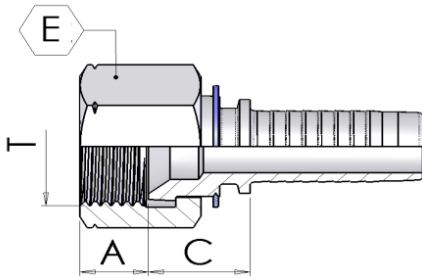

Part number	Hose I.D.		Dimensions				
	in	mm	Dash size	Thread T	Hex E	Cut-Off C	A
0902-04-05	1/4	6.4	04	1/2-20	17	17	9.5
0902-04-06	1/4	6.4	04	9/16-18	19	17	9
0902-05-06	5/16	7.9	05	9/16-18	19	16	9
0902-06-08	3/8	9.5	06	3/4-16	22	18	10.5
0902-08-10	1/2	12.7	08	7/8-14	27	20	13
0902-10-12	5/8	15.9	10	1.1/16-12	32	20	13.5
0902-12-16	3/4	19	12	1.5/16-12	38	21	15.5

0901D

JIC Female 74° Cone- Double Hexagon

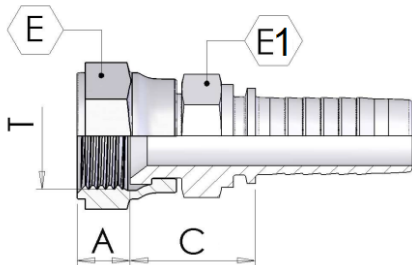

Part number	Hose I.D.		Dimensions					
	in	mm	Dash size	Thread T	Hex E	A	C	E1
0901D04-04	1/4	6.4	04	7/16-20	15	8.5	20	12
0901D04-05	1/4	6.4	04	1/2-20	17	9.5	20	14
0901D04-06	1/4	6.4	04	9/16-18	19	9	22	14
0901D05-06	5/16	7.9	05	9/16-18	19	9	22	15
0901D06-06	3/8	9.5	06	9/16-18	19	9	24	17
0901D06-08	3/8	9.5	06	3/4-16	24	10.5	26	19
0901D08-08	1/2	12.7	08	3/4-16	24	10.5	26	22
0901D08-10	1/2	12.7	08	7/8-14	27	13	27	22
0901D10-10	5/8	15.9	10	7/8-14	27	13	26	22
0901D10-12	5/8	15.9	10	1.1/16-12	32	13.5	27	27
0901D12-12	3/4	19	12	1.1/16-12	32	13.5	32	27
0901D16-16	1	25.4	16	1.5/16-12	38	15.5	33	36

0951

JIC 90° Swept Elbow 74° Cone-Rolled Nut

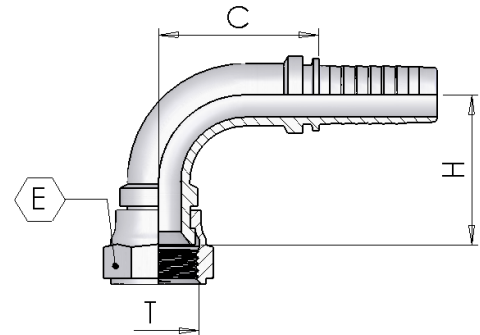

Part number	Hose I.D.		Dimensions				
	in	mm	Dash size	Thread T	Hex E	C	H
0951-03-04	3/16	4.8	03	7/16-20	15	22	22
0951-03-05	3/16	4.8	03	1/2-20	17	22	22
0951-04-04	1/4	6.4	04	7/16-20	15	25	24
0951-04-05	1/4	6.4	04	1/2-20	17	25	25
0951-04-06	1/4	6.4	04	9/16-18	19	25	27
0951-05-05	5/16	7.9	05	1/2-20	17	29	30
0951-05-06	5/16	7.9	05	9/16-18	19	29	31
0951-06-05	3/8	9.5	06	1/2-20	17	33	30
0951-06-06	3/8	9.5	06	9/16-18	19	31	32
*SAE 45° 0951-06-07	3/8	9.5	06	5/8-18	22	33	32
0951-06-08	3/8	9.5	06	3/4-16	24	33	34
0951-06-10	3/8	9.5	06	7/8-14	27	33	36
0951-08-08	1/2	12.7	08	3/4-16	24	41	41
0951-08-10	1/2	12.7	08	7/8-14	27	41	40
0951-08-12	1/2	12.7	08	1.1/16-12	32	39	43
0951-10-10	5/8	15.9	10	7/8-14	27	43	44
0951-10-12	5/8	15.9	10	1.1/16-12	32	45	47
Welded 0951-12-10	3/4	19	12	7/8-14	27	56	53
0951-12-12	3/4	19	12	1.1/16-12	32	56	54
0951-12-14	3/4	19	12	1.3/16-12	36	57	53
0951-12-16	3/4	19	12	1.5/16-12	38	55	56
0951-16-12	1	25.4	16	1.1/16-12	32	70	63
0951-16-16	1	25.4	16	1.5/16-12	38	70	65

0950

JIC 90° Swept Elbow 74° Cone - Thrust Wire Nut

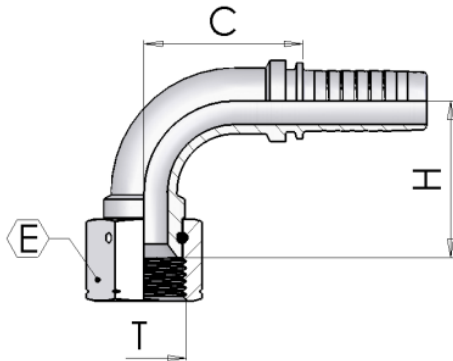

Part number	Hose I.D.		Dimensions				
	in	mm	Dash size	Thread T	Hex E	C	H
0950-03-04	3/16	4.8	03	7/16-20	17	22	22
0950-04-04	1/4	6.4	04	7/16-20	17	25	24
0950-04-05	1/4	6.4	04	1/2-20	17	25	25
0950-04-06	1/4	6.4	04	9/16-18	19	25	27
0950-05-06	5/8	7.9	05	9/16-18	19	29	31
0950-05-08	5/8	7.9	05	3/4-16	24	29	41
0950-06-05	3/8	9.5	06	1/2-20	17	33	30
0950-06-06	3/8	9.5	06	9/16-18	19	31	32
0950-06-10	3/8	9.5	06	7/8-14	27	33	36
0950-08-08	1/2	12.7	08	3/4-16	24	41	41
0950-08-10	1/2	12.7	08	7/8-14	27	41	40
0950-08-12	1/2	12.7	08	1.1/16-12	32	39	43
0950-10-10	5/8	15.9	10	7/8-14	27	43	44
0950-10-12	5/8	15.9	10	1.1/16-12	32	45	47
Welded 0950-12-10	3/4	19	12	7/8-14	27	56	53
0950-12-12	3/4	19	12	1.1/16-12	32	56	54
0950-12-14	3/4	19	12	1.3/16-12	36	57	53
0950-12-16	3/4	19	12	1.5/16-12	41	55	56
0950-16-12	1	25.4	16	1.1/16-12	32	70	63
Welded 0950S16-14	1	25.4	16	1.3/16-12	36	62	69
0950-16-16	1	25.4	16	1.5/16-12	41	70	65
Welded 0950S16-20	1	25.4	16	1.5/8-12	50	62	69
0950-20-20	1.1/4	31.8	20	1.5/8-12	50	87	83
Welded 0950S20-24	1.1/4	31.8	24	1.7/8-12	55	81	88
0950-24-24	1.1/2	38.1	24	1.7/8-12	55	102	97
0950-32-32	2	50.8	32	2.1/2-12	70	121	134

0952

JIC 90° Swept Elbow 74° Cone - Slip on nut

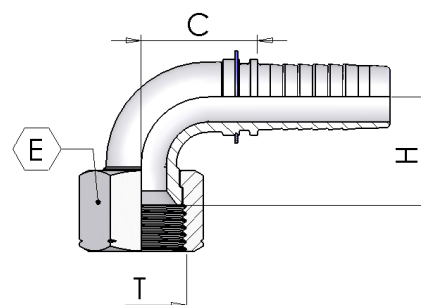

Part number	Hose I.D.		Dimensions				
	in	mm	Dash size	Thread T	Hex E	C	H
0952-04-05	1/4	6.4	04	1/2-20	17	27	21
0952-04-06	1/4	6.4	04	9/16-18	19	26	21
0952-05-06	5/8	7.9	05	9/16-18	19	25	32
0952-06-08	3/8	9.5	06	3/4-16	22	35	26
0952-08-10	1/2	12.7	08	7/8-14	27	40	32
0952-10-12	5/8	15.9	10	1.1/16-12	32	47	37
0952-12-12	3/4	19	12	1.1/16-12	32	58	45
0952-12-16	3/4	19	12	1.5/16-12	38	56	57

2970

JIC 90° Compact Elbow 74° Cone - Thrust Wire Nut

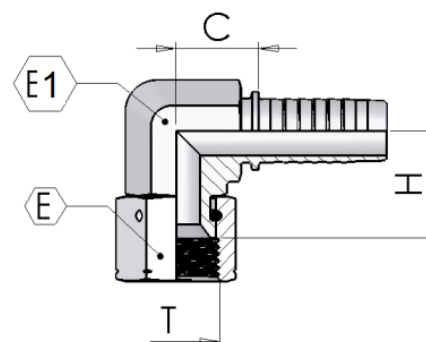

Part number	Hose I.D.		Dimensions					
	in	mm	Dash size	Thread T	Hex E	C	H	E1
2970-04-04	1/4	6.4	04	7/16-20	17	19	17	15
2970-04-05	1/4	6.4	04	1/2-20	17	19	18	15
2970-04-06	1/4	6.4	04	9/16-18	19	19	19	15
2970-05-06	5/16	7.9	05	9/16-18	19	20	20	17
2970-06-06	3/8	9.5	06	9/16-18	19	23	20	17
*SAE 45° 2970-06-07	3/8	9.5	06	5/8-18	22	23	21	17
2970-06-08	3/8	9.5	06	3/4-16	24	24	22	22
2970-08-08	1/2	12.7	08	3/4-16	24	26	23	22
2970-08-10	1/2	12.7	08	7/8-14	27	26	24	22
2970-12-12	3/4	19	12	1.1/16-12	32	32	29	27
2970-16-16	1	25.4	16	1.5/16-12	41	38	34	32

*SAE 45°

2971

JIC 90° Compact Elbow 74° Cone-Crimped Nut

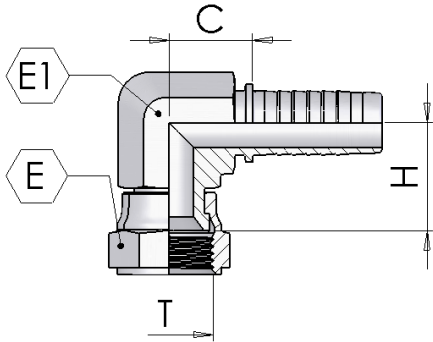

Part number	Hose I.D.		Dimensions					
	in	mm	Dash size	Thread T	Hex E	C	H	E1
2971-04-04	1/4	6.4	04	7/16-20	15	19	17	15
2971-04-05	1/4	6.4	04	1/2-20	17	19	18	15
2971-04-06	1/4	6.4	04	9/16-18	19	19	19	15
2971-05-06	5/16	7.9	05	9/16-18	19	20	20	17
2971-06-06	3/8	9.5	06	9/16-18	19	23	20	17
2971-06-08	3/8	9.5	06	3/4-16	24	24	22	22

2950

JIC 90° Compact Elbow 74° Cone-Thrust Wire Nut-Welded

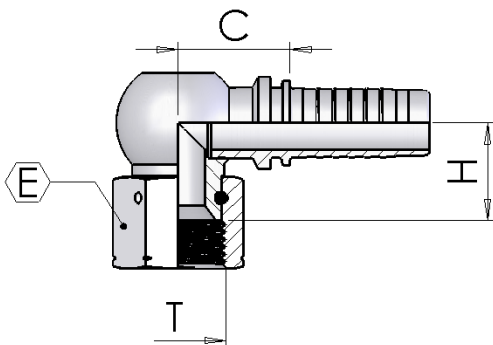

Part number	Hose I.D.		Dimensions				
	in	mm	Dash size	Thread T	Hex E	C	H
2950-10-10	5/8	15.9	10	7/8-14	27	28	26
2950-10-12	5/8	15.9	10	1.1/16-12	32	29	28

2951

JIC 90° Compact Elbow 74° Cone- Rolled Nut - Welded

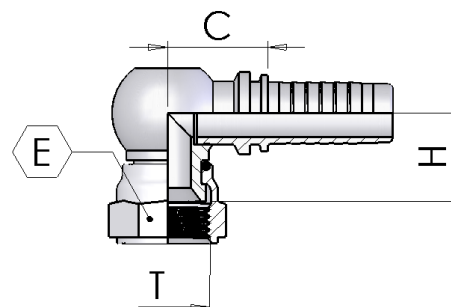

Part number	Hose I.D.		Dimensions				
	in	mm	Dash size	Thread T	Hex E	C	H
2951-10-10	5/8	15.9	10	7/8-14	27	28	26
2951-10-12	5/8	15.9	10	1.1/16-12	32	29	28

1001

JIC 90° Swept Elbow 74° Cone - Rolled Nut

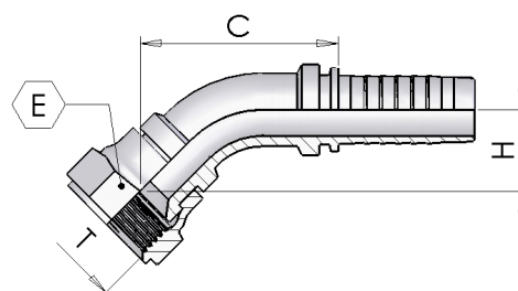

Part number	Hose I.D.		Dimensions				
	in	mm	Dash size	Thread T	Hex E	C	H
1001-03-04	3/16	4.8	03	7/16-20	15	33	15
1001-04-04	1/4	6.4	04	7/16-20	15	38	13
1001-04-05	1/4	6.4	04	1/2-20	17	40	14
1001-04-06	1/4	6.4	04	9/16-18	19	47	18
1001-05-05	5/16	7.9	05	1/2-20	17	16	17
1001-05-06	5/16	7.9	05	9/16-18	19	47	18
1001-06-05	3/8	9.5	06	1/2-20	17	51	17
1001-06-06	3/8	9.5	06	9/16-18	19	51	17
*SAE 45° 1001-06-07	3/8	9.5	06	5/8-18	22	51	17
1001-06-08	3/8	9.5	06	3/4-16	24	52	19
1001-06-10	3/8	9.5	06	7/8-14	27	54	21
1001-08-08	1/2	12.7	08	3/4-16	24	62	22
1001-08-10	1/2	12.7	08	7/8-14	27	64	23
1001-08-12	1/2	12.7	08	1.1/16-12	32	68	25
1001-10-10	5/8	15.9	10	7/8-14	27	68	24
1001-10-12	5/8	15.9	10	1.1/16-12	32	70	25
Welded 1001S12-10	3/4	19	12	7/8-14	27	83	27
1001-12-12	3/4	19	12	1.1/16-12	32	84	28
1001-12-14	3/4	19	12	1.3/16-12	36	84	29
1001-12-16	3/4	19	12	1.5/16-12	38	88	30
1001-16-16	1	25.4	16	1.5/16-12	38	104	33

1002

JIC 45° Swept Elbow 74° Cone - Slipe on nut

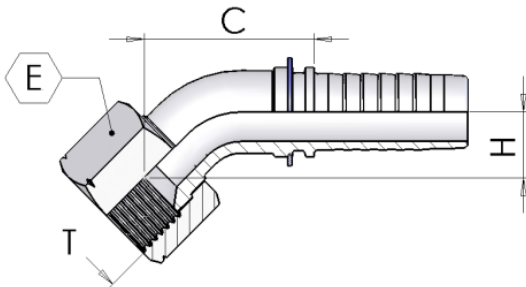

Part number	Hose I.D.		Dimensions				
	in	mm	Dash size	Thread T	Hex E	C	H
1002-04-05	1/4	6.4	04	1/2-20	17	38	11
1002-04-06	1/4	6.4	04	9/16-18	19	38	11
1002-05-06	5/16	7.9	05	9/16-18	19	49	20
1002-06-08	3/8	9.5	06	3/4-16	22	48	13
1002-08-10	1/2	12.7	08	7/8-14	27	58	16
1002-10-12	5/8	15.9	10	1.1/16-12	32	66	18
1002-12-12	3/4	19	12	1.1/16-12	32	81	21
1002-12-16	3/4	19	12	1.5/16-12	38	86	30

0385

SAE Male O'R Flat Seat

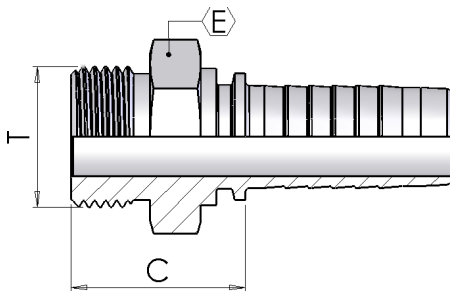

Part number	Hose I.D.		Dimensions			
	in	mm	Dash size	Thread T	Hex E	Cut-Off C
0385-04-04	1/4	6.4	04	7/16-20	14	24
0385-04-06	1/4	6.4	04	9/16-18	17	24
0385-05-06	5/16	7.9	05	9/16-18	17	24
0385-06-06	3/8	9.5	06	9/16-18	17	25
0385-06-08	3/8	9.5	06	3/4-16	22	28
0385-08-08	1/2	12.7	08	3/4-16	22	28
0385-08-10	1/2	12.7	08	7/8-14	27	30
0385-08-12	1/2	12.7	08	1.1/16-12	32	32
0385-10-10	5/8	15.9	10	7/8-14	27	30
0385-10-12	5/8	15.9	10	1.1/16-12	32	32
0385-12-12	3/4	19	12	1.1/16-12	32	33

0390

Swivel Male O'Ring

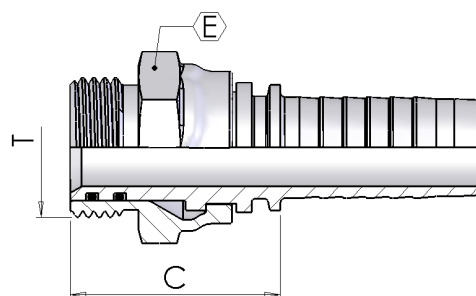

Part number	Hose I.D.		Dimensions			
	in	mm	Dash size	Thread T	Hex E	Cut-Off C
0390-08-10	1/2	12.7	08	7/8-14	27	39
0390-10-10	5/8	15.9	10	7/8-14	27	39
0390-12-12	3/4	19	12	1.1/16-12	32	43

0395

90° Swivel Male O'ring

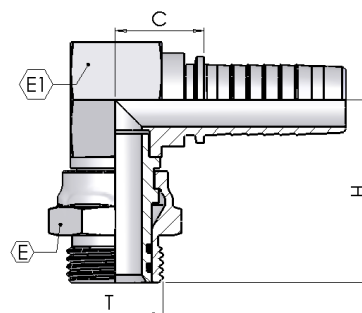

Part number	Hose I.D.		Dimensions					
	in	mm	Dash size	Thread T	Hex E	Cut-Off C	H	E1
0395-08-10	1/2	12.7	08	7/8-14	27	21	48	27
0395-10-10	5/8	15.9	10	7/8-14	27	21	48	27
0395-12-12	3/4	19	12	1.1/16-12	32	25	52	32

IF00

Straight Male Inverted Flare Swivel

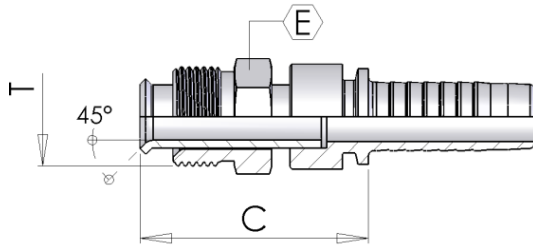

Part number	Hose I.D.		Dimensions			
	in	mm	Dash size	Thread T	Hex E	Cut-Off C
IF00-04-04	1/4	6.4	04	7/16-24	12	38
IF00-04-05	1/4	6.4	04	1/2-20	14	55
IF00-05-04	5/8	7.9	05	7/16-24	12	56
IF00-05-05	5/8	7.9	05	1/2-20	14	56
IF00-05-07	5/8	7.9	05	5/8-18	17	56
IF00-06-04	3/8	9.5	06	7/16-24	12	56
IF00-06-05	3/8	9.5	06	1/2-20	14	56
IF00-06-07	3/8	9.5	06	5/8-18	17	57
IF00-06-09	3/8	9.5	06	11/16-18	19	42
IF00-08-08	1/2	12.7	08	3/4-18	19	60

IF90

90° Male Inverted Flare Swivel

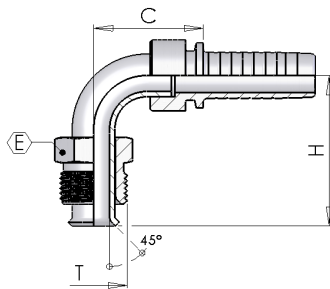

Part number	Hose I.D.		Dimensions				
	in	mm	Dash size	Thread T	Hex E	Cut-Off C	H
IF90-04-04	1/4	6.4	04	7/16-24	12	29	36
IF90-04-05	1/4	6.4	04	1/2-20	14	30	34
IF90-05-04	5/8	7.9	05	7/16-24	12	24	38
IF90-05-05	5/8	7.9	05	1/2-20	14	30	35
IF90-05-07	5/8	7.9	05	5/8-18	17	30	43
IF90-06-04	3/8	9.5	06	7/16-24	12	30	35
IF90-06-05	3/8	9.5	06	1/2-20	14	30	35
IF90-06-07	3/8	9.5	06	5/8-18	17	31	44
IF90-06-09	3/8	9.5	06	11/16-18	19	31	42
IF90-08-08	1/2	12.7	08	3/4-18	19	35	45

IF45

45° Male Inverted Flare Swivel

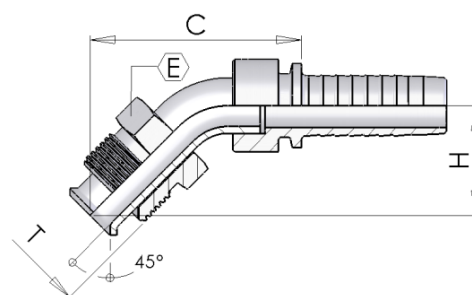

Part number	Hose I.D.		Dimensions				
	in	mm	Dash size	Thread T	Hex E	Cut-Off C	H
IF45-06-04	3/8	9.5	06	7/16-24	12	48	25
IF45-06-05	3/8	9.5	06	1/2-20	14	48	25
IF45-06-07	3/8	9.5	06	5/8-18	17	54	30
IF45-06-09	3/8	9.5	06	11/16-18	19	54	30

0400

Metric Male 60° Cone

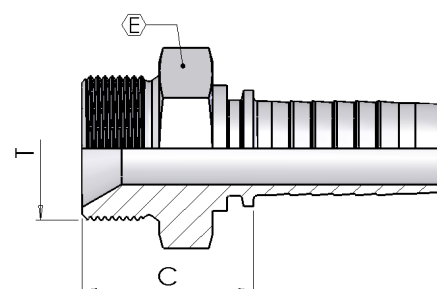

Part number	Hose I.D.		Dimensions			
	in	mm	Dash size	Thread T	Hex E	Cut-Off C
0400-03-10	3/16	4.8	03	M10-1	14	19
0400-03-12	3/16	4.8	03	M12-1.5	17	25
0400-04-10	1/4	6.4	04	M10-1	14	20
0400-04-12	1/4	6.4	04	M12-1.5	17	26
0400-04-14	1/4	6.4	04	M14-1.5	19	26
0400-04-16	1/4	6.4	04	M16-1.5	22	26
0400-05-12	5/16	7.9	05	M12-1.5	17	26
0400-05-16	5/16	7.9	05	M16-1.5	22	26
0400-05-18	5/16	7.9	05	M18-1.5	24	26
0400-06-14	3/8	9.5	06	M14-1.5	19	26
0400-06-16	3/8	9.5	06	M16-1.5	22	26
0400-06-18	3/8	9.5	06	M18-1.5	24	27
0400-06-22	3/8	9.5	06	M22-1.5	27	27
0400-08-18	1/2	12.7	08	M18-1.5	24	28
0400-08-22	1/2	12.7	08	M22-1.5	27	30
0400-10-26	5/8	15.9	10	M26-1.5	32	32
0400-12-26	3/4	19	12	M26-1.5	32	33
0400-12-30	3/4	19	12	M30-1.5	36	36
0400-16-38	1	25.4	16	M38-1.5	46	37
0400-20-45	1.1/4	31.8	20	M45-1.5	55	39

0100

Metric Female 60° Cone

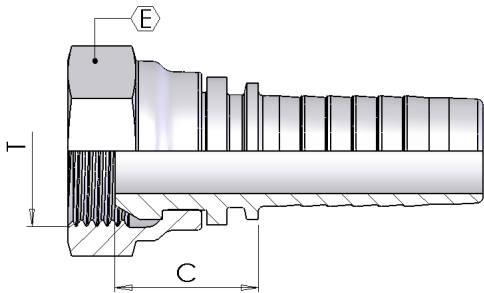

Part number	Hose I.D.		Dimensions			
	in	mm	Dash size	Thread T	Hex E	Cut-Off C
0100-12-30	3/4	19	12	M30-1.5	36	23
0100-16-38	1	25.4	16	M38-1.5	46	33
0100-20-45	1.1/4	31.8	20	M45-1.5	50	34
0100-24-52	1.1/2	38	24	M52x1,5	60	35
0100-32-65	2	50.8	32	M65-2	75	31

0200

90° Metric Swept Elbow 60° Cone

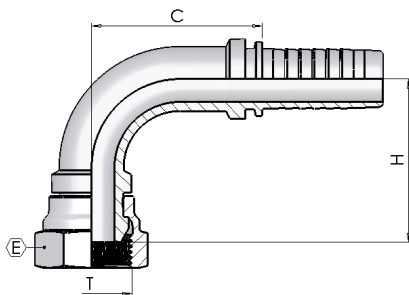

	Part number	Hose I.D.		Dimensions				
		in	mm	Dash size	Thread T	Hex E	Cut-Off C	H
Welded	0200S12-30	3/4	19	12	M30-1.5	36	48	57
Welded	0200S20-45	1.1/4	31.8	20	M45-1.5	50	63	71
	0200-16-38	1	25.4	16	M38-1.5	46	70	71

0300

45° Metric Swept Elbow 60° Cone

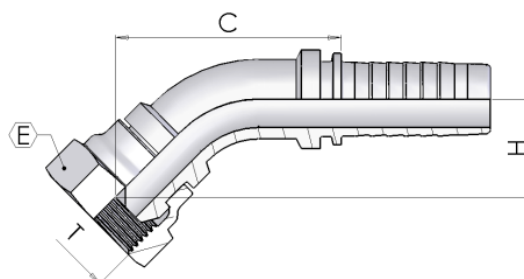

	Part number	Hose I.D.		Dimensions				
		in	mm	Dash size	Thread T	Hex E	Cut-Off C	H
Welded	0300S12-30	3/4	19	12	M30-1.5	36	57	27
Welded	0300S20-45	1.1/4	31.8	20	M45-1.5	50	73	27
	0300-16-38	1	25.4	16	M38-1.5	46	109	38

0035

Metric Female 24° - Seat Light Multiseal

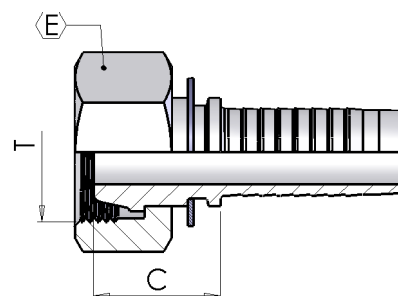

Part number	Hose I.D.		Dimensions				
	in	mm	Dash size	Thread T	Erm	Hex E	Cut-Off C
0035-03-12	3/16	4.8	03	M12-1.5	6	14	19
0035-03-16	3/16	4.8	03	M16-1.5	10	19	18
0035-04-14	1/4	6.4	04	M14-1.5	8	17	19
0035-04-16	1/4	6.4	04	M16-1.5	10	19	19
0035-05-16	5/16	7.9	05	M16-1.5	10	19	19
0035-05-18	5/16	7.9	05	M18-1.5	12	22	21
0035-06-18	3/8	9.5	06	M18-1.5	12	22	23
0035-06-22	3/8	9.5	06	M22-1.5	15	27	22
0035-08-22	1/2	12.7	08	M22-1.5	15	27	22
0035-08-26	1/2	12.7	08	M26-1.5	18	32	24
0035-10-26	5/8	15.9	10	M26-1.5	18	32	24

0135

90° Metric Swept Elbow 24° - Seat Light Multiseal

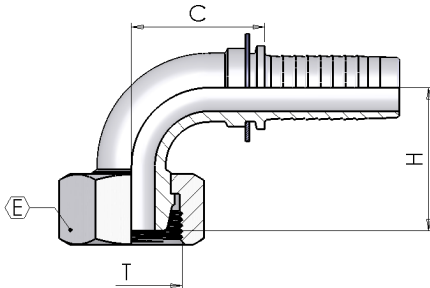

Part number	Hose I.D.		Dimensions					
	in	mm	Dash size	Thread T	Erm	Hex E	Cut-Off C	H
0135-04-14	1/4	6.4	04	M14-1.5	8	17	25	25
0135-04-16	1/4	6.4	04	M16-1.5	10	19	26	24
0135-05-16	5/16	7.9	05	M16-1.5	10	19	32	29
0135-05-18	5/16	7.9	05	M18-1.5	12	22	31	30
0135-06-18	3/8	9.5	06	M18-1.5	12	22	32	33
0135-06-22	3/8	9.5	06	M22-1.5	15	27	33	34
0135-08-22	1/2	12.7	08	M22-1.5	15	27	41	38
0135-10-26	5/8	15.9	10	M26-1.5	18	32	46	42

0235

45° Metric Swept Elbow 24° - Seat Light Multiseal

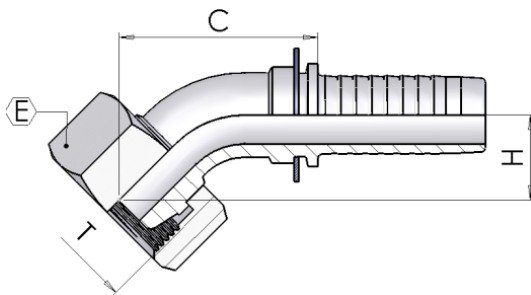

Part number	Hose I.D.		Dimensions					
	in	mm	Dash size	Thread T	Erm	Hex E	Cut-Off C	H
0235-04-12	1/4	6.4	04	M12-1.5	6	14	36	15
0235-04-14	1/4	6.4	04	M14-1.5	8	17	40	14
0235-04-16	1/4	6.4	04	M16-1.5	10	19	37	16
0235-05-16	5/16	7.9	05	M16-1.5	10	19	47	14
0235-05-18	5/16	7.9	05	M18-1.5	12	22	49	16
0235-06-18	3/8	9.5	06	M18-1.5	12	22	50	16
0235-08-22	1/2	12.7	08	M22-1.5	15	27	61	21

Metric Male 24° - Seat Light

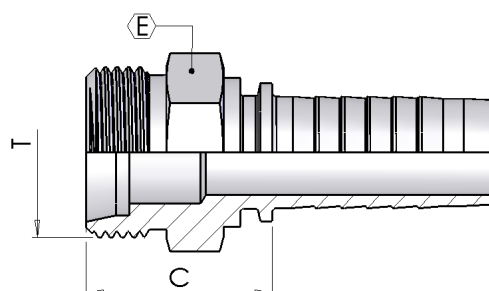

Part number	Hose I.D.		Dimensions				
	in	mm	Dash size	Thread T	Erm	Hex E	Cut-Off C
0500-03-12	3/16	4.8	03	M12-1.5	6	14	22
0500-04-12	1/4	6.4	04	M12-1.5	6	14	23
0500-04-14	1/4	6.4	04	M14-1.5	8	14	22
0500-04-16	1/4	6.4	04	M16-1.5	10	17	23
0500-04-18	1/4	6.4	04	M18-1.5	12	19	24
0500-05-14	5/16	7.9	05	M14-1.5	8	14	22
0500-05-16	5/16	7.9	05	M16-1.5	10	17	23
0500-05-18	5/16	7.9	05	M18-1.5	12	19	24
0500-05-22	5/16	7.9	05	M22-1.5	15	22	25
0500-06-16	3/8	9.5	06	M16-1.5	10	17	23
0500-06-18	3/8	9.5	06	M18-1.5	12	19	24
0500-06-22	3/8	9.5	06	M22-1.5	15	22	25
0500-08-18	1/2	12.7	08	M18-1.5	12	19	25
0500-08-22	1/2	12.7	08	M22-1.5	15	22	26
0500-08-26	1/2	12.7	08	M26-1.5	18	27	27
0500-10-22	5/8	15.9	10	M22-1.5	15	22	26
0500-10-26	5/8	15.9	10	M26-1.5	18	27	27
0500-10-30	5/8	15.9	10	M30-2	22	30	32
0500-12-26	3/4	19	12	M26-1.5	18	27	28
0500-12-30	3/4	19	12	M30-2	22	30	33
0500-16-36	1	25.4	16	M36-2	28	36	32
0500-20-45	1.1/4	31.8	20	M45-2	35	46	36
0500-24-52	1.1/2	38.1	24	M52-2	42	55	38

0085

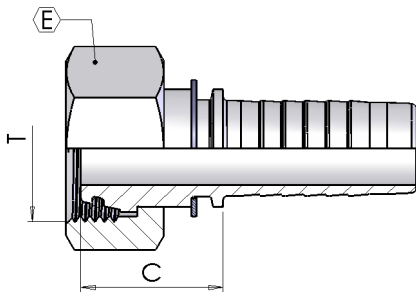

Metric Female 24° - Seat Light

Part number	Hose I.D.		Dimensions				
	in	mm	Dash size	Thread T	Erm	Hex E	Cut-Off C
0085-03-12	3/16	4.8	03	M12-1.5	6	14	23
0085-04-14	1/4	6.4	04	M14-1.5	8	17	24
0085-04-16	1/4	6.4	04	M16-1.5	10	19	24
0085-04-18	1/4	6.4	04	M18-1.5	12	22	25
0085-05-16	5/16	7.9	05	M16-1.5	10	19	24
0085-05-18	5/16	7.9	05	M18-1.5	12	22	25
0085-06-18	3/8	9.5	06	M18-1.5	12	22	25
0085-06-22	3/8	9.5	06	M22-1.5	15	27	29
0085-08-22	1/2	12.7	08	M22-1.5	15	27	29
0085-08-26	1/2	12.7	08	M26-1.5	18	32	29
0085-10-26	5/8	15.9	10	M26-1.5	18	32	29
0085-10-30	5/8	15.9	12	M30-2	22	36	29
0085-12-30	3/4	19	12	M30-2	22	36	29
0085-12-36	3/4	19	12	M36-2	28	41	28
0085-16-36	1	25.4	16	M36-2	28	41	30
0085-20-45	1.1/4	31.8	20	M45-2	35	50	40
0085-24-52	1.1/2	38.1	24	M52-2	42	60	41

0085

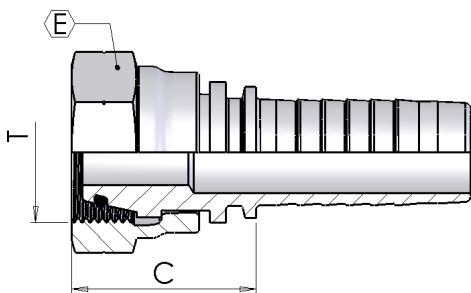

Metric Female 24° - Seat Light (Rolled Nut)

Part number	Hose I.D.		Dimensions				
	in	mm	Dash size	Thread T	Erm	Hex E	Cut-Off C
0085-04-12	1/4	6.4	04	M12-1.5	6	14	25
0085-05-14	5/16	7.9	05	M14-1.5	8	19	26
0085-06-16	3/8	9.5	06	M16-1.5	10	19	25
0085-08-18	1/2	12.7	08	M18-1.5	12	24	28
0085-10-22	5/8	15.9	10	M22-1.5	15	27	32
0085-12-26	3/4	19	12	M26-1.5	18	32	36

90° Metric Swept Elbow 24° - Seat Light

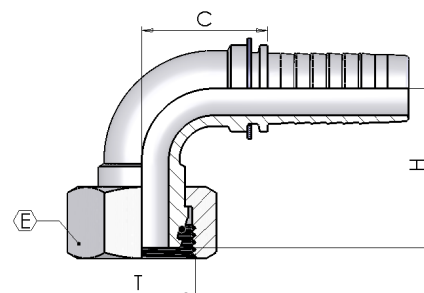

Part number	Hose I.D.		Dimensions					
	in	mm	Dash size	Thread T	Erm	Hex E	Cut-Off C	H
0185-03-12	3/16	4.8	03	M12-1.5	6	14	22	23
0185-04-14	1/4	6.4	04	M14-1.5	8	17	26	26
0185-04-16	1/4	6.4	04	M16-1.5	10	19	25	27
0185-04-18	1/4	6.4	04	M18-1.5	12	22	27	30
0185-05-16	5/16	7.9	05	M16-1.5	10	19	31	31
0185-05-18	5/16	7.9	05	M18-1.5	12	22	31	32
0185-06-18	3/8	9.5	06	M18-1.5	12	22	32	35
0185-06-22	3/8	9.5	06	M22-1.5	15	27	32	35
0185-08-22	1/2	12.7	08	M22-1.5	15	27	41	38
Welded 0185-08-26	1/2	12.7	08	M26-1.5	18	32	41	39
0185-10-26	5/8	15.9	10	M26-1.5	18	32	44	44
Welded 0185S12-26	3/4	19	12	M26-1.5	18	32	42	44
0185-12-30	3/4	19	12	M30-2	22	36	58	52
Welded 0185S12-36	3/4	19	12	M36-2	28	41	49	51
0185-16-36	1	25.4	16	M36-2	28	41	72	62
Welded 0185S20-45	1.1/4	31.8	20	M45-2	35	50	63	73
Welded 0185S24-52	1.1/2	38.1	24	M52-2	42	60	81	83

0185

90° Metric Swept Elbow 24° - Seat Light (Rolled Nut)

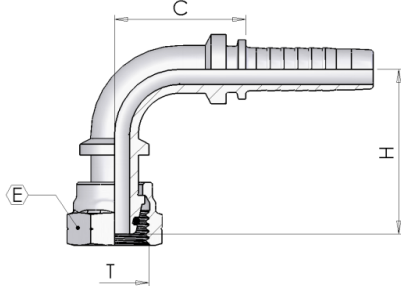

Part number	Hose I.D.		Dimensions					
	in	mm	Dash size	Thread T	Erm	Hex E	Cut-Off C	H
0185-04-12	1/4	6.4	04	M12-1.5	6	14	26	34
0185-05-14	5/16	7.9	05	M14-1.5	8	17	30	38
0185-06-16	3/8	9.5	06	M16-1.5	10	19	32	39
Welded 0185S08-18	1/2	12.7	08	M18-1.5	12	24	33	48
0185-10-22	5/8	15.9	08	M22-1.5	15	27	42	55

0285

45° Metric Swept Elbow 24° - Seat Light

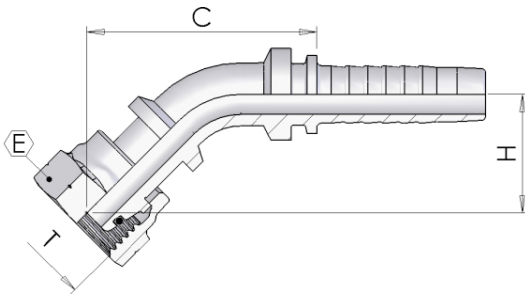

Part number	Hose I.D.		Dimensions					
	in	mm	Dash size	Thread T	Erm	Hex E	Cut-Off C	H
0285-03-12	3/16	4.8	03	M12-1.5	6	14	36	14
0285-04-14	1/4	6.4	04	M14-1.5	8	17	42	14
0285-04-16	1/4	6.4	04	M16-1.5	10	19	42	15
0285-04-18	1/4	6.4	04	M18-1.5	12	22	43	16
0285-05-16	5/16	7.9	05	M16-1.5	10	19	48	17
0285-05-18	5/16	7.9	05	M18-1.5	12	22	48	18
0285-06-18	3/8	9.5	06	M18-1.5	12	22	52	19
0285-06-22	3/8	9.5	06	M22-1.5	15	27	51	19
0285-08-22	1/2	12.7	08	M22-1.5	15	27	63	21
Welded 0285S08-26	1/2	12.7	08	M26-1.5	18	32	44	17
0285-10-26	5/8	15.9	10	M26-1.5	18	32	68	23
Welded 0285S12-26	3/4	19	12	M26-1.5	18	32	43	19
0285-12-30	3/4	19	12	M30-2	22	36	85	27
0285-16-36	1	25.4	16	M36-2	28	41	102	32
Welded 0285S20-45	1.1/4	31.8	20	M45-2	35	50	72	34
Welded 0285S24-52	1.1/2	38.1	24	M52-2	42	60	85	36

0285

45° Metric Swept Elbow 24° Seat Light (Rolled Nut)

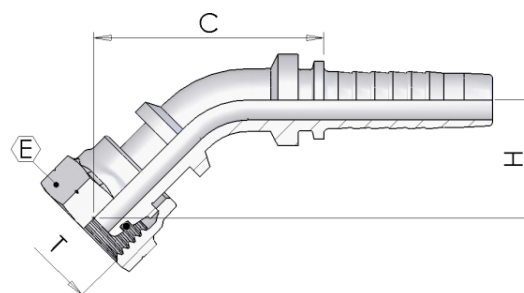

Part number	Hose I.D.		Dimensions					
	in	mm	Dash size	Thread T	Erm	Hex E	Cut-Off C	H
0285-04-12	1/4	6.4	04	M12-1.5	6	14	46	20
0285-06-16	3/8	9.5	06	M16-1.5	10	19	55	22

0450

Metric Male 24° -Seat Heavy

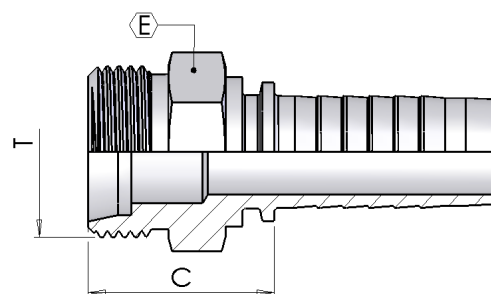

Part number	Hose I.D.		Dimensions				
	in	mm	Dash size	Thread T	Erm	Hex E	Cut-Off C
0450-03-16	3/16	4.8	03	M16-1.5	8	17	26
0450-04-14	1/4	6.4	04	M14-1.5	6	14	25
0450-04-16	1/4	6.4	04	M16-1.5	8	17	27
0450-04-18	1/4	6.4	04	M18-1.5	10	19	27
0450-05-18	5/16	7.9	05	M18-1.5	10	19	27
0450-05-20	5/16	7.9	05	M20-1.5	12	22	29
0450-06-18	3/8	9.5	06	M18-1.5	10	19	27
0450-06-20	3/8	9.5	06	M20-1.5	12	22	29
0450-06-22	3/8	9.5	06	M22-1.5	14	22	31
0450-06-24	3/8	9.5	06	M24-1.5	16	24	31
0450-08-24	1/2	12.7	08	M24-1.5	16	24	32
0450-10-30	5/8	15.9	10	M30-2	20	30	34
0450-12-30	3/4	19	12	M30-2	20	30	35
0450-12-36	3/4	19	12	M36-2	25	36	38
0450-16-36	1	25.4	16	M36-2	25	36	39
0450-16-42	1	25.4	16	M42-2	30	46	42
0450-20-42	1.1/4	31.8	20	M42-2	30	46	43
0450-20-52	1.1/4	31.8	20	M52-2	38	55	45
0450-24-52	1.1/2	38.1	24	M52-2	38	55	45

0084

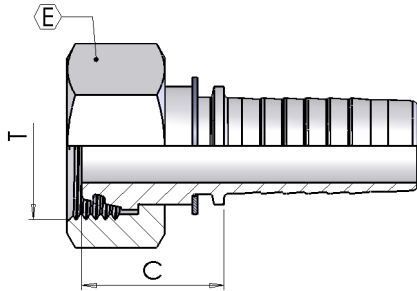

Metric Female 24° - Seat Heavy

Part number	Hose I.D.		Dimensions				
	in	mm	Dash size	Thread T	Erm	Hex E	Cut-Off C
0084-03-16	3/16	4.8	03	M16-1.5	8	19	25
0084-04-14	1/4	6.4	04	M14-1.5	6	17	23
0084-04-16	1/4	6.4	04	M16-1.5	8	19	25
0084-04-18	1/4	6.4	04	M18-1.5	10	22	24
0084-05-18	5/16	7.9	05	M18-1.5	10	22	24
0084-05-20	5/16	7.9	05	M20-1.5	12	24	26
0084-06-18	3/8	9.5	06	M18-1.5	10	22	25
0084-06-20	3/8	9.5	06	M20-1.5	12	24	25
0084-06-22	3/8	9.5	06	M22-1.5	14	27	29
0084-08-22	1/2	12.7	08	M22-1.5	14	27	17
0084-08-24	1/2	12.7	08	M24-1.5	16	30	30
0084-08-30	1/2	12.7	08	M30-2	20	36	33
0084-10-30	5/8	15.9	10	M30-2	20	36	33
0084-12-30	3/4	19	12	M30-2	20	36	34
0084-12-36	3/4	19	12	M36-2	25	46	40
0084-16-36	1	25.4	16	M36-2	25	46	41
0084-16-42	1	25.4	16	M42-2	30	50	43
0084-20-52	1.1/4	31.8	20	M52-2	38	60	44
0084-24-52	1.1/2	38.1	24	M52-2	38	60	44

0184

90° Metric Swept Elbow 24° - Seat Heavy

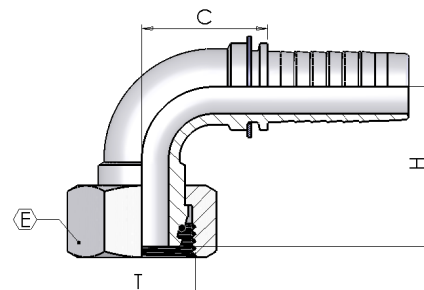

Part number	Hose I.D.		Dimensions					
	in	mm	Dash size	Thread T	Erm	Hex E	Cut-Off C	H
0184-03-16	3/16	4.8	03	M16-1.5	8	19	22	25
0184-04-14	1/4	6.4	04	M14-1.5	6	17	27	26
0184-04-16	1/4	6.4	04	M16-1.5	8	19	26	26
0184-04-18	1/4	6.4	04	M18-1.5	10	22	27	31
0184-04-20	1/4	6.4	04	M20-1.5	12	24	27	30
0184-05-18	5/16	7.9	05	M18-1.5	10	22	33	33
0184-05-20	5/16	7.9	05	M20-1.5	12	24	30	34
0184-06-18	3/8	9.5	06	M18-1.5	10	22	34	35
0184-06-20	3/8	9.5	06	M20-1.5	12	24	34	34
0184-06-22	3/8	9.5	06	M22-1.5	14	27	33	33
0184-08-24	1/2	12.7	08	M24-1.5	16	30	40	41
0184-10-24	5/8	15.9	10	M24-1.5	16	30	42	60
0184-10-30	5/8	15.9	10	M30-2	20	36	46	50
0184-12-30	3/4	19	12	M30-2	20	36	58	56
0184-12-36	3/4	19	12	M36-2	25	46	56	59
0184-16-36	1	25.4	16	M36-2	25	46	69	67
0184-16-42	1	25.4	16	M42-2	30	50	69	67
0184-20-52	1.1/4	31.8	20	M52-2	38	60	84	82
0184-24-52	1.1/2	38.1	24	M52-2	38	60	99	94

0284

45° Metric Swept Elbow 24° - Seat Heavy

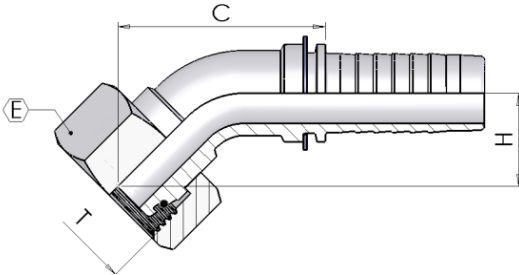

Part number	Hose I.D.		Dimensions					
	in	mm	Dash size	Thread T	Erm	Hex E	Cut-Off C	H
0284-03-16	3/16	4.8	03	M16-1.5	8	19	36	16
0284-04-14	1/4	6.4	04	M14-1.5	6	17	37	15
0284-04-16	1/4	6.4	04	M16-1.5	8	19	42	15
0284-04-18	1/4	6.4	04	M18-1.5	10	22	45	18
0284-05-20	5/16	7.9	05	M20-1.5	12	24	49	19
0284-06-18	3/8	9.5	06	M18-1.5	10	22	51	19
0284-06-20	3/8	9.5	06	M20-1.5	12	24	53	18
0284-06-22	3/8	9.5	06	M22-1.5	14	27	54	20
0284-08-24	1/2	12.7	08	M24-1.5	16	30	63	21
0284-10-30	5/8	15.9	10	M30-2	20	36	74	29
0284-12-30	3/4	19	12	M30-2	20	36	87	30
0284-12-36	3/4	19	12	M36-2	25	46	56	31
0284-16-36	1	25.4	16	M36-2	25	46	105	34
0284-16-42	1	25.4	16	M42-2	30	50	82	33
0284-20-52	1.1/4	31.8	20	M52-2	38	60	105	39
0284-24-52	1.1/2	38.1	24	M52-2	38	60	157	52

1350

Metric Banjo

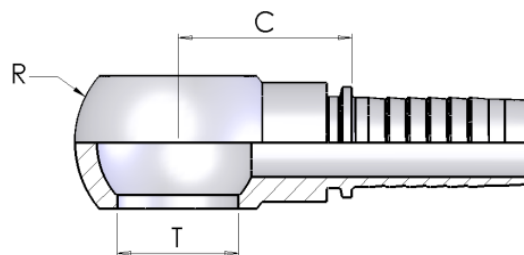

Part number	Hose I.D.		Dimensions				
	in	mm	Dash size	Hole T	mm	Cut-Off C	R
1350-03-10	3/16	4.8	03	M10-1	10.2	25	17
1350-03-12	3/16	4.8	03	M12-1.5	12.2	21	20
1350-04-10	1/4	6.4	04	M10-1	10.2	25	17
1350-04-12	1/4	6.4	04	M12-1.5	12.2	22	20
1350-04-14	1/4	6.4	04	M14-1.5	14.2	25	24
1350-05-14	5/16	7.9	05	M14-1.5	14.2	25	24
1350-05-16	5/16	7.9	05	M16-1.5	16.2	31	28
1350-05-18	5/16	7.9	05	M18-1.5	18.2	29	32
1350-06-14	3/8	9.5	06	M14-1.5	14.2	25	24
1350-06-16	3/8	9.5	06	M16-1.5	16.2	31	28
1350-06-18	3/8	9.5	06	M18-1.5	18.2	29	32
1350-06-22	3/8	9.5	06	M22-1.5	22.2	31	36
1350-08-16	1/2	12.7	08	M16-1.5	16.2	30	28
1350-08-18	1/2	12.7	08	M18-1.5	18.2	29	32
1350-08-22	1/2	12.7	08	M22-1.5	22.2	31	36
1350-10-22	5/8	15.9	10	M22-1.5	22.2	31	36
1350-10-26	5/8	15.9	10	M26-1.5	26.2	38	45
1350-12-22	3/4	19	12	M22-1.5	22.2	32	36

1650

Metric Perfored Bolt

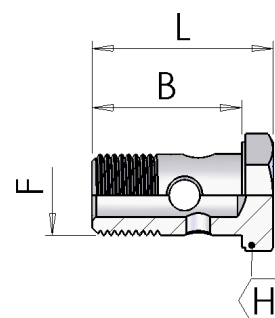

Part number	Dimensions			
	B	F	H	L
1650-00-10	19	M10-1	14	24
1650-00-12	26	M12-1.5	17	31
1650-00-14	29	M14-1.5	19	34
1650-00-16	33	M16-1.5	22	41
1650-00-18	37	M18-1.5	24	44
1650-00-20	38	M20-1.5	27	46
1650-00-22	38	M22-1.5	27	46
1650-00-26	47	M26-1.5	32	56
1650-00-30	58	M30-1.5	36	68

0550

Metric Standpipe

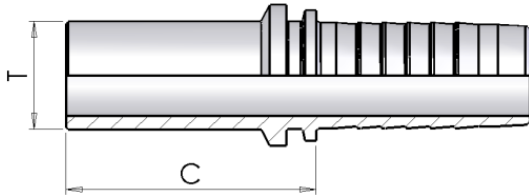

Part number	Hose I.D.		Dimensions			
	in	mm	Type	Dash size	Pipe T	Cut-Off C
0550-03-06	3/16	4.8	L/S	03	6	30
0550-03-08	3/16	4.8	L/S	03	8	29
0550-04-06	1/4	6.4	L/S	04	6	32
0550-04-08	1/4	6.4	L/S	04	8	30
0550-04-10	1/4	6.4	L/S	04	10	33
0550-04-12	1/4	6.4	L/S	04	12	30
0550-05-08	5/16	7.9	L/S	05	08	31
0550-05-10	5/16	7.9	L/S	05	10	31
0550-05-12	5/16	7.9	L/S	05	12	33
0550-06-08	3/8	9.5	L/S	06	08	33
0550-06-10	3/8	9.5	L/S	06	10	33
0550-06-12	3/8	9.5	L/S	06	12	32
0550-06-14	3/8	9.5	S	06	14	37
0550-06-15	3/8	9.5	L	06	15	32
0550-08-12	1/2	12.7	L/S	08	12	36
0550-08-14	1/2	12.7	S	08	14	39
0550-08-15	1/2	12.7	L	08	15	34
0550-08-16	1/2	12.7	S	08	16	39
0550-08-18	1/2	12.7	L	08	18	35
0550-08-20	1/2	12.7	S	08	20	45
0550-10-18	5/8	15.9	L	10	18	35
0550-10-20	5/8	15.9	S	10	20	45
0550-10-22	5/8	15.9	L	10	22	33
0550-12-18	3/4	19	L	12	18	37
0550-12-20	3/4	19	S	12	20	46
0550-12-22	3/4	19	L	12	22	38
0550-12-25	3/4	19	S	12	25	49
0550-12-28	3/4	19	L	12	28	40
0550-16-25	1	25.4	S	16	25	51
0550-16-28	1	25.4	L	16	28	41
0550-16-30	1	25.4	S	16	30	54
0550-16-38	1	25.4	S	16	38	60
0550-20-30	1.1/4	31.8	S	20	30	58
0550-20-35	1.1/4	31.8	L	20	35	48
0550-20-38	1.1/4	31.8	S	20	38	62
0550-24-38	1.1/2	38.1	S	24	38	63
0550-24-42	1.1/2	38.1	L	24	42	50

0650

90° Metric Standpipe

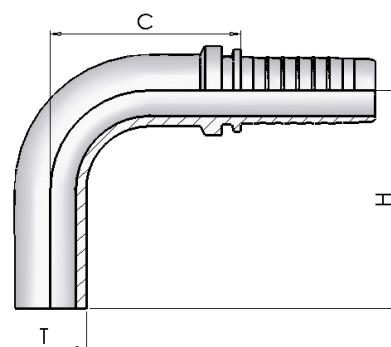

Part number	Hose I.D.		Dimensions				
	in	mm	Type	Dash size	Pipe T	Cut-Off C	H
0650-03-06	3/16	4.8	L/S	03	6	20	32
0650-04-06	1/4	6.4	L/S	04	6	23	32
0650-04-08	1/4	6.4	L/S	04	8	25	34
0650-04-10	1/4	6.4	L/S	04	10	25	43
0650-05-10	5/16	7.9	L/S	05	10	29	40
0650-05-12	5/16	7.9	L/S	05	12	29	45
0650-06-10	3/8	9.5	L/S	06	10	27	40
0650-06-12	3/8	9.5	L/S	06	12	30	44

0650S

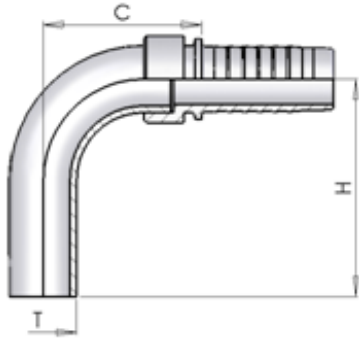

90° Metric Standpipe (Welded)

Part number	Hose I.D.		Dimensions				
	in	mm	Type	Dash size	Pipe T	Cut-Off C	H
0650S06-15	3/8	9.5	L	06	15	39	52
0650S03-08	3/16	4.8	L/S	03	8	25	41
0650S04-12	1/4	6.4	L/S	04	12	35	44
0650S05-08	5/16	7.9	L/S	05	8	27	41
0650S06-14	3/8	9.5	S	06	14	36	46
0650S08-12	1/2	12.7	L/S	08	12	33	44
0650S08-14	1/2	12.7	S	08	14	36	46
0650S08-15	1/2	12.7	L	08	15	39	52
0650S08-16	1/2	12.7	S	08	16	42	56
0650S08-18	1/2	12.7	L	08	18	42	56
0650S10-18	5/8	15.9	L	10	18	42	56
0650S10-20	5/8	15.9	S	10	20	48	65
0650S10-22	5/8	15.9	L	10	22	51	71
0650S12-20	3/4	19	S	12	20	48	65
0650S12-22	3/4	19	L	12	22	51	71
0650S12-25	3/4	19	S	12	25	57	75
0650S16-25	1	25.4	S	16	25	57	75
0650S16-28	1	25.4	L	16	28	60	89
0650S16-30	1	25.4	S	16	30	65	89
0650S20-30	1.1/4	31.8	S	20	30	66	89
0650S20-35	1.1/4	31.8	L	20	35	76	98
0650S20-38	1.1/4	31.8	S	20	38	83	102
0650S24-38	1.1/2	38.1	S	24	38	82	102
0650S24-42	1.1/2	38.1	L	24	42	106	125

0750

45° Metric Standpipe

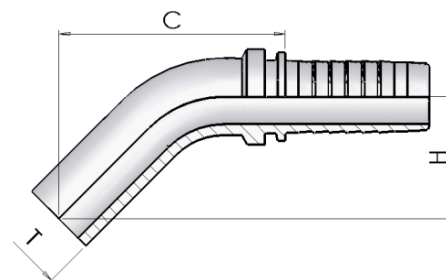

Part number	Hose I.D.		Dimensions				
	in	mm	Type	Dash size	Pipe T	Cut-Off C	H
0750-04-06	1/4	6.4	L/S	04	6	41	24
0750-04-08	1/4	6.4	L/S	04	8	43	25
0750-04-10	1/4	6.4	L/S	04	10	47	30
0750-05-10	5/16	7.9	L/S	05	10	49	30
0750-05-12	5/16	7.9	L/S	05	12	53	32
0750-06-12	3/8	9.5	L/S	06	12	52	33

0750S

45° Metric Standpipe (Welded)

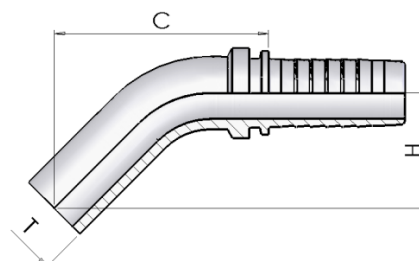

Part number	Hose I.D.		Dimensions				
	in	mm	Type	Dash size	Pipe T	Cut-Off C	H
0750S03-08	3/16	4.8	L/S	03	8	41	23
0750S04-12	1/4	6.4	L/S	04	12	54	29
0750S06-14	3/8	9.5	S	06	14	50	27
0750S06-15	3/8	9.5	L	06	15	54	29
0750S08-14	1/2	12.7	S	08	14	50	27
0750S08-15	1/2	12.7	L	08	15	55	29
0750S08-16	1/2	12.7	S	08	16	54	27
0750S08-18	1/2	12.7	L	08	18	56	29
0750S10-18	5/8	15.9	L	10	18	56	29
0750S10-20	5/8	15.9	S	10	20	56	34
0750S10-22	5/8	15.9	L	10	22	66	35
0750S12-20	3/4	19	S	12	20	63	34
0750S12-22	3/4	19	L	12	22	65	35
0750S12-25	3/4	19	S	12	25	76	41
0750S16-25	1	25.4	S	16	25	76	41
0750S16-28	1	25.4	L	16	28	84	49
0750S16-30	1	25.4	S	16	30	86	44
0750S20-30	1.1/4	31.8	S	20	30	88	44
0750S20-35	1.1/4	31.8	L	20	35	94	47
0750S20-38	1.1/4	31.8	S	20	38	101	50
0750S24-38	1.1/2	38.1	S	24	38	100	50
0750S24-42	1.1/2	38.1	L	24	42	114	55

0030

Metric Female 24° Cone French Type

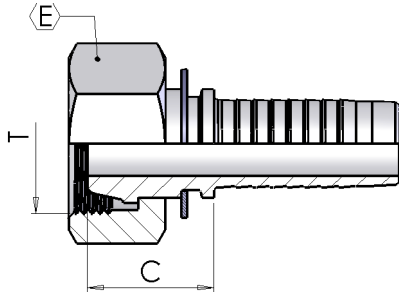

Part number	Hose I.D.		Dimensions			
	in	mm	Dash size	Thread T	Hex E	Cut-Off C
0030-05-20	5/16	7.9	05	M20-1.5	24	25
0030-06-20	3/8	9.5	06	M20-1.5	24	26
0030-08-24	1/2	12.7	08	M24-1.5	30	28
0030-10-30	5/8	15.9	10	M30-1.5	36	25
0030-12-30	3/4	19	12	M30-1.5	36	26
0030-12-36	3/4	19	12	M36-1.5	46	29
0030-16-45	1	25.4	16	M45-1.5	55	30
0030-20-52	1.1/4	31.8	20	M52-1.5	65	34

0130

90° Metric Swept Elbow 24° Cone French Type

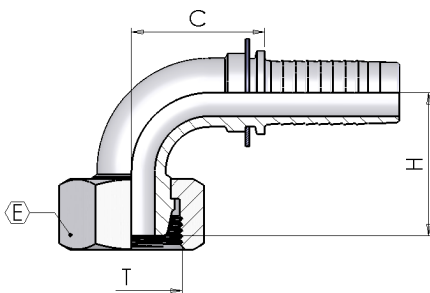

Part number	Hose I.D.		Dimensions				
	in	mm	Dash size	Thread T	Hex E	Cut-Off C	H
0130-05-20	5/16	7.9	05	M20-1.5	24	29	35
0130-06-20	3/8	9.5	06	M20-1.5	24	33	35
0130-08-24	1/2	12.7	08	M24-1.5	30	43	40
0130S10-30	5/8	15.9	10	M30-1.5	36	48	49
0130-12-36	3/4	19	12	M36-1.5	46	56	55

FK50

K' Female

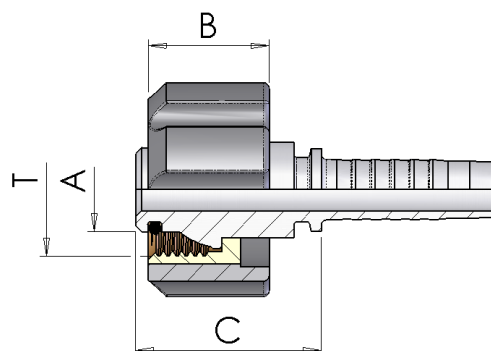

Part number	Hose I.D.		Dimensions				
	in	mm	Dash size	Thread T	Cut-Off C	A	B
FK50-04-22	1/4	6.4	04	M22-1.5	31	14	20
FK50-05-22	5/16	7.9	05	M22-1.5	31	14	20
FK50-06-22	3/8	9.5	06	M22-1.5	31	14	20
FK50-04022	1/4	6.4	04	M22-1.5	31	14	27
FK50-05022	5/16	7.9	05	M22-1.5	31	14	27
FK50-06022	3/8	9.5	06	M22-1.5	31	14	27

FN50

'K' Male (For Gun)-Diameter 10

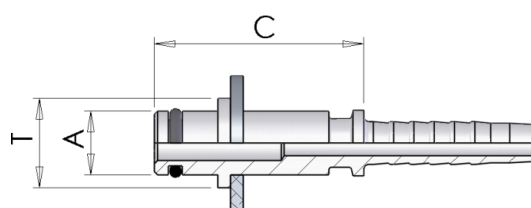

Part number	Hose I.D.		Dimensions			
	in	mm	Dash size	Thread T	A	C
FN50-04-22	1/4	6.4	04	M22-1.5	10	33
FN50-05-22	5/16	7.9	05	M22-1.5	10	33
FN50-06-22	3/8	9.5	06	M22-1.5	10	33

FN51

'K' Male (For Gun)-Diameter 11

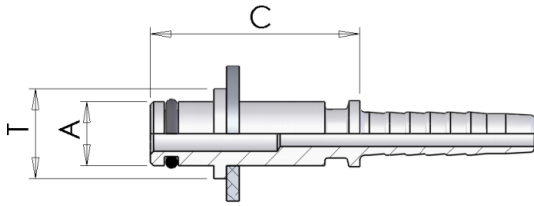

Part number	Hose I.D.		Dimensions			
	in	mm	Dash size	Thread T	A	C
FN51-04-22	1/4	6.4	04	M22-1.5	11	33
FN51-05-22	5/16	7.9	05	M22-1.5	11	33
FN51-06-22	3/8	9.5	06	M22-1.5	11	33

0398

Staplelock Male

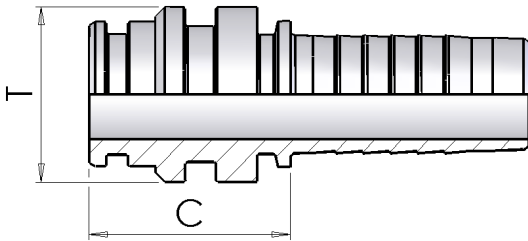

Part number	Hose I.D.		Dimensions		
	in	mm	Dash size	Thread T	Cut-Off C
0398-04-04	1/4	6.4	04	14.9	32
0398-06-06	3/8	9.5	06	19.9	35
0398-08-08	1/2	12.7	08	23.9	33
0398-12-12	3/4	19	12	28.9	33
0398-16-16	1	25.4	16	38.8	39
0398-20-20	1.1/4	31.8	20	45.9	41

KO5B

Kobelko Male

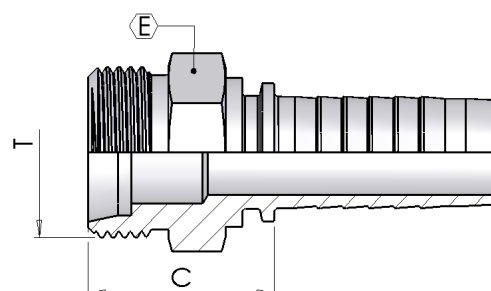

Part number	Hose I.D.		Dimensions				
	in	mm	Dash size	Thread T	Tube	Hex E	Cut-Off C
KO5B-10-30	5/8	15.9	10	M30-1.5	22	32	32
KO5B-12-30	3/4	19	12	M30-1.5	22	32	35
KO5B-12-36	3/4	19	12	M36-1.5	28	41	36
KO5B-16-36	1	25.4	16	M36-1.5	28	41	37
KO5B-16-45	1	25.4	16	M45-1,5	35	50	38

S350

ORFS Male Maschio ORFS

- with plug and O'Ring

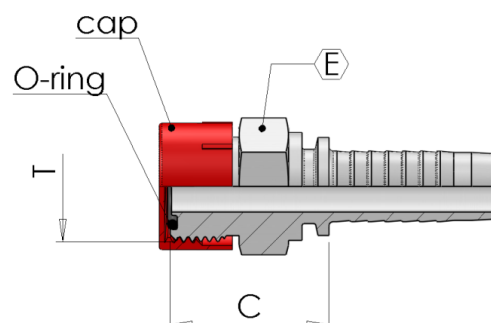

Part number	Hose I.D.		Dimensions			
	in	mm	Dash size	Thread T	Hex E	Cut-Off C
S350-04-06-BO	1/4	6.4	04	9/16-18	17	23
S350-04-09-BO	1/4	6.4	04	11/16-16	19	21
S350-05-09-BO	5/16	7.9	05	11/16-16	19	26
S350-06-09-BO	3/8	9.5	06	11/16-16	19	26
S350-06-11-BO	3/8	9.5	6	13/16-16	22	29
S350-08-11-BO	1/2	12.7	08	13/16-16	22	29
S350-08-13-BO	1/2	12.7	08	1-14	27	34
S350-08-14-BO	1/2	12.7	08	1.3/16-12	32	35
S350-10-13-BO	5/8	15.9	10	1-14	27	33
S350-10-14-BO	5/8	15.9	10	1.3/16-12	32	35
S350-12-14-BO	3/4	19	12	1.3/16-12	32	36
S350-12-15-BO	3/4	19	12	1.7/16-12	38	36
S350-16-15-BO	1	25.4	16	1.7/16-12	38	37
S350-16-21-BO	1	25.4	16	1.11/16-12	46	38
S350-20-21-BO	1.1/4	31.8	20	1.11/16-12	46	39

S050

ORFS Female

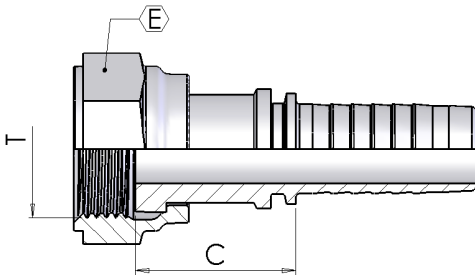

Part number	Hose I.D.		Dimensions			
	in	mm	Dash size	Thread T	Hex E	Cut-Off C
S050-04-06	1/4	6.4	04	9/16-18	19	25
S050-04-09	1/4	6.4	04	11/16-16	22	29
S050-05-09	5/16	7.9	05	11/16-16	22	29
S050-06-09	3/8	9.5	06	11/16-16	22	29
S050-06-11	3/8	9.5	06	13/16-16	24	30
S050-08-11	1/2	12.7	08	13/16-16	24	32
S050-08-13	1/2	12.7	08	1-14	30	35
S050-08-14	1/2	12.7	08	1.3/16-12	36	37
S050-10-13	5/8	15.9	10	1-14	30	35
S050-10-14	5/8	15.9	10	1.3/16-12	36	34
S050-12-13	3/4	19	12	1-14	30	37
S050-12-14	3/4	19	12	1.3/16-12	36	35
S050-12-15	3/4	19	12	1.7/16-12	41	41
S050-16-15	1	25.4	16	1.7/16-12	41	39
Slip on nut S050-20-21	1.1/4	31.8	20	1.11/16-12	50	40
Slip on nut S050-24-32	1.1/2	38.1	24	2-12	60	41

Slip on nut
Slip on nut

S05T

ORFS Female Back Hexagon

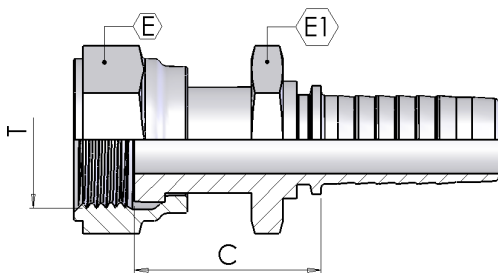

Part number	Hose I.D.		Dimensions				
	in	mm	Dash size	Thread T	Hex E	Cut-Off C	E1
S05T-04-06	1/4	6.4	04	9/16-18	17	30	15
S05T-06-09	3/8	9.5	06	11/16-16	22	34	17
S05T-08-11	1/2	12.7	08	13/16-16	24	37	19
S05T-10-13	5/8	15.9	10	1-14	30	41	24
S05T-12-14	3/4	19	12	1.3/16-12	36	42	30
S05T-16-15	1	25.4	16	1.7/16-12	41	50	36

S150

ORFS 90° Swept Elbow

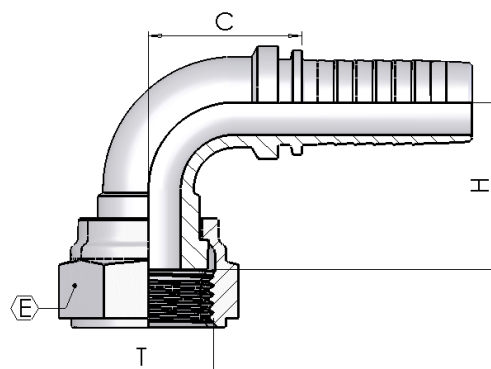

Part number	Hose I.D.		Dimensions				
	in	mm	Dash size	Thread T	Hex E	Cut-Off C	H
S150-04-06	1/4	6.4	04	9/16-18	19	25	26
S150-04-09	1/4	6.4	04	11/16-16	22	25	23
S150-05-09	5/16	7.9	05	11/16-16	22	29	32
S150-06-09	3/8	9.5	06	11/16-16	22	33	33
S150-06-11	3/8	9.5	06	13/16-16	24	33	32
S150-08-11	1/2	12.7	08	13/16-16	24	39	36
S150-08-13	1/2	12.7	08	1-14	30	39	40
S150-08-14	1/2	12.7	08	1.3/16-12	36	42	39
S150-10-13	5/8	15.9	10	1-14	30	47	39
Welded S150-10-14	5/8	15.9	10	1.3/16-12	36	42	39
Welded S150-12-13	3/4	19	12	1-14	30	42	39
S150-12-14	3/4	19	12	1.3/16-12	36	57	49
S150-12-15	3/4	19	12	1.7/16-12	41	56	51
S150-16-15	1	25.4	16	1.7/16-12	41	67	62
Welded S150-16-21	1	25.4	20	1.11/16-12	50	62	58
Welded S150-20-21	1.1/4	31.8	20	1.11/16-12	50	63	58
Welded S150-24-32	1.1/2	38.1	24	2-12	60	80	73

S250

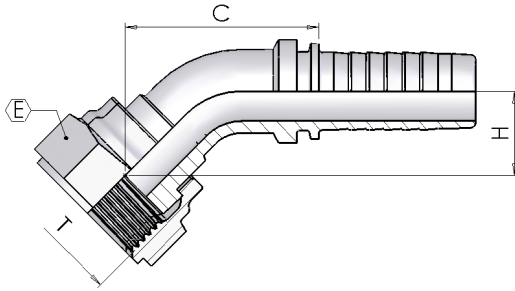

ORFS 45° Swept Elbow

Part number	Hose I.D.		Dimensions				
	in	mm	Dash size	Thread T	Hex E	Cut-Off C	H
S250-04-06	1/4	6.4	04	9/16-18	19	40	14
S250-04-09	1/4	6.4	04	11/16-16	22	38	14
S250-05-09	5/16	7.9	05	11/16-16	22	44	14
S250-06-09	3/8	9.5	06	11/16-16	22	52	17
S250-06-11	3/8	9.5	06	13/16-16	24	51	18
S250-08-11	1/2	12.7	08	13/16-16	24	62	20
S250-08-13	1/2	12.7	08	1-14	30	64	23
S250-08-14	1/2	12.7	08	1.3/16-12	36	62	23
S250-10-13	5/8	15.9	10	1-14	30	67	22
Welded S250-10-14	5/8	15.9	10	1.3/16-12	36	44	18
Welded S250-12-13	3/4	19	12	1-14	30	40	15
S250-12-14	3/4	19	12	1.3/16-12	36	84	23
S250-12-15	3/4	19	12	1.7/16-12	41	84	26
S250-16-15	1	25.4	16	1.7/16-12	41	100	31
Welded S250-20-21	1.1/4	31.8	20	1.11/16-12	50	125	44
Welded S250-24-32	1.1/2	38.1	24	2-12	60	78	29

0920

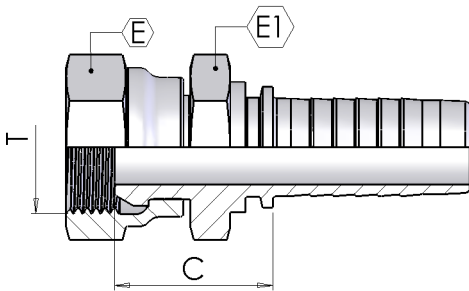

JIS Female 60° Cone (Nissan)

Part number	Hose I.D.		Dimensions				
	in	mm	Dash size	Thread T	Hex E	Cut-Off C	E1
0920-04-04	1/4	6.4	04	1/4-19	19	23	19
0920-06-06	3/8	9.5	06	3/8-19	22	28	22
0920-08-08	1/2	12.7	08	1/2-14	27	27	27
0920-12-12	3/4	19	12	3/4-14	32	29	32
0920-16-16	1	25.4	16	1-11	38	31	38

0930

JIS Female 60° Cone (Toyota)

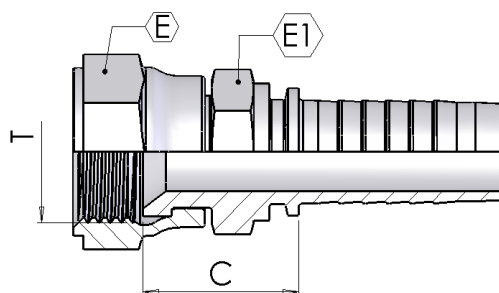

Part number	Hose I.D.		Dimensions				
	in	mm	Dash size	Thread T	Hex E	Cut-Off C	E1
0930-04-04	1/4	6.4	04	1/4-19	19	20	17
0930-06-06	3/8	9.5	06	3/8-19	22	22	19
0930-08-08	1/2	12.7	08	1/2-14	27	26	22
0930-12-12	3/4	19	12	3/4-14	32	29	30
0930-16-16	1	25.4	16	1-11	38	31	36
0930-20-20	1,1/4	31.8	20	1,1/4-11	50	35	46
0930-24-24	1,1/2	38.1	24	1,1/2-11	55	28	50

0980S

90° JIS Swept Elbow (Toyota) - Welded

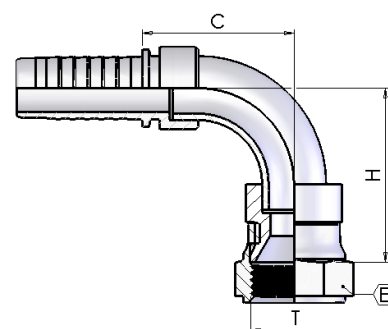

Part number	Hose I.D.		Dimensions				
	in	mm	Dash size	Thread T	Hex E	Cut-Off C	H
0980S04-04	1/4	6.4	04	1/4-19	19	38	35
0980S06-06	3/8	9.5	06	3/8-19	22	27	30
0980S08-08	1/2	12.7	08	1/2-14	27	33	39
0980S12-12	3/4	19	12	3/4-14	32	48	55
0980S16-16	1	25.4	16	1-11	38	57	62
0980S20-20	1,1/4	31.8	20	1,1/4-11	50	63	65
0980S24-24	1,1/2	38.1	24	1,1/2-11	55	80	83

1030S

45° JIS Swept Elbow (Toyota) - Welded

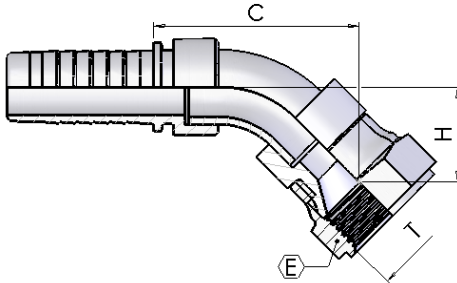

Part number	Hose I.D.		Dimensions				
	in	mm	Dash size	Thread T	Hex E	Cut-Off C	H
1030S04-04	1/4	6.4	04	1/4-19	19	44	18
1030S05-06	5/16	7.9	05	3/8-19	22	38	18
1030S06-06	3/8	9.5	06	3/8-19	22	38	18
1030S08-08	1/2	12.7	08	1/2-14	27	40	20
1030S12-12	3/4	19	12	3/4-14	32	56	26
1030S16-16	1	25.4	16	1-11	38	72	33
1030S20-20	1,1/4	31.8	20	1,1/4-11	50	67	29
1030S24-24	1,1/2	38.1	24	1,1/2-11	55	85	36

0940

JIS Female 60° Cone (Komatsu)

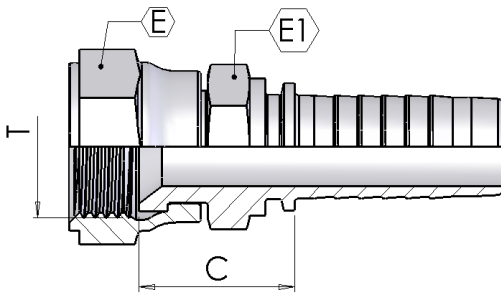

Part number	Hose I.D.		Dimensions				
	in	mm	Dash size	Thread T	Hex E	Cut-Off C	E1
0940-04-14	1/4	6.4	04	M14x1,5	19	22	17
0940-05-16	5/16	7.9	05	M16x1,5	22	22	17
0940-06-14	3/8	9.5	06	M14x1,5	19	22	17
0940-06-18	3/8	9.5	06	M18x1,5	24	21	19
0940-08-22	1/2	12.7	08	M22x1,5	27	27	22
0940-10-24	5/8	15.9	10	M24x1,5	30	26	27
0940-12-30	3/4	19	12	M30x1,5	36	30	30
0940-16-33	1	25.4	16	M33x1,5	41	33	36
0940-20-36	1.1/4	31.8	20	M36x1,5	46	37	46
0940-24-42	1.1/2	38.1	24	M42x1,5	50	38	50

0990S

90° JIS Swept Elbow (Komatsu) - Welded

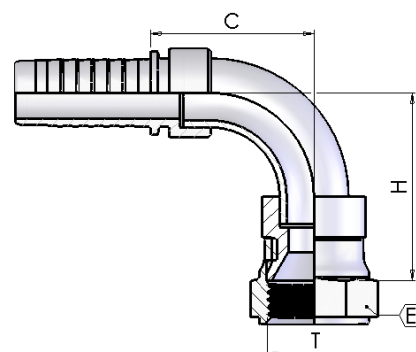

Part number	Hose I.D.		Dimensions				
	in	mm	Dash size	Thread T	Hex E	Cut-Off C	H
0990S04-14	1/4	6.4	04	M14x1,5	19	38	35
0990S05-16	5/16	7.9	05	M16x1,5	22	27	30
0990S06-14	3/8	9.5	06	M14x1,5	19	31	33
0990S06-18	3/8	9.5	06	M18x1,5	24	31	33
0990S08-22	1/2	12.7	08	M22x1,5	27	33	39
0990S10-24	5/8	15.9	10	M24x1,5	30	42	48
0990S12-30	3/4	19	12	M30x1,5	36	48	43
0990S16-33	1	25.4	16	M33x1,5	41	57	62

1040S

45° JIS Swept Elbow (Komatsu) - Welded

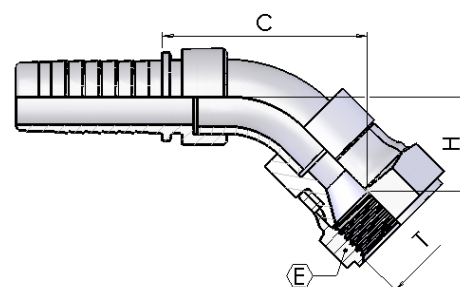

Part number	Hose I.D.		Dimensions				
	in	mm	Dash size	Thread T	Hex E	Cut-Off C	H
1040S-04-14	1/4	6.4	04	M14-1.5	19	44	18
1040S05-16	5/16	7.9	05	M16-1.5	22	38	18
1040S06-14	3/8	9.5	06	M14-1.5	19	41	18
1040S06-18	3/8	9.5	06	M18-1.5	24	43	18
1040S08-22	1/2	12.7	08	M22-1.5	27	40	20
1040S10-24	5/8	15.9	10	M24-1.5	30	50	26
1040S12-30	3/4	19	12	M30-1.5	36	56	26
1040S16-33	1	25.4	16	M33-1.5	41	65	33

1050

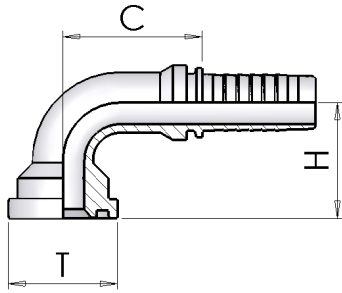

Komatsu Flange 90°

Part number	Hose I.D.		Dash size	Dimensions			
	in	mm		Flange		Drop	Cut-Off
				T	mm	H	C
Welded 1050-10-10	5/8	15.9	10	5/8	34	47	58

1150

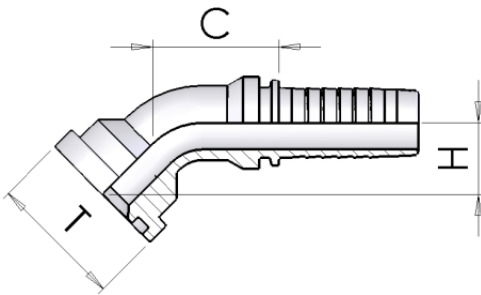

Komatsu Flange 45°

Part number	Hose I.D.		Dash size	Dimensions			
	in	mm		Flange		Drop	Cut-Off
				T	mm	H	C
Welded 1150-10-10	5/8	15.9	10	5/8	34	54	23

1250

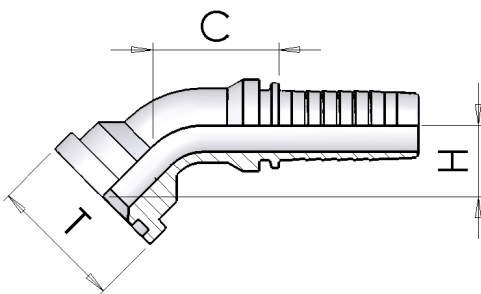

Komatsu Flange - Straight

Part number	Hose I.D.		Dash size	Dimensions		
	in	mm		Flange		Cut-Off
				T	mm	C
1250-10-10	5/8	15.9	10	5/8	34	56

1260

Straight SAE Flange 3000 PSI

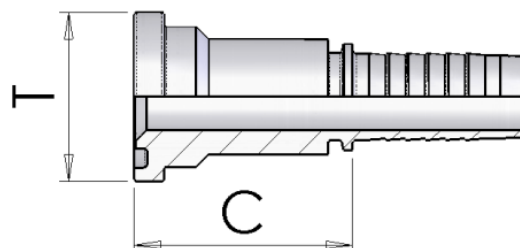

Part number	Hose I.D.		Dimensions			
	in	mm	Dash size	Flange		Cut-Off
				T	mm	C
1260-08-08	1/2	12.7	08	1/2	30,2	45
1260-08-12	1/2	12.7	08	3/4	38.1	50
1260-10-08	5/8	15.9	10	1/2	30,2	45
1260-10-12	5/8	15.9	10	3/4	38.1	49
1260-12-12	3/4	19	12	3/4	38.1	50
1260-12-16	3/4	19	12	1	44.5	53
1260-16-16	1	25.4	16	1	44.5	54
1260-16-20	1	25.4	16	1.1/4	50.8	57
1260-20-20	1.1/4	31.8	20	1.1/4	50.8	59
1260-20-24	1.1/4	31.8	20	1.1/2	60.3	62
1260-24-24	1.1/2	38.1	24	1.1/2	60.3	62
1260-24-32	1.1/2	38.1	24	2	71.4	67
1260-32-32	2	50.8	32	2	71.4	68
1260-32-40	2	50.8	32	2.1/2	84.1	76
1260-40-40	2.1/2	63,5	40	2.1/2	84	76
1260-48-48	3	76,2	48	3	102	63

1060

90° SAE Flange 3000 PSI

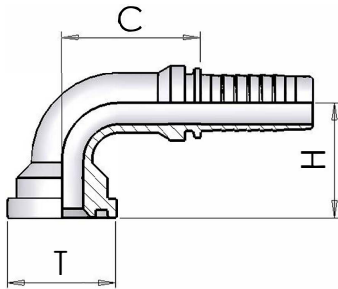

Part number	Hose I.D.		Dimensions				
	in	mm	Dash size	Flange		Drop	Cut-Off
				T	mm	H	C
1060-08-08	1/2	12.7	08	1/2	30,2	39	39
1060-08-12	1/2	12.7	08	3/4	38.1	44	39
1060-10-08	5/8	15.9	10	1/2	30,2	42	45
1060-10-12	5/8	15.9	10	3/4	38.1	47	45
1060-12-12	3/4	19	12	3/4	38.1	53	56
1060-12-16	3/4	19	12	1	44.5	58	56
1060-16-16	1	25.4	16	1	44.5	65	70
1060-16-20	1	25.4	16	1.1/4	50.8	70	70
1060-16-24	1	25.4	16	1.1/2	60.3	71	72
1060-20-16	1.1/4	31.8	20	1	44.5	77	81
1060-20-20	1.1/4	31.8	20	1.1/4	50.8	77	86
1060-20-24	1.1/4	31.8	20	1.1/2	60.3	81	85
1060-24-24	1.1/2	38.1	24	1.1/2	60.3	89	98
1060-24-32	1.1/2	38.1	24	2	71.4	97	93
1060-32-32	2	50.8	32	2	71.4	121	123

1160

45° SAE Flange 3000 PSI

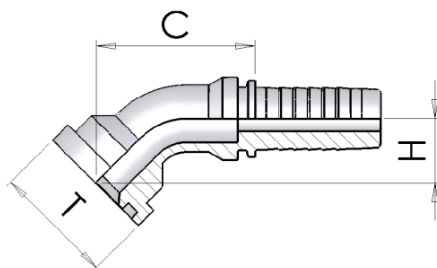

Part number	Hose I.D.		Dimensions				
	in	mm	Dash size	Flange		Cut-Off	H
				T	mm	C	
1160-08-08	1/2	12.7	08	1/2	30.2	62	22
1160-08-12	1/2	12.7	08	3/4	38.1	67	25
1160-12-12	3/4	19	12	3/4	38.1	69	27
1160-12-16	3/4	19	12	1	44.5	88	30
1160-16-16	1	25.4	16	1	44.5	82	33
1160-20-20	1.1/4	31.8	20	1.1/4	50.8	102	38
1160-20-24	1.1/4	31.8	20	1.1/2	60.3	129	39
1160-24-24	1.1/2	38.1	24	1.1/2	60.3	114	44
1160-24-32	1.1/2	38.1	24	2	71.4	148	47
1160-32-32	2	50.8	32	2	71.4	130	58

1060

22.5°/30°/60°/67.5° SAE Flange 3000 PSI

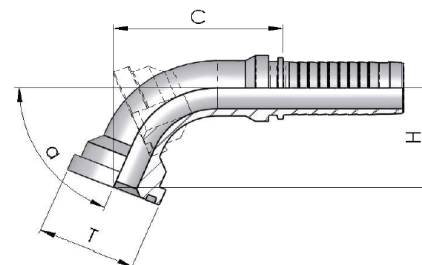

Part number	Hose I.D.		Dimensions					
	in	mm	Dash size	Flange		Degree	Drop H	Cut-Off C
				T	mm			
1060-12-12 22.5	3/4	19	12	3/4	38.1	22.5°	11	76
1060-16-16 22.5	1	25.4	16	1	44.5	22.5°	14	89
1060-20-20 22.5	1.1/4	31.8	20	1.1/4	50.8	22.5°	14	111
1060-24-24 22.5	1.1/2	38.1	24	1.1/2	60.3	22.5°	17	124
1060-32-32 22.5	2	50.8	32	2	71.4	22.5°	28	144
1060-12-12 30	3/4	19	12	3/4	38.1	30°	16	75
1060-16-16 30	1	25.4	16	1	44.5	30°	19	87
1060-20-20 30	1.1/4	31.8	20	1.1/4	50.8	30°	26	109
1060-24-24 30	1.1/2	38.1	24	1.1/2	60.3	30°	23	122
1060-32-32 30	2	50.8	32	2	71.4	30°	35	142
1060-12-12 60	3/4	19	12	3/4	38.1	60°	36	76
1060-16-16 60	1	25.4	16	1	44.5	60°	43	95
1060-20-20 60	1.1/4	31.8	20	1.1/4	50.8	60°	49	116
1060-24-24 60	1.1/2	38.1	24	1.1/2	60.3	60°	55	138
1060-32-32 60	2	50.8	32	2	71.4	60°	80	170
1060-12-12 67.5	3/4	19	12	3/4	38.1	67.5°	41	72
1060-16-16 67.5	1	25.4	16	1	44.5	67.5°	48	91
1060-20-20 67.5	1.1/4	31.8	20	1.1/4	50.8	67.5°	56	110
1060-24-24 67.5	1.1/2	38.1	24	1.1/2	60.3	67.5°	63	131
1060-32-32 67.5	2	50.8	32	2	71.4	67.5°	92	158

FS3L

90° SAE Flange 3000 Psi - Long Drop

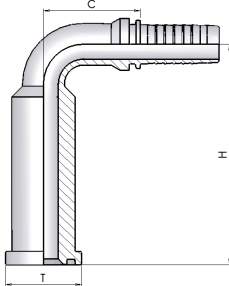

Part number	Hose I.D.		Dimensions				
	in	mm	Dash size	Flange		Drop	Cut-Off
				T	mm	H	C
FS3L-08-08	1/2	12.7	08	1/2	30.2	73	39
FS3L-12-12	3/4	19	12	3/8	38.1	123	56
FS3L-16-16	1	25.4	16	1	44.5	127	70
FS3L-20-20	1.1/4	31.8	20	1.1/4	50.8	178	85
FS3L-24-24	1.1/2	38.1	24	1.1/2	60.3	220	99

S003

Cut Split Flanges 3000 psi

This product is sold in pairs

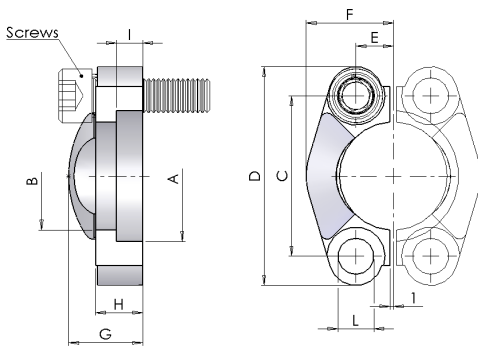

Part number	SAE Size	Dimensions									
		Hex E	A	B	C	D	F	G	H	I	L
S003-08	1/2"	8.7	30.96	24.3	38.1	54	22.8	19	13	6.2	8.8
S003-12	3/4"	11.1	38.89	32.1	47.6	65	25.9	22	14	6.2	10.8
S003-16	1"	13.1	45.24	38.5	52.4	70	29.2	24	16	7.5	10.8
S003-20	1.1/4"	15.1	51.59	43.7	58.7	79	36.3	22	14	7.5	12
S003-24	1.1/2"	17.9	61.09	50.8	69.9	94	41.1	25	16	7.5	13.5
S003-32	2"	21.4	72.24	62.7	77.8	102	48.2	26	16	9	13.5
S003-40	2.1/2"	25.4	84.94	74.9	88.9	114	54.1	38	19	9	13.5
S003-48	3"	31	102.4	90.9	106.4	135	65.3	41	22	9	17

1310

Straight SAE Flange 6000 PSI

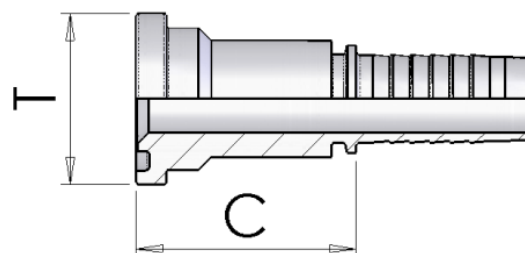

Part number	Hose I.D.		Dimensions			
	in	mm	Dash size	Flange		Cut-Off C
				T	mm	
1310-08-08	1/2	12.7	08	1/2	31,8	46
1310-08-12	1/2	12.7	08	3/4	41.3	53
1310-10-08	5/8	15.9	10	1/2	31,8	46
1310-10-12	5/8	15.9	10	3/4	41.3	53
1310-10-16	5/8	15.9	10	1	47.6	59
1310-12-12	3/4	19	12	3/4	41.3	54
1310-12-16	3/4	19	12	1	47.6	60
1310-16-12	1	25.4	16	3/4	41.3	55
1310-16-16	1	25.4	16	1	47.6	61
1310-16-20	1	25.4	16	1.1/4	54	68
1310-20-20	1.1/4	31.8	20	1.1/4	54	70
1310-20-24	1.1/4	31.8	20	1.1/2	63.5	76
1310-24-24	1.1/2	38.1	24	1.1/2	63.5	76
1310-24-32	1.1/2	38.1	24	2	79.4	85
1310-32-32	2	50.8	32	2	79.4	85

1110

90° SAE Flange 6000 PSI

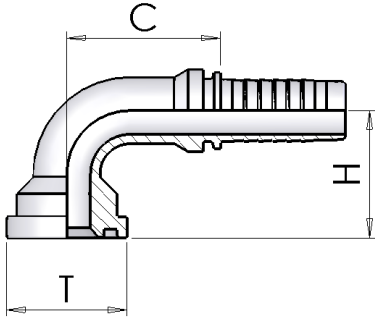

Part number	Hose I.D.		Dimensions				
	in	mm	Dash size	Flange T	Flange mm	Drop H	Cut-Off C
1110-08-08	1/2	12.7	08	1/2	31.8	39	39
1110-08-12	1/2	12.7	08	3/4	41.3	48	39
1110-10-08	5/8	15.9	10	1/2	31.8	42	45
1110-10-12	5/8	15.9	10	3/4	41.3	52	44
1110-10-16	5/8	15.9	10	1	47.6	56	45
1110-12-08	3/4	19	12	1/2	32	54	56
1110-12-12	3/4	19	12	3/4	41.3	55	56
1110-12-16	3/4	19	12	1	47.6	63	56
1110-16-12	1	25.4	16	3/4	41.3	64	68
1110-16-16	1	25.4	16	1	47.6	69	70
1110-16-20	1	25.4	16	1.1/4	54	74	71
1110-20-20	1.1/4	31.8	20	1.1/4	54	83	97
1110-20-24	1.1/4	31.8	20	1.1/2	63.5	90	97
1110-24-24	1.1/2	38.1	24	1.1/2	63.5	99	102
1110-24-32	1.1/2	38.1	24	2	79.4	108	103
1110-32-32	2	50.8	32	2	79.4	136	125

1210

45° SAE Flange 6000 PSI

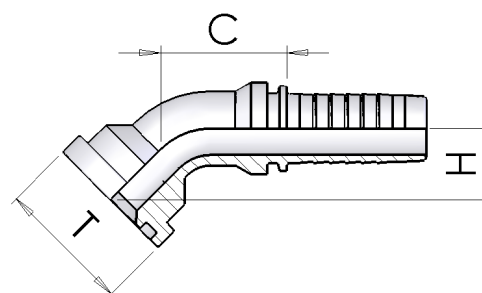

Part number	Hose I.D.		Dimensions				
	in	mm	Dash size	Flange		Drop H	Cut-Off C
				T	mm		
1210-08-08	1/2	12.7	08	1/2	31.8	22	62
1210-08-12	1/2	12.7	08	3/4	41.3	28	69
1210-10-08	5/8	15.9	10	1/2	31.8	21	66
1210-10-12	5/8	15.9	10	3/4	41.3	27	75
1210-10-16	5/8	15.9	10	1	47.6	32	77
1210-12-12	3/4	19	12	3/4	41.3	28	74
1210-12-16	3/4	19	12	1	47.6	32	90
1210-16-12	1	25.4	16	3/4	41.3	30	101
1210-16-16	1	25.4	16	1	47.6	34	86
1210-16-20	1	25.4	16	1.1/4	54	41	112
1210-20-20	1.1/4	31.8	20	1.1/4	54	43	107
1210-20-24	1.1/4	31.8	20	1.1/2	63.5	48	149
1210-24-24	1.1/2	38.1	24	1.1/2	63.5	50	122
1210-24-32	1.1/2	38.1	24	2	79.4	66	163
1210-32-32	2	50.8	32	2	79.4	68	145

FS6L

90° SAE Flange 6000 Psi - Long Drop

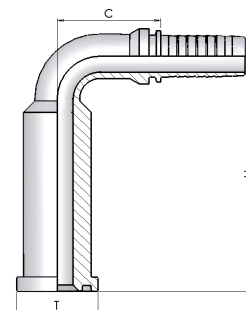

Part number	Hose I.D.		Dimensions				
	in	mm	Dash size	Flange		Drop H	Cut-Off C
				T	mm		
FS6L-08-08	1/2	12.7	08	1/2	32	75	40
FS6L-12-12	3/4	19	12	3/4	41.3	126	56
FS6L-16-16	1	25.4	16	1	47.6	132	70
FS6L-20-20	1.1/4	31.8	20	1.1/4	54	185	82
FS6L-24-24	1.1/2	38.1	24	1.1/2	63.5	233	99

S006

Cut Split Flanges 6000 psi

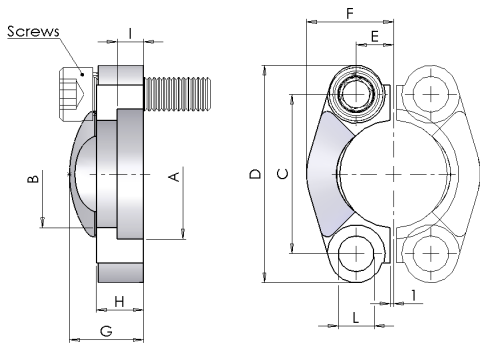

This product is sold in pairs

Part number	SAE Size	Dimensions									
		Hex E	A	B	C	D	F	G	H	I	L
S006-08	1/2"	9.1	32.54	24.6	40.5	56	23.6	22	16	7.2	8.8
S006-12	3/4"	11.9	42.06	32.5	50.8	71	30	28	19	8.3	11
S006-16	1"	13.9	48.41	38.9	57.2	81	34.8	33	24	9	13
S006-20	1 1/4"	15.9	54.76	44.5	66.7	95	38.6	38	27	9.8	15
S006-24	1 1/2"	18.3	64.29	51.6	79.4	113	47.5	43	30	12.1	17
S006-32	2"	22.2	80.16	67.6	96.8	133	56.9	52	37	12.1	21

130S

Straight 'CAT' Flange

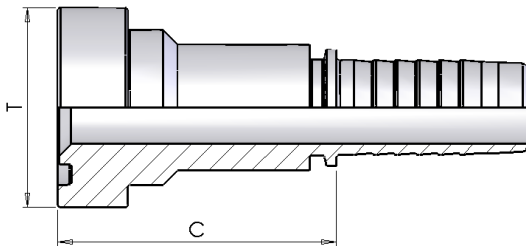

Part number	Hose I.D.		Dash size	Dimensions		Cut-Off C
	in	mm		Flange T	mm	
130S-12-12	3/4	19	12	3/4	41.3	58
130S-12-16	3/4	19	12	1	47.6	64
130S-16-16	1	25.4	16	1	47.6	65
130S-16-20	1	25.4	16	1.1/4	54	73
130S-20-20	1.1/4	31.8	20	1.1/4	54	74
130S-20-24	1.1/4	31.8	20	1.1/2	63.5	78
130S-24-24	1.1/2	38.1	24	1.1/2	63.5	80

110S

90° 'CAT' Flange

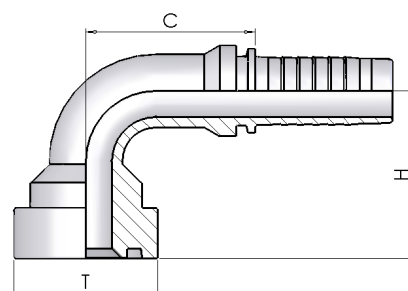

Part number	Hose I.D.		Dimensions				
	in	mm	Dash size	Flange		Cut-Off C	H
				T	mm		
110S-12-12	3/4	19	12	3/4	41.3	56	62
110S-12-16	3/4	19	12	1	47.6	56	65
110S-16-16	1	25.4	16	1	47.6	78	74
110S-16-20	1	25.4	16	1.1/4	54	78	80
110S-20-20	1.1/4	31.8	20	1.1/4	54	97	90
110S-20-24	1.1/4	31.8	20	1.1/2	63.5	96	95
110S-24-24	1.1/2	38.1	24	1.1/2	63.5	115	104

120S

45° 'CAT' Flange

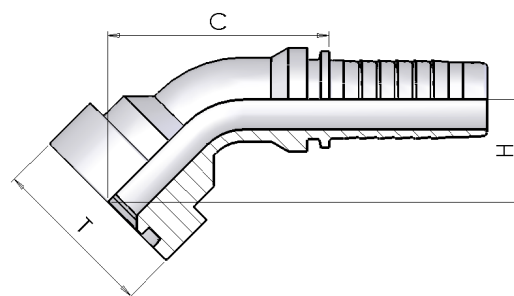

Part number	Hose I.D.		Dimensions				
	in	mm	Dash size	Flange		Cut-Off C	H
				T	mm		
120S-12-12	3/4	19	12	3/4	41.3	88	32
120S-12-16	3/4	19	12	1	47.6	93	37
120S-16-16	1	25.4	16	1	47.6	118	40
120S-16-20	1	25.4	16	1.1/4	54	122	44
120S-20-20	1.1/4	31.8	20	1.1/4	54	146	44
120S-20-24	1.1/4	31.8	20	1.1/2	63.5	149	48
120S-24-24	1.1/2	38.1	24	1.1/2	63.5	172	52

D050

Hose Junction

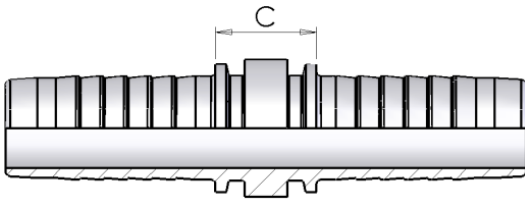

Part number	Hose I.D.		Dimensions	
	in	mm	Dash size	Cut-Off C
D050-03	3/16	4.8	03	17
D050-04	1/4	6.4	04	17
D050-05	5/16	7.9	05	17
D050-06	3/8	9.5	06	17
D050-08	1/2	12.7	08	18
D050-10	5/8	15.9	10	18
D050-12	3/4	19	12	19
D050-16	1	25.4	16	21
D050-20	1.1/4	31.8	20	24
D050-24	1.1/2	38.1	24	24
D050-32	2	50.8	32	26

GS00

Weldable Fitting

without zinc plating

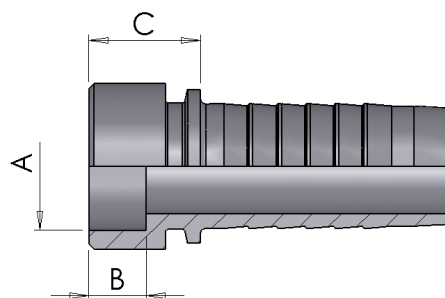

Part number	Hose I.D.		Dimensions			
	in	mm	Dash size	Cut-Off C	A	B
GS00-03-06	3/16	4,8	03	12	06	6
GS00-03-08	3/16	4,8	03	12	08	6
GS00-04-06	1/4	6.4	04	14	06	6
GS00-04-08	1/4	6.4	04	14	08	6
GS00-04-10	1/4	6.4	04	15	10	6
GS00-04-12	1/4	6.4	04	17	12	7
GS00-05-08	5/16	7,9	05	14	08	6
GS00-05-10	5/16	7,9	05	14	10	6
GS00-05-12	5/16	7,9	05	14	12	6
GS00-06-06	3/8	9.5	06	15	06	6
GS00-06-08	3/8	9.5	06	15	08	6
GS00-06-10	3/8	9.5	06	14	10	6
GS00-06-12	3/8	9.5	06	15	12	7
GS00-06-14	3/8	9.5	06	15	14	8
GS00-06-15	3/8	9.5	06	14	15	7
GS00-08-12	1/2	12.7	08	15	12	7
GS00-08-14	1/2	12.7	08	15	14	8
GS00-08-15	1/2	12.7	08	15	15	7
GS00-08-16	1/2	12.7	08	15	16	7
GS00-08-18	1/2	12.7	08	15	18	7
GS00-08-20	1/2	12.7	08	18	20	9
GS00-10-12	5/8	15.9	10	15	12	7
GS00-10-16	5/8	15.9	10	16	16	8
GS00-10-18	5/8	15.9	10	16	18	8
GS00-10-20	5/8	15.9	10	18	20	9
GS00-10-22	5/8	15.9	10	18	22	9
GS00-12-16	3/4	19	12	16	16	8
GS00-12-18	3/4	19	12	16	18	8
GS00-12-20	3/4	19	12	18	20	9
GS00-12-22	3/4	19	12	18	22	9
GS00-12-25	3/4	19	12	19	25	9
GS00-12-32	3/4	19	12	20	32	9
GS00-16-25	1	25.4	16	19	25	9
GS00-16-28	1	25.4	16	20	28	9
GS00-16-30	1	25.4	16	20	30	9
GS00-16-32	1	25.4	16	20	32	9
GS00-16-38	1	25.4	16	26	38	11
GS00-20-30	1.1/4	31.8	20	21	30	9
GS00-20-32	1.1/4	31.8	20	21	32	9
GS00-20-35	1.1/4	31.8	20	23	35	11
GS00-20-38	1.1/4	31.8	20	24	38	11
GS00-24-32	1.1/2	38.1	24	23	32	9
GS00-24-38	1.1/2	38.1	24	23	38	11
GS00-24-42	1.1/2	38.1	24	23	42	10
GS00-24-50	1.1/2	38.1	24	23	50	10
GS00-32-50	2	50.8	32	23	50	10