

VALVOLE OVERCENTER OVERCENTER VALVES

		Descrizione - Description	Type	Page
	NEW!	VALVOLA OVERCENTER A 3 VIE 3 WAY OVERCENTER VALVE	WBC-SE	264
	NEW!	VALVOLA OVERCENTER OVERCENTER VALVE	WBC-SEPI	264 ÷ 265
	NEW!	VALVOLA OVERCENTER OVERCENTER VALVE	WBC-DE	266 ÷ 267
	NEW!	VALVOLA OVERCENTER OVERCENTER VALVE	WBC-SEPI FL	267 ÷ 268
	NEW!	VALVOLA OVERCENTER OVERCENTER VALVE	WBC-DE FL	269
		VALVOLA OVERCENTER OVERCENTER VALVE	VBCD/A SE-FLV	270
		VALVOLA OVERCENTER OVERCENTER VALVE	VBCD/A DE-FLV	270
		VALVOLA OVERCENTER OVERCENTER VALVE	VBCD/A SE	271
		VALVOLA OVERCENTER OVERCENTER VALVE	VBCD/A DE	271
		VALVOLA OVERCENTER OVERCENTER VALVE	VBCD/FL SE	272
		VALVOLA OVERCENTER OVERCENTER VALVE	VBCD/FL DE	272
	NEW!	VALVOLA OVERCENTER PER MOTORI "MPP-MPR-MCP-MCR" OVERCENTER VALVE FOR "MPP-MPR-MCP-MCR" MOTORS	VBCDF SE (MP-MR) VBCDF DE (MP-MR)	273
	NEW!	VALVOLA OVERCENTER PER MOTORI "MPS-MCS" OVERCENTER VALVE FOR "MPS-MCS" MOTORS	VBCDF SE (MS) VBCDF DE (MS)	274

VALVOLE OVERCENTER - OVERCENTER VALVES

WBC-SE

NEW!

SEMPLICE EFFETTO
SINGLE ACTING

VALVOLA OVERCENTER A 3 VIE
3 WAY OVERCENTER VALVE

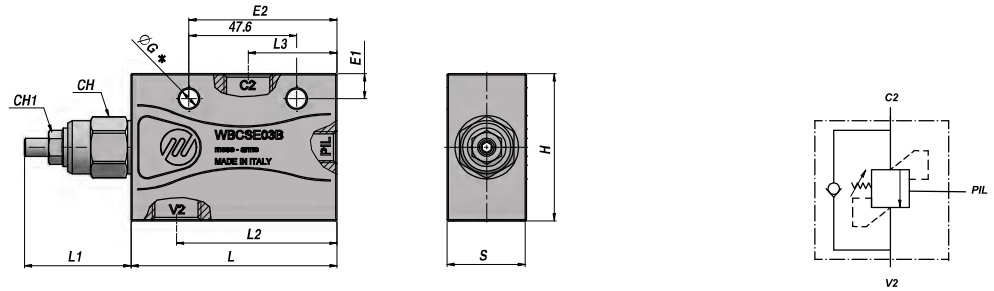
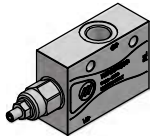

Codice Code	V2 BSP	C2 BSP	PIL BSP	Q MAX l/min	P MAX bar	PILOT RATIO	Tipo Type	L	L1	L2	L3	E1	E2	ØG	CH	CH1	H	S	kg
VSG411.1041B0	1/4"	1/4"	1/4"	40	350	1:4.1	WBC-SE 010 B	84	40	61.0	34.0	7.5	49.0	6.5	22	13	45	25	0,74
VSG411.2042B0	3/8"	3/8"	1/4"	60	350	1:4.2	WBC-SE 020 B	91	47	70.3	39.3	7.0	65.4	8.5	24	13	55	30	1,13
VSG411.3042B0	1/2"	1/2"	1/4"	60	350	1:4.2	WBC-SE 030 B	91	47	70.3	39.3	11.0	65.4	8.5	24	13	65	35	1,53

* = Foro di fissaggio unico per la versione 010 - Single mounting hole for 010 version

MOLLA - SPRING: Type "B" 100-350 bar (Taratura standard - Standard setting 350 bar)

A RICHIESTA - ON REQUEST:

MOLLA - SPRING: Type "A" 60-220 bar (Taratura standard - Standard setting 200 bar)

RAPPORTO DI PILOTAGGIO - PILOT RATIO: 1:8

MATERIALE CORPO : ACCIAIO
BODY MATERIAL : STEEL

MONTAGGIO IN LINEA
LINE MOUNTING

WBC-SEPI

NEW!

SEMPLICE EFFETTO
SINGLE ACTING

VALVOLA OVERCENTER
OVERCENTER VALVE

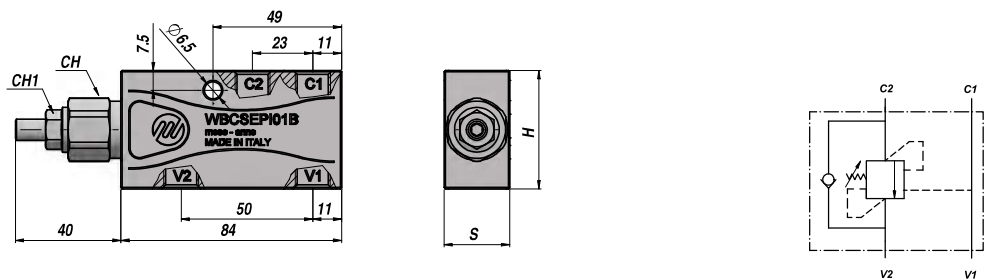
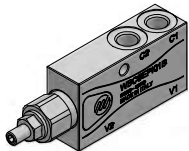

Codice Code	V1-V2 BSP	C1-C2 BSP	M BSP	Q MAX l/min	P MAX bar	PILOT RATIO	Tipo Type	CH	CH1	H	S	kg
VSG410.1041B0	1/4"	1/4"	-	40	350	1:4.1	WBC-SEPI 010 B	22	13	45	25	0,72

MOLLA - SPRING: Type "B" 100-350 bar (Taratura standard - Standard setting 350 bar)

A RICHIESTA - ON REQUEST:

MOLLA - SPRING: Type "A" 60-220 bar (Taratura standard - Standard setting 200 bar)

RAPPORTO DI PILOTAGGIO - PILOT RATIO: 1:8

MATERIALE CORPO : ACCIAIO
BODY MATERIAL : STEEL

MONTAGGIO IN LINEA
LINE MOUNTING

VALVOLA OVERCENTER
OVERCENTER VALVE

SEMPLICE EFFETTO
SINGLE ACTING

NEW!

WBC-SEPI

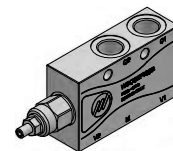
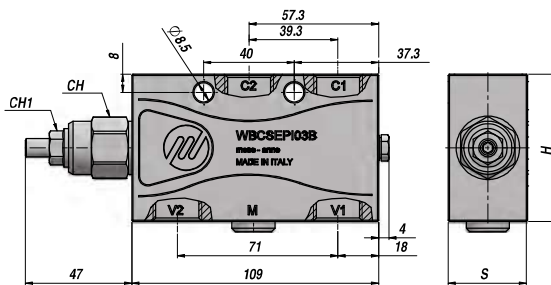
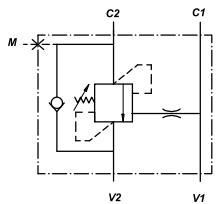

Codice Code	V1-V2 BSP	C1-C2 BSP	M BSP	Q MAX l/min	P MAX bar	PILOT RATIO	Tipo Type	CH	CH1	H	S	kg
VSG410.2042B0	3/8"	3/8"	-	60	350	1:4.2	WBC-SEPI 020 B	24	13	55	30	1,33
VSG410.3042B0	1/2"	1/2"	1/4"	60	350	1:4.2	WBC-SEPI 030 B	24	13	65	35	1,77

MOLLA - SPRING: Type "B" 100-350 bar (Taratura standard - Standard setting 350 bar)

A RICHIESTA - ON REQUEST:

MOLLA - SPRING: Type "A" 60-220 bar (Taratura standard - Standard setting 200 bar)

RAPPORTO DI PILOTAGGIO - PILOT RATIO: 1:8

MATERIALE CORPO : ACCIAIO
BODY MATERIAL : STEEL

MONTAGGIO IN LINEA
LINE MOUNTING

VALVOLA OVERCENTER
OVERCENTER VALVE

SEMPLICE EFFETTO
SINGLE ACTING

NEW!

WBC-SEPI

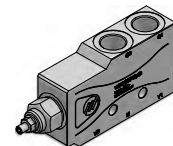
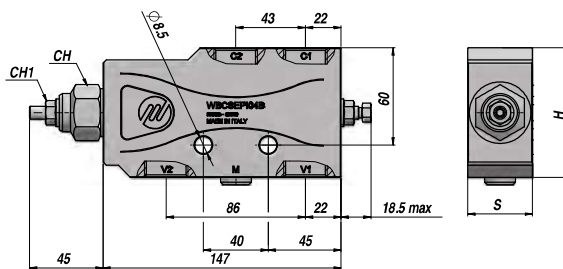
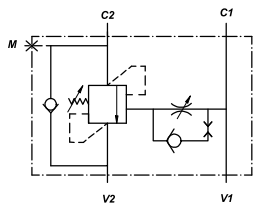

Codice Code	V1-V2 BSP	C1-C2 BSP	M BSP	Q MAX l/min	P MAX bar	PILOT RATIO	Tipo Type	CH	CH1	H	S	kg
VSG410.4040B0	3/4"	3/4"	1/4"	150	350	1:4	WBC-SEPI 040 B	30	13	80	40	3,09

MOLLA - SPRING: Type "B" 100-350 bar (Taratura standard - Standard setting 350 bar)

A RICHIESTA - ON REQUEST:

RAPPORTO DI PILOTAGGIO - PILOT RATIO: 1:6

MATERIALE CORPO : ACCIAIO
BODY MATERIAL : STEEL

MONTAGGIO IN LINEA
LINE MOUNTING

WBC-DE

NEW!

**DOPPIO EFFETTO
DOUBLE ACTING**

**VALVOLA OVERCENTER
OVERCENTER VALVE**

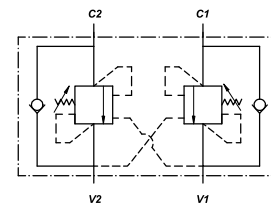
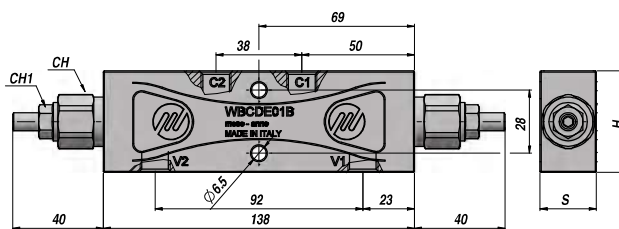
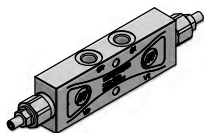

Codice Code	V1-V2 BSP	C1-C2 BSP	M BSP	Q MAX l/min	P MAX bar	PILOT RATIO	Tipo Type	CH	CH1	H	S	kg
VSG412.1042B0	1/4"	1/4"	-	40	350	1:4.1	WBC-DE 010 B	22	13	45	25	1,25

MOLLA - SPRING: Type "B" 100-350 bar (Taratura standard - Standard setting 350 bar)

A RICHIESTA - ON REQUEST:

MOLLA - SPRING: Type "A" 60-220 bar (Taratura standard - Standard setting 200 bar)

RAPPORTO DI PILOTAGGIO - PILOT RATIO : 1:8

MATERIALE CORPO : ACCIAIO
BODY MATERIAL : STEEL

MONTAGGIO IN LINEA
LINE MOUNTING

WBC-DE

NEW!

**DOPPIO EFFETTO
DOUBLE ACTING**

**VALVOLA OVERCENTER
OVERCENTER VALVE**

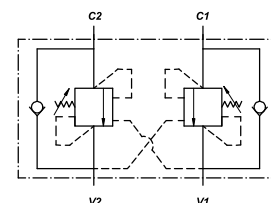
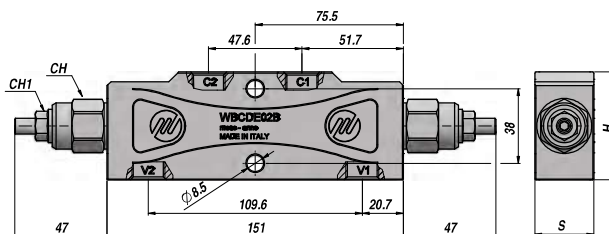
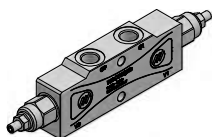

Codice Code	V1-V2 BSP	C1-C2 BSP	M BSP	Q MAX l/min	P MAX bar	PILOT RATIO	Tipo Type	CH	CH1	H	S	kg
VSG412.2042B0	3/8"	3/8"	-	60	350	1:4.2	WBC-DE 020 B	24	13	55	30	1,85
VSG412.3042B0	1/2"	1/2"	-	60	350	1:4.2	WBC-DE 030 B	24	13	65	35	2,50

MOLLA - SPRING: Type "B" 100-350 bar (Taratura standard - Standard setting 350 bar)

A RICHIESTA - ON REQUEST:

MOLLA - SPRING: Type "A" 60-220 bar (Taratura standard - Standard setting 200 bar)

RAPPORTO DI PILOTAGGIO - PILOT RATIO : 1:8

MATERIALE CORPO : ACCIAIO
BODY MATERIAL : STEEL

MONTAGGIO IN LINEA
LINE MOUNTING

VALVOLA OVERCENTER
OVERCENTER VALVE

DOPPIO EFFETTO
DOUBLE ACTING

NEW!

WBC-DE

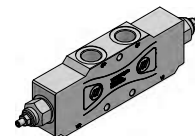
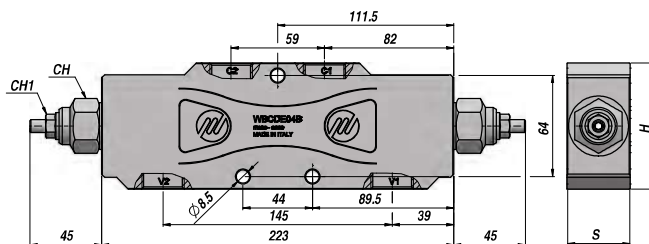
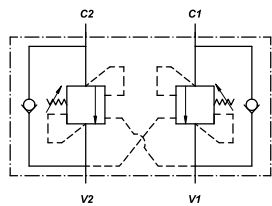

Codice Code	V1-V2 BSP	C1-C2 BSP	M BSP	Q MAX l/min	P MAX bar	PILOT RATIO	Tipo Type	CH	CH1	H	S	kg
VSG412.4040B0	3/4"	3/4"	-	150	350	1:4	WBC-DE 040 B	30	13	80	40	4,86

MOLLA - SPRING: Type "B" 100-350 bar (Taratura standard - Standard setting 350 bar)

A RICHIESTA - ON REQUEST:
RAPPORTO DI PILOTAGGIO - PILOT RATIO : 1:6

MATERIALE CORPO : ACCIAIO
BODY MATERIAL : STEEL

MONTAGGIO IN LINEA
LINE MOUNTING

VALVOLA OVERCENTER
OVERCENTER VALVE

SEMPLICE EFFETTO
SINGLE ACTING

NEW!

WBC-SEPI/FL

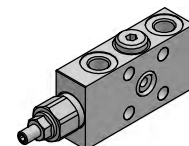
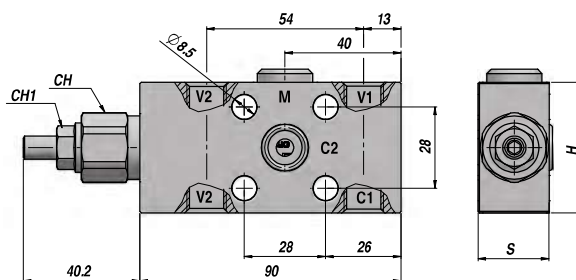
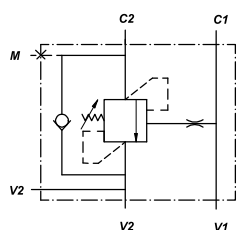

Codice Code	V1-V2 BSP	C1 BSP	C2	M BSP	Q MAX l/min	P MAX bar	PILOT RATIO	Tipo Type	CH	CH1	H	S	kg
VSG420.1041B0	1/4"	1/4"	Ø6	1/4"	40	350	1:4.1	WBC-SEPI-FL 010 B	22	13	45	24.5	0,72

MOLLA - SPRING: Type "B" 100-350 bar (Taratura standard - Standard setting 350 bar)

A RICHIESTA - ON REQUEST:
MOLLA - SPRING: Type "A" 60-220 bar (Taratura standard - Standard setting 200 bar)
RAPPORTO DI PILOTAGGIO - PILOT RATIO : 1:8

MATERIALE CORPO : ACCIAIO
BODY MATERIAL : STEEL

FLANGIABILE
FACE MOUNTING

WBC-SEPI/FL

NEW!

SEMPLICE EFFETTO
SINGLE ACTING

VALVOLA OVERCENTER
OVERCENTER VALVE

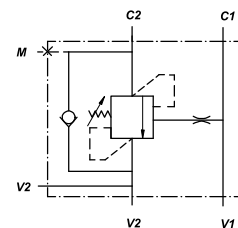
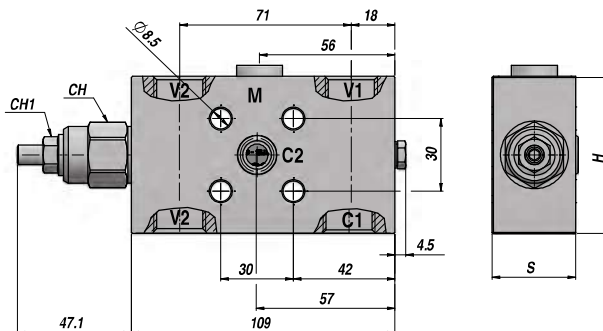
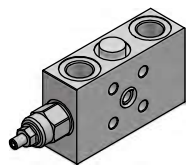

Codice Code	V1-V2 BSP	C1 BSP	C2	M BSP	Q MAX l/min	P MAX bar	PILOT RATIO	Tipo Type	CH	CH1	H	S	kg
VSG420.2042B0	3/8"	3/8"	Ø9	1/4"	60	350	1:4.2	WBC-SEPI-FL 020 B	24	13	55	29.5	1,30
VSG420.3042B0	1/2"	1/2"	Ø9	1/4"	60	350	1:4.2	WBC-SEPI-FL 030 B	24	13	65	34.5	1,75

MOLLA - SPRING : Type "B" 100-350 bar (Taratura standard - Standard setting 350 bar)

A RICHIESTA - ON REQUEST :

MOLLA - SPRING : Type "A" 60-220 bar (Taratura standard - Standard setting 200 bar)

RAPPORTO DI PILOTAGGIO - PILOT RATIO : 1:8

MATERIALE CORPO : ACCIAIO
BODY MATERIAL : STEEL

FLANGIABILE
FACE MOUNTING

WBC-SEPI/FL

NEW!

SEMPLICE EFFETTO
SINGLE ACTING

VALVOLA OVERCENTER
OVERCENTER VALVE

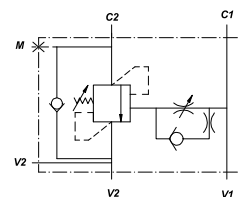
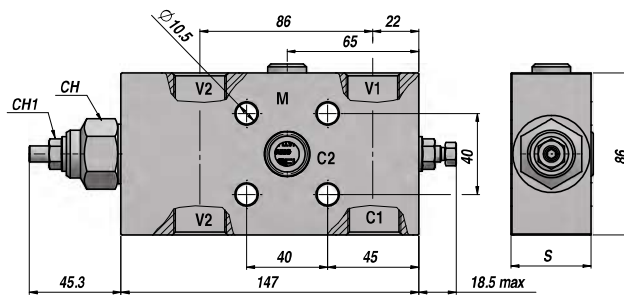
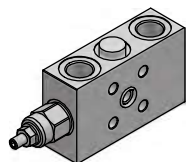

Codice Code	V1-V2 BSP	C1 BSP	C2	M BSP	Q MAX l/min	P MAX bar	PILOT RATIO	Tipo Type	CH	CH1	H	S	kg
VSG420.4040B0	3/4"	3/4"	Ø12	1/4"	150	350	1:4	WBC-SEPI-FL 040 B	30	13	80	39.5	3,00

MOLLA - SPRING : Type "B" 100-350 bar (Taratura standard - Standard setting 350 bar)

A RICHIESTA - ON REQUEST :

RAPPORTO DI PILOTAGGIO - PILOT RATIO : 1:6

MATERIALE CORPO : ACCIAIO
BODY MATERIAL : STEEL

FLANGIABILE
FACE MOUNTING

VALVOLA OVERCENTER
OVERCENTER VALVE

DOPPIO EFFETTO
DOUBLE ACTING

NEW!

WBC-DE/FL

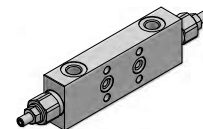
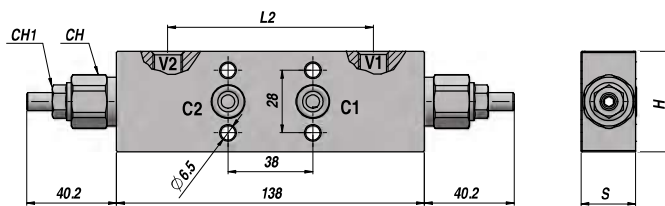
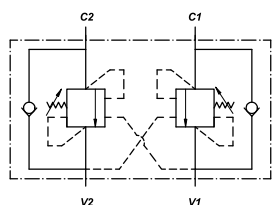

Codice Code	V1-V2 BSP	C1-C2	M	Q MAX l/min	P MAX bar	PILOT RATIO	Tipo Type	L2	CH	CH1	H	S	kg
VSG422.1042B0	1/4"	Ø6	-	40	350	1:4.1	WBC-DE-FL 010 B	92	22	13	45	24.5	1,20

MOLLA - SPRING : Type "B" 100-350 bar (Taratura standard - Standard setting 350 bar)

A RICHIESTA - ON REQUEST :

MOLLA - SPRING : Type "A" 60-220 bar (Taratura standard - Standard setting 200 bar)

RAPPORTO DI PILOTAGGIO - PILOT RATIO : 1:8

MATERIALE CORPO : ACCIAIO
BODY MATERIAL : STEEL

FLANGIABILE
FACE MOUNTING

VALVOLA OVERCENTER
OVERCENTER VALVE

DOPPIO EFFETTO
DOUBLE ACTING

NEW!

WBC-DE/FL

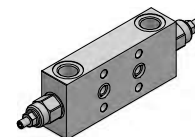
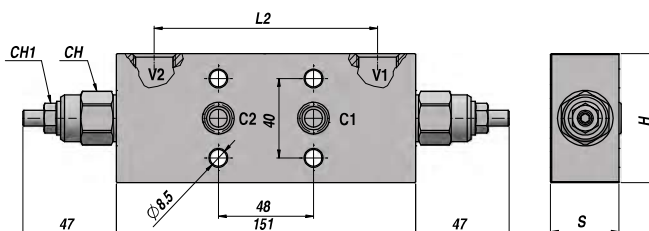
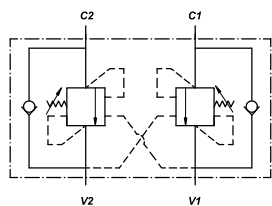

Codice Code	V1-V2 BSP	C1-C2	M	Q MAX l/min	P MAX bar	PILOT RATIO	Tipo Type	L2	CH	CH1	H	S	kg
VSG422.2042B0	3/8"	Ø9	-	60	350	1:4.2	WBC-DE-FL 020 B	109.6	24	13	54.5	29.5	1,80
VSG422.3042B0	1/2"	Ø9	-	60	350	1:4.2	WBC-DE-FL 030 B	112.6	24	13	65.0	34.5	2,40

MOLLA - SPRING : Type "B" 100-350 bar (Taratura standard - Standard setting 350 bar)

A RICHIESTA - ON REQUEST :

MOLLA - SPRING : Type "A" 60-220 bar (Taratura standard - Standard setting 200 bar)

RAPPORTO DI PILOTAGGIO - PILOT RATIO : 1:8

MATERIALE CORPO : ACCIAIO
BODY MATERIAL : STEEL

FLANGIABILE
FACE MOUNTING

VBCD/A SE-FLV

SEMPLICE EFFETTO
SINGLE ACTING

VALVOLA OVERCENTER
OVERCENTER VALVE

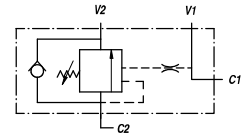
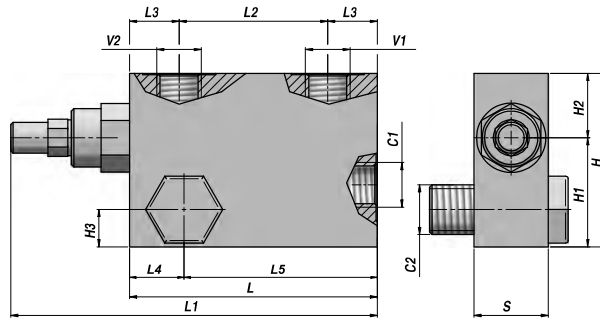
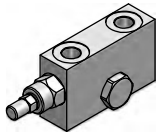

Codice Code	V1 - V2 BSP	C1 - C2 BSP	Q MAX l/min	P MAX bar	PILOT RATIO	Tipo Type	L	L1	L2	L3	L4	L5	H1	H2	H3	H	S	kg
V2190.0392FLV	3/8"	3/8"	40	350	1:4.5	VBCD/A SE-FLV 3/8"	100	150	60	20	22	78	40	30	15	70	30	1,35
V2190.0412FLV	1/2"	1/2"	60	350	1:4.5	VBCD/A SE-FLV 1/2"	100	150	60	20	24	76	40	30	15	70	30	1,31

Taratura standard - Standard setting : 320 bar

Taratura minima - Minimum setting : 200 bar

MATERIALE CORPO : ACCIAIO
BODY MATERIAL : STEEL

MONTAGGIO SU CILINDRO
CYLINDER MOUNTING

VBCD/A DE-FLV

DOPPIO EFFETTO
DOUBLE ACTING

VALVOLA OVERCENTER
OVERCENTER VALVE

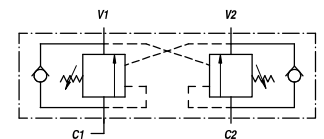
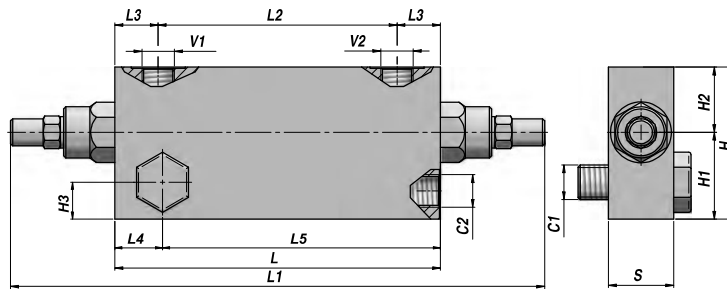
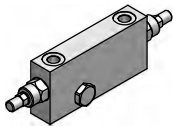

Codice Code	V1 - V2 BSP	C1 - C2 BSP	Q MAX l/min	P MAX bar	PILOT RATIO	Tipo Type	L	L1	L2	L3	L4	L5	H1	H2	H3	H	S	kg
V2290.0422FLV	3/8"	3/8"	40	350	1:4.5	VBCD/A DE-FLV 3/8"	150	250	110	20	22	128	44	26	17	70	30	2,41
V2290.0432FLV	1/2"	1/2"	60	350	1:4.5	VBCD/A DE-FLV 1/2"	150	250	110	20	24	126	50	30	19	80	30	2,70

Taratura standard - Standard setting : 320 bar

Taratura minima - Minimum setting : 200 bar

MATERIALE CORPO : ACCIAIO
BODY MATERIAL : STEEL

MONTAGGIO SU CILINDRO
CYLINDER MOUNTING

VALVOLA OVERCENTER
OVERCENTER VALVE

SEMPLICE EFFETTO
SINGLE ACTING

VBCD/A SE

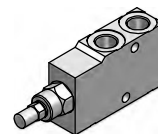
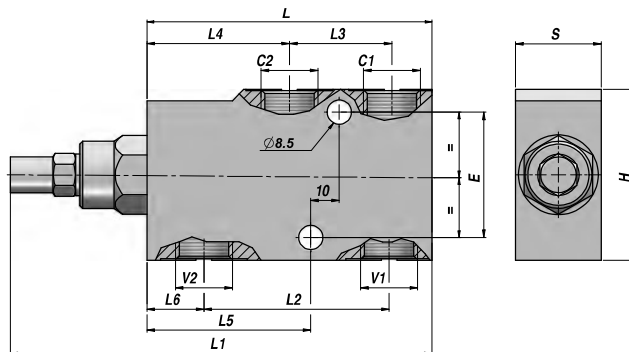
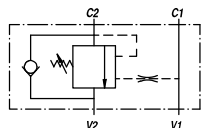

Codice Code	V1 - V2 BSP	C1 - C2 BSP	Q MAX l/min	P MAX bar	PILOT RATIO	Tipo Type	L	L1	L2	L3	L4	L5	L6	E	H	S	kg
V2190.A400	1/4"	1/4"	20	350	1:4.5	VBCD/A SE 1/4"	100	149	60.0	30	50.0	55.0	20.0	44	60	30	1,31
V2190.A600	3/8"	3/8"	40	350	1:4.5	VBCD/A SE 3/8"	100	149	60.0	30	50.0	55.0	20.0	44	60	30	1,26
V2190.A800	1/2"	1/2"	60	350	1:4.5	VBCD/A SE 1/2"	100	149	65.0	36	50.0	57.5	20.0	44	60	30	1,20
V2190.A120	3/4"	3/4"	95	350	1:5.5	VBCD/A SE 3/4"	127	187	85.0	46	62.5	75.0	23.5	44	80	35	2,37
V2190.A160	1"	1"	160	350	1:5.5	VBCD/A SE 1"	156	213	109.5	70	63.0	75.0	23.5	70	90	50	5,52

Taratura standard - Standard setting : 320 bar

Taratura minima - Minimum setting : 200 bar

MATERIALE CORPO : ACCIAIO
BODY MATERIAL : STEEL

MONTAGGIO IN LINEA
LINE MOUNTING

VALVOLA OVERCENTER
OVERCENTER VALVE

DOPPIO EFFETTO
DOUBLE ACTING

VBCD/A DE

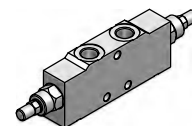
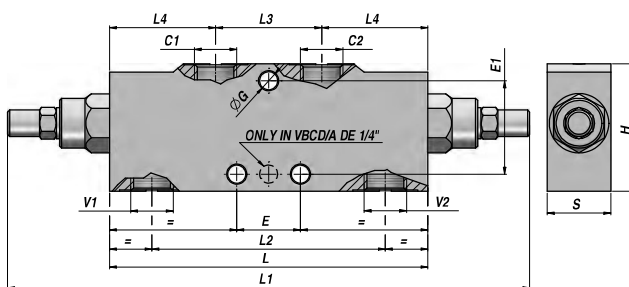
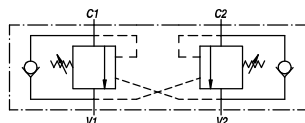

Codice Code	V1 - V2 BSP	C1 - C2 BSP	Q MAX l/min	P MAX bar	PILOT RATIO	Tipo Type	L	L1	L2	L3	L4	ØG	E	E1	H	S	kg
V2290.A400	1/4"	1/4"	20	350	1:4.5	VBCD/A DE 1/4"	125	237	94	38	43.5	6.5	-	28	55	30	1,07
V2290.A600	3/8"	3/8"	40	350	1:4.5	VBCD/A DE 3/8"	150	248	110	50	50.0	8.5	30	44	60	30	1,94
V2290.A800	1/2"	1/2"	60	350	1:4.5	VBCD/A DE 1/2"	150	248	110	50	50.0	8.5	30	44	60	30	1,89
V2290.A120	3/4"	3/4"	95	350	1:5.5	VBCD/A DE 3/4"	190	304	143	65	62.5	8.5	44	64	80	35	3,82
V2290.A160	1"	1"	160	350	1:5.5	VBCD/A DE 1"	210	319	158	66	72.0	8.5	190	-	90	50	7,12

Taratura standard - Standard setting : 320 bar

Taratura minima - Minimum setting : 200 bar

MATERIALE CORPO : ACCIAIO
BODY MATERIAL : STEEL

MONTAGGIO IN LINEA
LINE MOUNTING

VBCD/FL SE

SEMPLICE EFFETTO
SINGLE ACTING

VALVOLA OVERCENTER
OVERCENTER VALVE

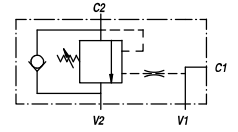
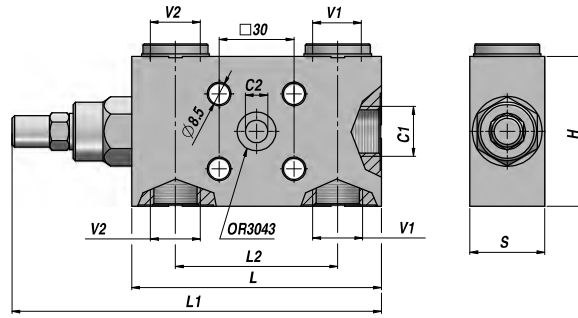
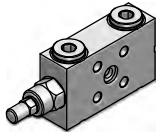

Codice Code	V1 - V2 BSP	C1 BSP	C2	Q MAX l/min	P MAX bar	PILOT RATIO	Tipo Type	L	L1	L2	H	S	kg
V2190.B600	3/8"	3/8"	Ø9	40	350	1:4.5	VBCD/FL SE 3/8"	100	149	60	60	30	1,25
V2190.B800	1/2"	1/2"	Ø9	60	350	1:4.5	VBCD/FL SE 1/2"	100	149	65	60	30	1,21

Taratura standard - Standard setting : 320 bar Taratura minima - Minimum setting : 200 bar

MATERIALE CORPO : ACCIAIO FLANGIABILE
BODY MATERIAL : STEEL FACE MOUNTING

Basetta per VBCD...FL/SE - Sub-plate for VBCD...FL/SE

Codice Code	Tipo Type
V9990.8000	B8000 - 45x45x25

MATERIALE - MATERIAL : ACCIAIO - STEEL

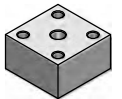
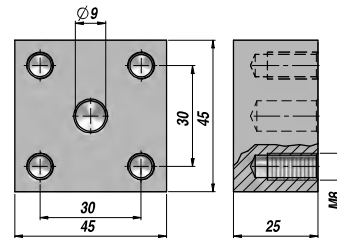

VBCD/FL DE

DOPPIO EFFETTO
DOUBLE ACTING

VALVOLA OVERCENTER
OVERCENTER VALVE

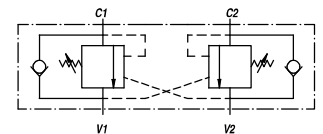
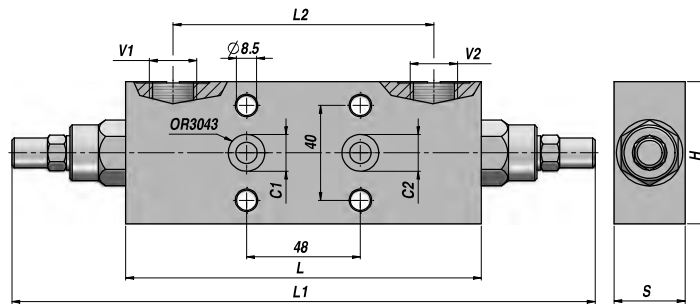
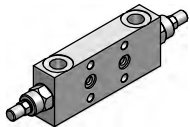

Codice Code	V1 - V2 BSP	C1 - C2	Q MAX l/min	P MAX bar	PILOT RATIO	Tipo Type	L	L1	L2	H	S	kg
V2290.B600	3/8"	Ø9	40	350	1:4.5	VBCD/FL DE 3/8"	150	248	110	60	30	2,01
V2290.B800	1/2"	Ø9	60	350	1:4.5	VBCD/FL DE 1/2"	150	248	110	60	30	1,98

Taratura standard - Standard setting : 320 bar Taratura minima - Minimum setting : 200 bar

MATERIALE CORPO : ACCIAIO FLANGIABILE
BODY MATERIAL : STEEL FACE MOUNTING

Basetta per VBCD...FL/DE - Sub-plate for VBCD...FL/DE

Codice Code	Tipo Type
V9990.8500	B8500 - 100x55x25

MATERIALE - MATERIAL : ACCIAIO - STEEL

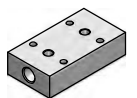
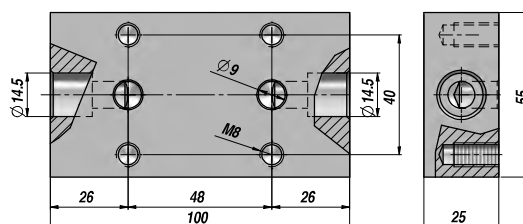

VBCDF-SE (MS)

SEMPLICE EFFETTO
SINGLE ACTING

VALVOLA OVERCENTER PER MOTORI MPS-MCS
OVERCENTER VALVE FOR "MPS-MCS" MOTORS

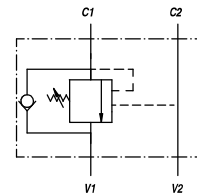
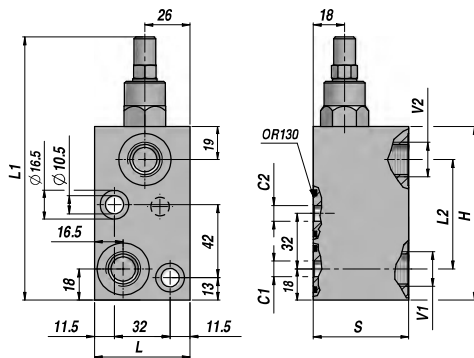
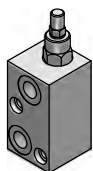

Codice Code	V1 - V2 BSP	C1 - C2	Q MAX l/min	P MAX bar	PILOT RATIO	Tipo Type	L	L1	L2	H	S	kg
V2190.F416	1/2"	Ø9	50	350	1:4.5	VBCDF-SE 1/2"-S	55	148	63	100	55	1,70

Taratura standard - Standard setting : 320 bar

Taratura minima - Minimum setting : 200 bar

A RICHIESTA - ON REQUEST:

VBCDF/SF-SE ...CON SBLOCCO FRENO - WITH BRAKE RELEASE PORT

MATERIALE CORPO : ACCIAIO
BODY MATERIAL : STEEL

FLANGIABILE
FACE MOUNTING

VBCDF-DE (MS)

DOPPIO EFFETTO
DOUBLE ACTING

VALVOLA OVERCENTER PER MOTORI MPS-MCS
OVERCENTER VALVE FOR "MPS-MCS" MOTORS

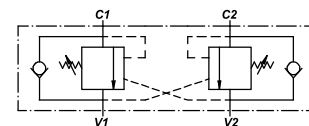
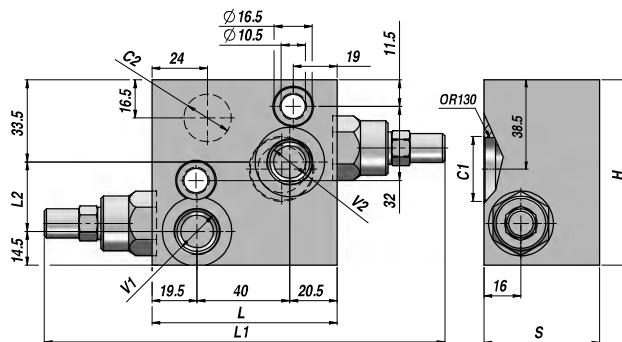
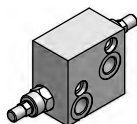

Codice Code	V1 - V2 BSP	C1 - C2	Q MAX l/min	P MAX bar	PILOT RATIO	Tipo Type	L	L1	L2	H	S	kg
V2290.F426	1/2"	Ø9	50	350	1:4.5	VBCDF-DE 1/2"-S	80	170	30	80	50	2,15

Taratura standard - Standard setting : 320 bar

Taratura minima - Minimum setting : 200 bar

A RICHIESTA - ON REQUEST:

VBCDF/SF-DE ...CON SBLOCCO FRENO - WITH BRAKE RELEASE PORT

MATERIALE CORPO : ACCIAIO
BODY MATERIAL : STEEL

FLANGIABILE
FACE MOUNTING