



# INTERPUMP

FLUID SOLUTIONS 

Powered by I.M.M. Hydraulics

## Fittings

2023



# Fittings

Standard Tail

N Tail

Interlock Tail

Hyblast / Multispiral Tail

Low Pressure Fittings



Standard Tail





**001C**



Swaged Ferrule (no skive)

**11**

**002Z**



Swaged Ferrule (no skive)

**12**

**012N**



Swaged Ferrule

**13**

**0001**



Swaged Ferrule (skive)

**14**

**0002**



Swaged Ferrule (skive)

**15**



**0009**



Swaged Ferrule (skive)

**16**

**004H**



Swaged Ferrule (skive)

**16**

**OSI4**



Swaged Ferrule (skive)

**17**

**BMC1**



Swaged Ferrule (no skive)

**17**

**BMC2**



Swaged Ferrule (no skive)

**18**



**0007**



Swaged Ferrule (no skive)

**18**

**0008**



Swaged Ferrule (no skive)

**19**



**0003**



Swaged Ferrule (no skive)

**19**



**PTFE**



Ferrule for PTFE hose

**20**

**PTFE-C**



Ferrule for PTFE hose

**20**



**0345**



BSP Male Flat Seat

**21**

**0060**



BSP Female flat seat

**22**



**0350**



BSP Male Parallel 60° cone

**23**

**035G**



BSP Male Parallel 60° Cone - Rotating

**24**

**0050**



BSP Female 60° cone Thrust Wire

**25**

**0051**



BSP Female 60° Cone - Rolled Nut

**25**

**0058**



BSP Female 60° Cone Slip On Nut

**25**

**0051D**



BSP Female 60° Cone - Double Hexagon

**26**

**0150**



BSP Swept Elbow 60° Cone-Thrust wire Nut

**27**

**0151**



BSP 90° Swept Elbow 60° Cone - Rolled Nut

**27**

**0158**



BSP 90° Swept elbow 60° cone Slip On Nut

**27**

**0250**



BSP Swept Elbow 60° Cone-Thrust wire Nut

**28**

**0251**



BSP 45° Swept Elbow 60° Cone Rolled nut

**28**

**0258**



BSP 45° Swept Elbow 60° Cone Slipse on nut

**28**

**2321**



BSP 90° Compact Elbow 60° Cone - Rolled nut

**29**

**2300**



BSP 90° Compact Elbow 60° Cone - Thrust wire - Welded

**29**

**0041**



BSP O'Ring Female 60° Cone-Thrust wire Nut

**30**

**0048**



BSP O'Ring Female 60° Cone - Slip on nut

**30**

**0141**



BSP O'Ring 90° Swept elbow 60° cone Rolled Nut

**31**

**0148**



BSP O'Ring 90° Swept elbow 60° cone- Slip on nut

**31**

**0241**



BSP O'Ring 45° Swept Elbow 60° Cone - Rolled nut

**32**

**0248**



BSP O'Ring 45° Swept Elbow 60° Cone - Slip on nut

**32**



**0360**



BSP Taper Male 60° cone

**33**



**0370**



NPTF Male 60° cone

**34**



**037G**



NPTF Male Parallel 60°  
Cone - Rotating

**35**

**N051**



NPSM Female 60° Cone  
Rolled Nut

**35**



**0850**



JIC Male 74° cone

**36**

**0900**



JIC Female 74° - Thrust  
Wire Nut

**37**

**0901**



JIC Female 74° cone -  
Rolled Nut

**37**

**0902**



JIC Female 74° - Slip on  
nut

**37**

**0901D**



JIC Female 74° Cone-  
Double Hexagon

**38**

**0950**



JIC 90° Swept Elbow 74°  
Cone - Thrust Wire

**39**

**0951**



JIC 90° Swept Elbow 74°  
cone - Rolled Nut

**39**

**0952**



JIC 90° Swept Elbow 74°  
cone - Slip on nut

**39**

**1000**



JIC 45° Swept Elbow 74°  
Cone Thrust Wire Nut

**40**

**1001**



JIC 45° Swept Elbow 74°  
cone - Rolled Nut

**40**

**1002**



JIC 45° Swept Elbow 74°  
Cone Slipse on nut

**40**

**095S**



JIC 90° Swept Elbow 74°  
cone - ISO SHORT

**41**

**2971**



JIC 90° Compact Elbow  
74° cone - Crimped Nut

**41**



**0385**



SAE Male O'R Flat Seat

**42**



**0500**



Metric Male 24° Seat Light

**43**

**0085**



Metric Female 24° Seat Light

**44**

**0185**



90° Metric Swept Elbow 24° Seat Light

**45**

**0285**



45° Metric Swept Elbow 24° Seat Light

**46**



**0450**



Metric Male 24° Seat Heavy

**47**

**0084**



Metric Female 24° Seat Heavy

**48**

**0184**



90° Metric Swept Elbow 24° Seat Heavy

**49**

**0284**



45° Metric Swept Elbow 24° Seat Heavy

**50**



**0550**



Metric Standpipe

**51**

**0650**



90° Metric Standpipe

**52**

**0650S**



Female Metric Tubular 90° (welded)

**52**

**0750**



45° Metric Standpipe

**53**

**0750S**



45° Metric Standpipe  
(welded)

**53**



**0035**



Metric Female 24° Seat  
Light Multiseal

**54**

**0135**



90° Metric Swept Elbow  
24° Seat Light Multiseal

**55**



**0400**



Metric Male 60° cone

**56**

**0100**



Metric Female 60° cone

**57**

**0200**



90° Metric Swept Elbow  
60° cone

**58**



**S350**



ORFS Male

**59**

**S050**



ORFS Female

**60**

**S05T**



ORFS Female Back  
Hexagon

**61**

**S150**



ORFS 90° Swept Elbow

**62**

**S15S**



ORFS 90° Swept Elbow -  
ISO SHORT

**63**

**S250**



ORFS 45° Swept Elbow

**64**



**1260**



Straight SAE Flange  
3000 PSI

**65**

**1060**



90° SAE Flange 3000 PSI

**66**

**1160**



45° SAE Flange 3000 PSI

**67**

**FS3L**



90° SAE Flange 3000 Psi  
- Long Drop

**67**

**S003**



Cut Split Flanges - 3000  
psi

**68**



**1310**



Straight SAE Flange  
6000 PSI

**69**

**1110**



90° SAE Flange 6000 PSI

**70**

**1210**



45° SAE Flange 6000 PSI

**71**

**FS6L**



90° SAE Flange 6000 Psi  
- Long Drop

**71**

**S006**



Cut Split Flanges - 6000  
psi

**72**



**130S**



Straight 'CAT' Flange

**72**

**110S**



90° 'CAT' Flange

**73**

**120S**



45° 'CAT' Flange

**73**



**1250**



Komatsu Flange -  
Straight

**74**

**1050**



Komatsu Flange 90°

**74**

**1150**



Komatsu Flange 45°

**74**

**0940**



JIS Female 60° Cone  
(Komatsu)

**75**

**0990S**



90° JIS Swept Elbow  
(Komatsu) - welded

**76**



**0930**



JIS Female 60° cone  
(Toyota)

**76**

**0980S**



90° JIS Swept Elbow  
(Toyota) - welded

**77**



**0920**



JIS Female 60° cone  
(Nissan)

**77**



**0030**



Metric Female 24° Cone  
French Type

**78**



**FK50**



'K' Female

**78**

**FN50**



'K' Male ( for gun) -  
Diameter 10

**79**

**FN51**



'K' Male ( for gun) -  
Diameter 11

**79**



**1400**



BSP Banjo

**80**

**1600**



Double BSP Perforated  
Bolt

**81**

**1600-00**



BSP Perforated Bolt

**81**

**1350**



Metric Banjo

**82**

**1650**



Metric perforated bolt

**83**



**D050**



Hose Junction

**84**



**GS00**



Weldable Fitting

**85**

## 001C

## Swaged Ferrule (no skive)

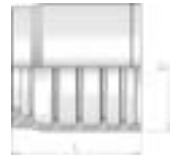

Product number	hose I.D.		Dimension		skive Length	valid for -
	in	mm	D	L		
001C-03	3/16	4,8	18,5	24	NO	R17-2SC-1SN-Pilot-H1
001C-04	1/4	6,4	20	26	NO	R17-2SC-1SC-1SN-Pilot-H1
001C-05	5/16	7,9	22	28	NO	R17-2SC-1SC-1SN-Pilot-H1
001C-06	3/8	9,5	25	28	NO	R17-2SC-1SC-1SN-Pilot-H1
001C-08	1/2	12,7	28	28	NO	R17-2SC-1SC-1SN-Pilot-H1
001C-10	5/8	15,9	32	31	NO	R17-2SC-1SC-1SN-H1
001C-12	3/4	19	36	38	NO	R17-2SC-1SC-1SN-H1
001C-16	1	25,4	44	47,5	NO	R17-2SC-1SC-1SN-H1
001C-20	1.1/4	31,8	54	56	NO	1SN-2SC-1SC
001C-24	1.1/2	38,1	61,6	66	NO	1SN-2SC-1SC
001C-32	2	50,8	75,4	73	NO	1SN-2SC-1SC
001C-40	2.1/2	63,5	88,4	80	NO	2SC-1SC
001C-48	3	76,2	100,5	90	NO	2SC-1SC

## 0022



### Swaged Ferrule (no skive)

Product number	hose I.D.	I.D.	Dimension		skive	valid for
	in	mm	D	L	Length	-
0022-03	3/16	4.8	21	25.3	NO	25N-(15N)
0022-04	1/4	6.4	22	28	NO	25N-(15N)
0022-05	5/16	7.9	24	28	NO	25N-(15N)
0022-06	3/8	9.5	26	28	NO	25N-(15N)
0022-08	1/2	12.7	30	31	NO	25N-(15N)
0022-10	5/8	15.9	34	31	NO	25N-(15N)
0022-12	3/4	19	38	38.5	NO	25N-(15N)
0022-16	1	25.4	47	48	NO	25N-(15N)
0022-20	1.1/4	31.8	58	56	NO	25N-(15N)
0022-24	1.1/2	38.1	66	66	NO	25N-(15N)
0022-32	2	50.8	79	73	NO	25N-(15N)



**012N****Swaged Ferrule**

Product number	hose I.D.	I.D.	Dimension		skive	valid for
	in	mm	D	L	Length	
012N-04	1/4	6.4	18.3	28	21	ONE 1RN-TWO 2RN-2MC-2SC
012N-05	5/16	7.9	20.0	29	22	ONE 1RN-TWO 2RN-2MC-2SC
012N-06	3/8	9.5	22.8	30	23	ONE 1RN-TWO 2RN-2MC-2SC
012N-08	1/2	12.7	26.3	32	24	ONE 1RN-TWO 2RN-2MC-2SC
012N-10	5/8	15.9	29.8	34	26	ONE 1RN-TWO 2RN-2MC-2SC
012N-12	3/4	19	34.4	40	31	ONE 1RN-TWO 2RN-2MC-2SC
012N-16	1	25.4	42.9	49	38	ONE 1RN-TWO 2RN-2MC-2SC
012N-20	1.1/4	31.8	52.5	56	43	TWO 2RN
012N-24	1.1/2	38.1	59.2	63	49	TWO 2RN
012N-32	2	50.8	72.2	73	58	TWO 2RN

## 0001

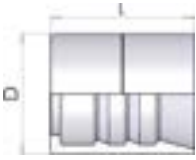

## Swaged Ferrule (skive)

Product number	hose I.D.	I.D.	Dimension		skive	valid for
	in	mm	D	L	Length	-
0001-03	3/16	4.8	17.5	27	20	1SN-(2SC-1ST)
0001-04	1/4	6.4	20	30.2	23	1SN-(2SC-1ST)
0001-05	5/16	7.9	22	30.7	23	1SN-(2SC-1ST)
0001-06	3/8	9.5	24	32	24	1SN-(2SC-1ST)
0001-08	1/2	12.7	28.5	34	25	1SN-(2SC-1ST)
0001-10	5/8	15.9	32	37	27	1SN-(2SC-1ST)
0001-12	3/4	19	36	43	31	1SN-(2SC-1ST)
0001-16	1	25.4	43	50	37	1SN-(2SC-1ST)
0001-20	1.1/4	31.8	52	57	46	1SN-(2SC-1ST)
0001-24	1.1/2	38.1	57	63	44	1SN-(2SC-1ST)
0001-32	2	50.8	70.6	78	60	1SN-(2SC-1ST)

0002

## Swaged Ferrule (skive)

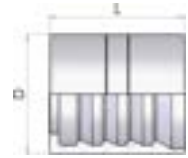

Product number	hose I.D.		I.D.		Dimension		skive	valid for
	in	mm	D	L	Length	-		
0002-03	3/16	4.8	20	27	21	25N-(2ST)		
0002-04	1/4	6.4	21	30	22	25N-(2ST)		
0002-05	5/16	7.9	24	30	22	25N-(2ST)		
0002-06	3/8	9.5	25.4	32	24	25N-35C-(2ST)		
0002-08	1/2	12.7	30	34	25	25N-(2ST)		
0002-10	5/8	15.9	34	37	27	25N-(2ST)		
0002-12	3/4	19	38	43	31	25N-(2ST)		
0002-16	1	25.4	46	50	37	25N-(2ST)		
0002-20	1.1/4	31.8	56	59	43	25N-(2ST)		
0002-24	1.1/2	38.1	62	63	45	25N-(2ST)		
0002-32	2	50.8	75	79	61	25N-(2ST)		
0002-40	2.1/2	63.5	95	83.7	63	25N-(2ST)		
0002-48	3	76.2	105.6	94.3	78	25N-(2ST)		

## 0009

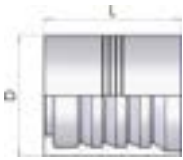

### Swaged Ferrule (skive)

Product number	hose I.D.	Dimension		I.D.	skive	valid for
	in	D	mm	L	Length	
0009-04	1/4	21	6.4	30	22	4SP-R12
0009-06	3/8	25.4	9.5	33.5	26	4SP-R12
0009-08	1/2	30	12.7	36	28	4SP-R12
0009-10	5/8	34	15.9	40	31	4SP-R12
0009-12	3/4	38	19	43	34	4SP-(R12-4SH)
0009-16	1	46	25.4	60	48	(4SP-R12)
0009-20	1.1/4	56	31.8	66	54	(4SP-R12)
0009-24	1.1/2	67	38.1	76.5	62	(4SP-R12)
0009-32	2	80	50.8	79.8	64	4SP

## 004H

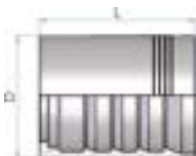

### Swaged Ferrule (skive)

Product number	hose I.D.	I.D.	Dimension		skive	valid for
	in	mm	D	L	Length	
004H-20	1.1/4	31.8	52	66	55	(4SH)
004H-24	1.1/2	38.1	62	76.5	63	(4SH)
004H-32	2	50.8	75	79.8	65	R12

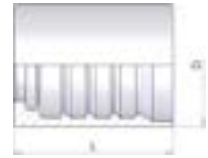
**OSI4****Swaged Ferrule (skive)**

Product number	hose I.D.	I.D.	Dimension		skive	valid for
	in	mm	D	L	Length	
OSI4-06	3/8	9.5	24	31	23	Four SP - Hysoflex 4K - Hysoflex 5K - Hysoflex 6K
OSI4-08	1/2	12.7	27.6	33	24.5	Four SP - Hysoflex 4K - Hysoflex 5K - Hysoflex 6K
OSI4-10	5/8	15.9	32	36	27.5	Four SP - Hysoflex 4K
OSI4-12	3/4	19	36.4	42	32.5	Four SP - Hysoflex 4K
OSI4-16	1	25.4	44	55.5	44	Four SP - Hysoflex 4K

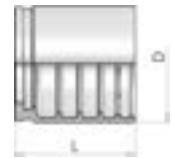
**BMC1****Swaged Ferrule (no skive)**

Product number	hose I.D.	I.D.	Dimension		skive	valid for
	in	mm	D	L	Length	
BMC1-12	3/4	19	45	41	NO	R12
BMC1-16	1	25.4	53.5	56	NO	R12-4SP-4SH
BMC1-20	1.1/4	31.8	62	62	NO	(4SH)

## BMC2



### Swaged Ferrule (no skive)

Product number	hose I.D.	I.D.	Dimension		skive	valid for
	in	mm	D	L	Length	-
BMC2-20	1.1/4	31.8	66	62	NO	R12-4SP
BMC2-24	1.1/2	38.1	73.3	70	NO	R12-4SP-(R13)

## 0007

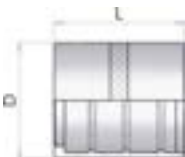

### Swaged Ferrule (no skive)

Product number	hose I.D.	I.D.	Dimension		skive	valid for
	in	mm	D	L	Length	-
0007-03	3/16	4.8	14	27	NO	R7-R6-1TE-2TE
0007-04	1/4	6.4	17	29	NO	R7-R6-1TE-2TE
0007-05	5/16	7.9	19	30	NO	R7-R6-1TE-2TE
0007-06	3/8	9.5	21	31	NO	R7-R6-1TE-2TE
0007-08	1/2	12.7	25.4	34	NO	R7-R6-1TE-2TE
0007-10	5/8	15.9	28.5	36	NO	R7-R6-1TE-2TE
0007-12	3/4	19	32	36	NO	R7-R6-1TE-2TE
0007-16	1	25.4	40	50	NO	R7-R6-1TE-2TE

## 0008

## Swaged Ferrule (no skive)

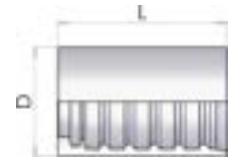

Product number	hose I.D.	I.D.	Dimension		skive	valid for
	in	mm	D	L	Length	-
0008-03	3/16	4.8	13	25	NO	R8
0008-04	1/4	6.4	17	29	NO	R8
0008-05	5/16	7.9	19	30	NO	R8
0008-06	3/8	9.5	21.5	31	NO	R8
0008-08	1/2	12.7	26	34	NO	R8
0008-10	5/8	15.9	29	40	NO	R8
0008-12	3/4	19	32	42	NO	R8
0008-16	1	25.4	40	50	NO	R8

## 0003

## Swaged Ferrule (no skive)



Product number	hose I.D.	I.D.	Dimension		skive	valid for
	in	mm	D	L	Length	-
0003-03	3/16	4.8	14	27	NO	R3-3TE-R5
0003-04	1/4	6.4	19	29	NO	R3-3TE-R5
0003-05	5/16	7.9	22	30	NO	R3-3TE-R5
0003-06	3/8	9.5	24	31	NO	R3-3TE-R5
0003-08	1/2	12.7	28.5	34	NO	R3-3TE-R5
0003-10	5/8	15.9	32	36	NO	R3-3TE-R5
0003-12	3/4	19	38	42	NO	R3-3TE-R5
0003-16	1	25.4	46	50	NO	R3-3TE
0003-20	1.1/4	31.8	52	57	NO	R3-3TE

## PTFE

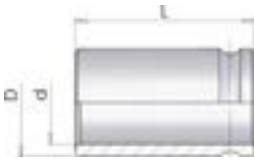

### Ferrule for PTFE hose

Product number	hose I.D.	Dimension			I.D.	skive	valid for
	in	D	mm	L	d-int	Length	-
PTFE-03	3/16	12.7	4.8	22	9.5	NO	PTFE type T1
PTFE-04	1/4	14.4	6.4	23.9	11.1	NO	PTFE type T1
PTFE-05	5/16	17.1	7.9	24.6	13	NO	PTFE type T1
PTFE-06	3/8	19	9.5	27.4	15	NO	PTFE type T1
PTFE-08	1/2	22.4	12.7	28.7	18.3	NO	PTFE type T1
PTFE-10	5/8	27	15.9	31.7	23.1	NO	PTFE type T1
PTFE-12	3/4	28.7	19	34.5	24.8	NO	PTFE type T1
PTFE-16	1	38.1	25.4	43.6	34.3	NO	PTFE type T1

For PTFE hose type T1 - (with standard fittings)

## PTFE-C

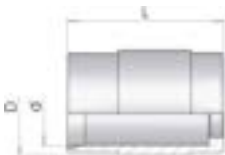

### Ferrule for PTFE hose

Product number	hose I.D.	Dimension			I.D.	skive	valid for
	in	D	mm	L	d-int	Length	-
PTFE-04-C	1/4	17.8	6.4	26.5	14.4	NO	PTFE type LTC
PTFE-06-C	3/8	20	9.5	30.5	16.8	NO	PTFE type LTC
PTFE-08-C	1/2	24	12.7	33.2	20.5	NO	PTFE type LTC
PTFE-10-C	5/8	29.2	15.9	34.8	25.4	NO	PTFE type LTC
PTFE-12-C	3/4	31.1	19	40.9	27.4	NO	PTFE type LTC
PTFE-16-C	1	38.5	25.4	47	34.7	NO	PTFE type LTC

For PTFE hose type LTC - (with standard fittings)

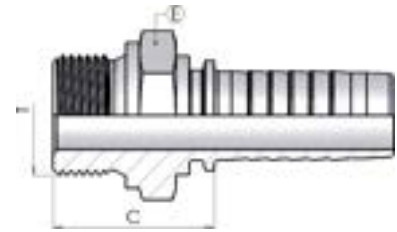

**0345****BSP Male - Flat Seat****(AGR-F)**

Product number	hose I.D.	Dimension				I.D.
	in	dash size	mm	T	E	Cut-off C
0345-04-04	1/4	04	6.4	1/4-19	19	27
0345-05-06	5/16	05	7.9	3/8-19	22	28
0345-06-06	3/8	06	9.5	3/8-19	22	29
0345-06-08	3/8	06	9.5	1/2-14	27	32
0345-08-08	1/2	08	12.7	1/2-14	27	33
0345-10-12	5/8	10	15.9	3/4-14	32	35
0345-12-12	3/4	12	19	3/4-14	32	36
0345-12-16	3/4	12	19	1-11	41	39
0345-16-16	1	16	25.4	1-11	41	40

# 0060

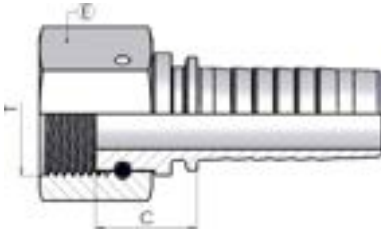

## BSP Female flat seat

**(DKR-F)**

Product number	hose I.D.		I.D.	Dimension		
	in	mm		dash size	T	E
0060-04-04	1/4	6.4	04	1/4-19	19	14
0060-04-06	1/4	6.4	04	3/8-19	22	15
0060-05-06	5/16	7.9	05	3/8-19	22	15
0060-05-08	5/16	7.9	05	1/2-14	27	17
0060-06-06	3/8	9.5	06	3/8-19	22	15
0060-06-08	3/8	9.5	06	1/2-14	27	16
0060-08-08	1/2	12.7	08	1/2-14	27	16
0060-08-12	1/2	12.7	08	3/4-14	32	23
0060-10-10	5/8	15.9	10	5/8-14	30	16
0060-10-12	5/8	15.9	10	3/4-14	32	20
0060-12-12	3/4	19	12	3/4-14	32	21
0060-12-16	3/4	19	12	1-11	38	23
0060-16-16	1	25.4	16	1-11	38	22

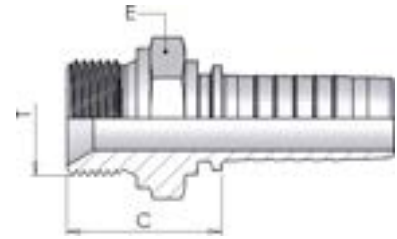
**BSP Male Parallel 60° cone****(AGR)**

Product number	hose I.D.	Dimension				I.D.
	in	dash size	mm	T	E	Cut-off C
0350-03-02	3/16	03	4.8	1/8-28	14	21
0350-03-04	3/16	03	4.8	1/4-19	19	26
0350-04-02	1/4	04	6.4	1/8-28	14	21
0350-04-04	1/4	04	6.4	1/4-19	19	27
0350-04-06	1/4	04	6.4	3/8-19	22	28
0350-04-08	1/4	04	6.4	1/2-14	27	35
0350-05-04	5/16	05	7.9	1/4-19	19	27
0350-05-06	5/16	05	7.9	3/8-19	22	28
0350-05-08	5/16	05	7.9	1/2-14	27	32
0350-06-04	3/8	06	9.5	1/4-19	19	27
0350-06-06	3/8	06	9.5	3/8-19	22	29
0350-06-08	3/8	06	9.5	1/2-14	27	32
0350-08-06	1/2	08	12.7	3/8-19	22	29
0350-08-08	1/2	08	12.7	1/2-14	27	33
0350-08-10	1/2	08	12.7	5/8-14	30	34
0350-08-12	1/2	08	12.7	3/4-14	32	35
0350-10-08	5/8	10	15.9	1/2-14	27	33
0350-10-10	5/8	10	15.9	5/8-14	30	35
0350-10-12	5/8	10	15.9	3/4-14	32	35
0350-12-08	3/4	12	19	1/2-14	27	33
0350-12-12	3/4	12	19	3/4-14	32	36
0350-12-16	3/4	12	19	1-11	41	39
0350-16-16	1	16	25.4	1-11	41	40
0350-16-20	1	16	25.4	1.1/4-11	50	44
0350-20-16	1.1/4	20	31.8	1-11	41	41
0350-20-20	1.1/4	20	31.8	1.1/4-11	50	45
0350-20-24	1.1/4	20	31.8	1.1/2-11	55	46
0350-24-24	1.1/2	24	38.1	1.1/2-11	55	46
0350-24-32	1.1/2	24	38.1	2-11	70	54
0350-32-24	2	32	50.8	1.1/2-11	65	50
0350-32-32	2	32	50.8	2-11	70	54

# 035G

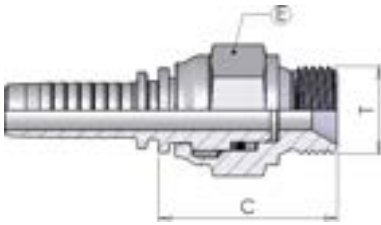

## BSP Male Parallel 60° Cone - Rotating

**(AGR-RO)**

Product number	hose I.D.	I.D.	Dimension			
	in	mm	dash size	T	E	Cut-off C
035G-04-04	1/4	6.4	04	1/4-19	19	37
035G-06-06	3/8	9.5	06	3/8-19	22	43
035G-08-08	1/2	12.7	08	1/2-14	27	47
035G-12-12	3/4	19	12	3/4-14	32	52

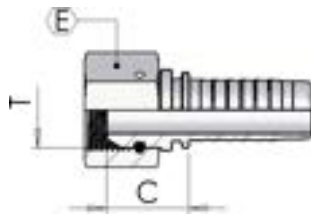
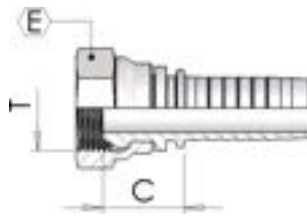
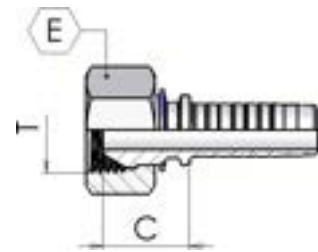
**0050****0051****0058****BSP Female 60° Cone****(DKR)**

Product number	hose I.D.		Dimension			
	in	mm	dash size	Thread T	hex E	Cut-off C
0051-03-02	3/16	4.8	03	1/8-28	14	15
0058-03-04	3/16	4.8	03	1/4-19	19	17
0051-04-02	1/4	6.4	04	1/8-28	14	15
0058-04-04	1/4	6.4	04	1/4-19	19	21
0058-04-06	1/4	6.4	04	3/8-19	22	21
0051-05-04	5/16	9.5	05	1/4-19	19	19
0058-05-06	5/16	7.9	05	3/8-19	22	21
0058-05-08	5/16	7.9	05	1/2-14	27	22
0051-06-04	3/8	9.5	06	1/4-19	19	17
0058-06-06	3/8	9.5	06	3/8-19	22	21
0058-06-08	3/8	9.5	06	1/2-14	27	23
0051-08-06	1/2	12.7	08	3/8-19	22	20
0058-08-08	1/2	12.7	08	1/2-14	27	23
0051-08-10	1/2	12.7	08	5/8-14	30	20
0051-08-12	1/2	12.7	08	3/4-14	32	27
0051-10-08	5/8	15.9	10	1/2-14	27	23
0051-10-10	5/8	15.9	10	5/8-14	30	20
0051-10-12	5/8	15.9	10	3/4-14	32	25
0051-12-08	3/4	19	12	1/2-14	27	24
0051-12-12	3/4	19	12	3/4-14	32	25
0051-12-16	3/4	19	12	1-11	38	26
0051-16-12	1	25.4	16	3/4-14	32	27
0051-16-16	1	25.4	16	1-11	38	27
0050-16-20	1	25.4	16	1.1/4-11	50	30
0050-20-20	1.1/4	31.8	20	1.1/4-11	50	32
0050-20-24	1.1/4	31.8	20	1.1/2-11	55	34
0050-24-24	1.1/2	38.1	24	1.1/2-11	55	34
0050-24-32	1.1/2	38.1	24	2-11	70	34
0050-32-32	2	50.8	32	2-11	70	31
0050-40-40	2.1/2	63.5	40	2.1/2-11	85	41
0050-48-48	3	76.2	25.8	3-11	100	45

# 0051D

## BSP Female 60° Cone - Double Hexagon

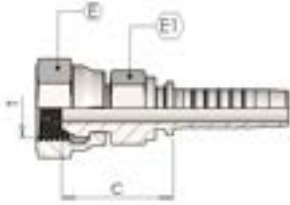

Product number	hose I.D.		Dimension				
	in	mm	dash size	T	E	E1	C
0051D04-04	1/4	6,4	04	1/4-19	19	14	22
0051D06-06	3/8	9,5	06	3/8-19	22	17	28
0051D08-08	1/2	12,7	08	1/2-14	27	22	30
0051D12-12	3/4	19	12	3/4-14	32	27	35

## 0150

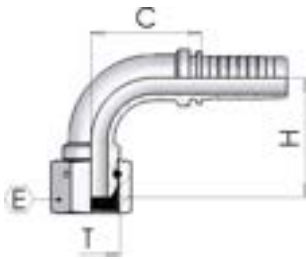

## 0151

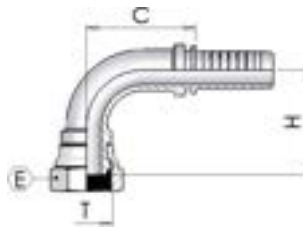

## 0158

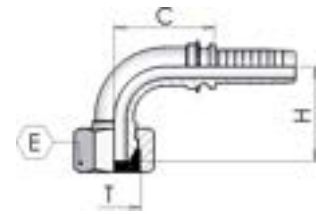

### BSP 90° Swept elbow 60° cone

Product number	hose I.D.		Dimension				
	in	mm	dash size	T	E	H	Cut-off C
0151-03-02	3/16	4.8	03	1/8-28	14	23	23
0151-03-04	3/16	4.8	03	1/4-19	19	25	25
0151-04-02	1/4	6.4	04	1/8-28	14	25	25
0158-04-04	1/4	6.4	04	1/4-19	19	21	27
0158-04-06	1/4	6.4	04	3/8-19	22	24	27
0151-05-04	5/16	7.9	05	1/4-19	19	31	31
0158-05-06	5/16	7.9	05	3/8-19	22	29	31
0151-06-04	3/8	9.5	06	1/4-19	19	33	31
0158-06-06	3/8	9.5	06	3/8-19	22	29	33
0158-06-08	3/8	9.5	06	1/2-14	27	31	36
0151-08-06	1/2	12.7	08	3/8-19	22	42	39
0158-08-08	1/2	12.7	08	1/2-14	27	37.5	38.5
0151-08-10	1/2	12.7	08	5/8-14	30	41	40
0151-08-12	1/2	12.7	08	3/4-14	32	46	41
0151-10-10	5/8	15.9	10	5/8-14	30	43	43
0151-10-12	5/8	15.9	10	3/4-14	32	50	45
0151-12-12	3/4	19	12	3/4-14	32	57	56
0151-12-16	3/4	19	12	1-11	38	56	56
0151-16-16	1	25.4	16	1-11	38	67	70
0150-20-20	1.1/4	31.8	20	1.1/4-11	50	84	83
0150-24-24	1.1/2	38.1	24	1.1/2-11	55	95	103
0150-32-32	2	50.8	32	2-11	70	124	133

## 0250

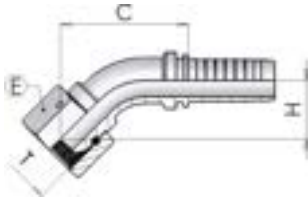

## 0251

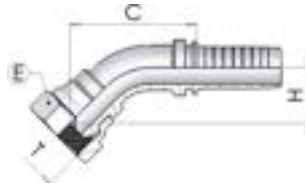

## 0258

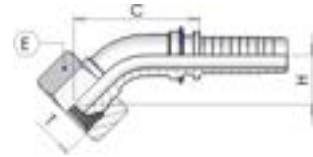

### BSP 45° Swept Elbow 60° Cone

### (DKR-45°)

Product number	hose I.D.		Dimension				
	in	mm	dash size	T	E	H	C
0251-03-02	3/16	4.8	03	1/8-28	14	15	33
0251-04-02	1/4	6.4	04	1/8-28	14	14	40
0258-04-04	1/4	6.4	04	1/4-19	19	14	39
0258-04-06	1/4	6.4	04	3/8-19	22	16	41
0251-05-04	5/16	7.9	05	1/4-19	19	16	47
0251-06-04	3/8	9.5	06	1/4-19	19	19	50
0258-06-06	3/8	9.5	06	3/8-19	22	17	47
0258-06-08	3/8	9.5	06	1/2-14	27	16	52
0251-08-06	1/2	12.7	08	3/8-19	22	22	63
0258-08-08	1/2	12.7	08	1/2-14	27	19	61
0251-08-10	1/2	12.7	08	5/8-14	30	21	64
0251-08-12	1/2	12.7	08	3/4-14	32	26	67
0251-10-08	5/8	15.9	10	1/2-14	27	24	68
0251-10-10	5/8	15.9	10	5/8-14	30	23	68
0251-10-12	5/8	15.9	10	3/4-14	32	27	72
0251-12-12	3/4	19	12	3/4-14	32	28	88
0251-12-16	3/4	19	12	1-11	38	32	88
0251-16-16	1	25.4	16	1-11	38	30	88
0250-20-20	1.1/4	31.8	20	1.1/4-11	50	40	107
0250-24-24	1.1/2	38.1	24	1.1/2-11	55	51	117
0250-32-32	2	50.8	32	2-11	70	59	146

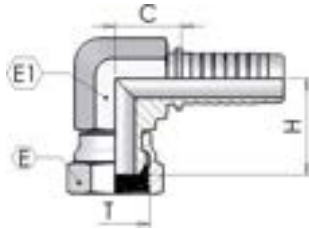
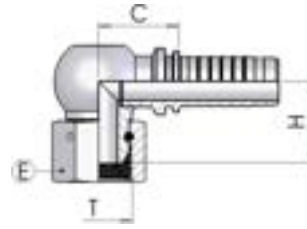

**2321****2300****BSP 90° Compact Elbow 60° Cone**

Product number	hose I.D.		Dimension					
	in	mm	dash size	T	E	EI	H	C
2321-03-02	3/16	4.8	03	1/8-28	14	12	18	17
2321-03-04	3/16	4.8	03	1/4-19	19	14	20	17
2321-04-04	1/4	6.4	04	1/4-19	19	15	20	19
2321-04-06	1/4	6.4	04	3/8-19	22	17	29	24
2321-05-06	5/16	7.9	05	3/8-19	22	17	23	24
2321-06-06	3/8	9.5	06	3/8-19	22	17	23	23
2321-06-08	3/8	9.5	06	1/2-14	27	19	26	28
2321-08-08	1/2	12.7	08	1/2-14	27	22	27	26
2321-10-10	5/8	15.9	10	5/8-14	30	24	28	29
2321-12-12	3/4	19	12	3/4-14	32	27	32	32
2321-16-16	1	25.4	16	1-11	38	32	36	38
2300-20-20	1.1/4	31.8	20	1.1/4-11	50	-	46	47

## 0041

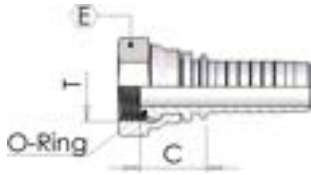

## 0048

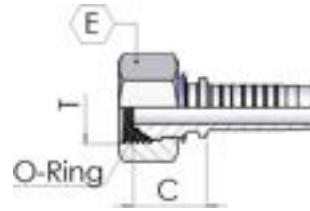

### BSP O'Ring Female 60° Cone

#### (DKR-OR)

Product number	hose I.D.		Dimension			
	in	mm	dash size	Thread T	hex E	Cut-off C
0048-04-04	1/4	6.4	04	1/4-19	19	22
0048-04-06	1/4	6.4	04	3/8-19	22	20
0048-06-06	3/8	9.5	06	3/8-19	22	20
0048-06-08	3/8	9.5	06	1/2-14	27	23
0048-08-08	1/2	12.7	08	1/2-14	27	23
0041-10-10	5/8	15.9	10	5/8-14	30	21
0041-12-12	3/4	19	12	3/4-14	32	26
0041-16-16	1	25.4	16	1-11	38	28

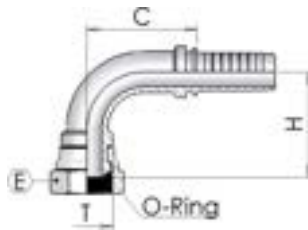
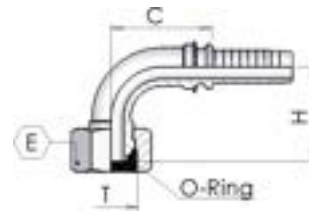
**0141****0148****BSP O'Ring 90° Swept elbow 60° cone****(DKR-OR 90°)**

Product number	hose I.D.		Dimension				
	in	mm	dash size	T	E	H	C
0148-04-04	1/4	6.4	04	1/4-19	19	22	27
0148-04-06	1/4	6.4	04	3/8-19	22	23	27
0148-06-06	3/8	9.5	06	3/8-19	22	23	27
0148-06-08	3/8	9.5	06	1/2-14	27	30	33
0148-08-08	1/2	12.7	08	1/2-14	27	35	42
0141-10-10	5/8	15.9	10	5/8-14	30	54	37
0141-12-12	3/4	19	12	3/4-14	32	58	56
0141-16-16	1	25.4	16	1-11	38	67	70

## 0241

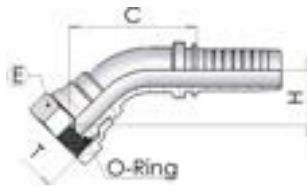

## 0248

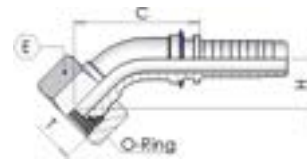

### BSP O'Ring 45° Swept Elbow 60° Cone

### (DKR-OR 45°)

Product number	hose I.D.		Dimension				
	in	mm	dash size	T	E	H	C
0248-04-04	1/4	6.4	04	1/4-19	19	15	41
0248-06-06	3/8	9.5	06	3/8-19	22	15	47
0248-08-08	1/2	12.7	08	1/2-14	27	19	61
0241-12-12	3/4	19	12	3/4-14	32	28	88
0241-16-16	1	25.4	16	1-11	38	32	114

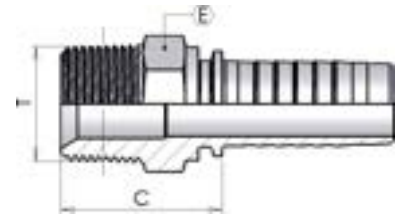
**0360****BSP Taper Male 60° cone****(AGR-K)**

Product number	hose I.D.		I.D.	Dimension		
	in	mm		dash size	T	E
0360-03-02	3/16	4.8	03	1/8-28	12	21
0360-03-04	3/16	4.8	03	1/4-19	15	27
0360-04-02	1/4	6.4	04	1/8-28	12	22
0360-04-04	1/4	6.4	04	1/4-19	15	28
0360-04-06	1/4	6.4	04	3/8-19	19	28
0360-05-04	5/16	7.9	05	1/4-19	15	28
0360-05-06	5/16	7.9	05	3/8-19	19	28
0360-06-04	3/8	9.5	06	1/4-19	17	28
0360-06-06	3/8	9.5	06	3/8-19	19	28
0360-06-08	3/8	9.5	06	1/2-14	22	33
0360-08-06	1/2	12.7	08	3/8-19	19	29
0360-08-08	1/2	12.7	08	1/2-14	22	34
0360-08-12	1/2	12.7	08	3/4-14	27	36
0360-12-12	3/4	19	12	3/4-14	27	37
0360-12-16	3/4	19	12	1-11	36	43
0360-16-16	1	25.4	16	1-11	36	44
0360-20-20	1.1/4	31.8	20	1.1/4-11	46	47
0360-24-24	1.1/2	38.1	24	1.1/2-11	50	49
0360-32-32	2	50.8	32	2-11	65	55

# 0370

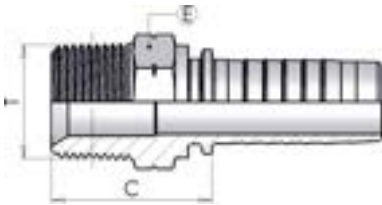

**NPTF Male 60° cone**

**(AGN)**

Product number	hose I.D.		Dimension			
	in	mm	dash size	Cut-off C	T	E
0370-03-02	3/16	4.8	03	22	1/8-27	12
0370-03-04	3/16	4.8	03	27	1/4-18	15
0370-04-02	1/4	6.4	04	22	1/8-27	12
0370-04-04	1/4	6.4	04	28	1/4-18	15
0370-04-06	1/4	6.4	04	28	3/8-18	19
0370-05-04	5/16	7.9	05	28	1/4-18	15
0370-05-06	5/16	7.9	05	28	3/8-18	19
0370-06-04	3/8	9.5	06	28	1/4-18	17
0370-06-06	3/8	9.5	06	28	3/8-18	19
0370-06-08	3/8	9.5	06	34	1/2-14	22
0370-08-06	1/2	12.7	08	29	3/8-18	19
0370-08-08	1/2	12.7	08	35	1/2-14	22
0370-08-12	1/2	12.7	08	36	3/4-14	27
0370-10-08	5/8	15.9	10	35	1/2-14	24
0370-10-12	5/8	15.9	10	36	3/4-14	27
0370-12-08	3/4	19	12	36	1/2-14	24
0370-12-12	3/4	19	12	37	3/4-14	27
0370-12-16	3/4	19	12	43	1-11.1/2	36
0370-16-16	1	25.4	16	44	1-11.1/2	36
0370-20-20	1.1/4	31.8	20	47	1.1/4-11.1/2	46
0370-24-24	1.1/2	38.1	24	49	1.1/2-11.1/2	50
0370-32-32	2	50.8	32	55	2-11.1/2	65
0370-40-40	2.1/2	63.5	40	55	2.1/2-8	80
0370-48-48	3	76.2	48	58	3-8	90

## 037G

### NPTF Male Parallel 60° Cone - Rotating (AGN-RO)

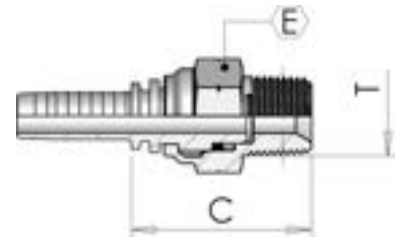

Product number	hose I.D.	I.D.	Dimension			
	in	mm	dash size	T	E	Cut-off C
037G-04-04	1/4	6.4	04	1/4-18	19	39
037G-06-06	3/8	9.5	06	3/8-18	22	43
037G-08-08	1/2	12.7	08	1/2-14	27	49
037G-12-12	3/4	19	12	3/4-14	32	52

## N051

### NPSM Female 60° Cone Rolled Nut (DKN)

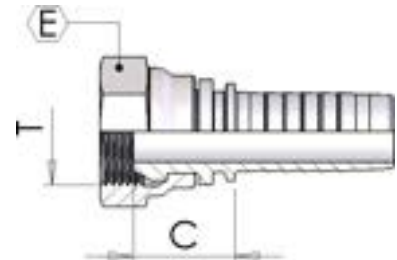

Product number	hose I.D.	I.D.	Dimension			
	in	mm	dash size	T	E	Cut-off C
N051-03-04	3/16	4.8	03	1/4-18	19	17
N051-04-04	1/4	6.4	04	1/4-18	19	17
N051-06-06	3/8	9.5	06	3/8-18	22	19
N051-08-08	1/2	12.7	08	1/2-14	27	23
N051-12-12	3/4	19.1	12	3/4-14	32	25
N051-16-16	1	25.4	16	1-11	38	27

# 0850

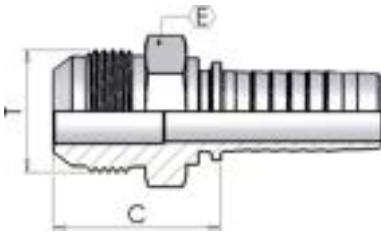

**JIC Male 74° cone**

**(AGJ)**

Product number	hose I.D.		I.D.	Dimension		
	in	mm		dash size	T	E
0850-03-04	3/16	4.8	03	7/16-20	12	26
0850-04-04	1/4	6.4	04	7/16-20	12	27
0850-04-05	1/4	6.4	04	1/2-20	14	27
0850-04-06	1/4	6.4	04	9/16-18	15	27
0850-05-05	5/16	7.9	05	1/2-20	14	27
0850-05-06	5/16	7.9	05	9/16-18	15	27
0850-05-08	5/16	7.9	05	3/4-16	19	30
0850-06-06	3/8	9.5	06	9/16-18	15	27
0850-06-07	3/8	9.5	06	5/8-18	17	30
0850-06-08	3/8	9.5	06	3/4-16	19	30
0850-06-10	3/8	9.5	06	7/8-14	24	34
0850-08-08	1/2	12.7	08	3/4-16	19	31
0850-08-10	1/2	12.7	08	7/8-14	24	35
0850-08-12	1/2	12.7	08	1.1/16-12	27	37
0850-10-10	5/8	15.9	10	7/8-14	24	35
0850-10-12	5/8	15.9	10	1.1/16-12	27	37
0850-12-10	3/4	19	12	7/8-14	24	36
0850-12-12	3/4	19	12	1.1/16-12	27	38
0850-12-14	3/4	19	12	1.3/16-12	32	41
0850-12-16	3/4	19	12	1.5/16-12	34	42
0850-16-12	1	25.4	16	1.1/16-12	27	39
0850-16-16	1	25.4	16	1.5/16-12	34	43
0850-16-20	1	25.4	16	1.5/8-12	42	46
0850-20-20	1.1/4	31.8	20	1.5/8-12	42	47
0850-20-24	1.1/4	31.8	20	1.7/8-12	50	52
0850-24-24	1.1/2	38.1	24	1.7/8-12	50	52
0850-32-32	2	50.8	32	2.1/2-12	65	62

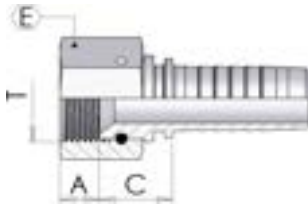
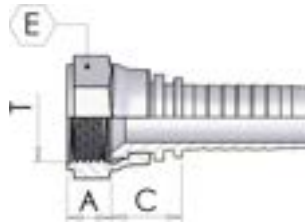
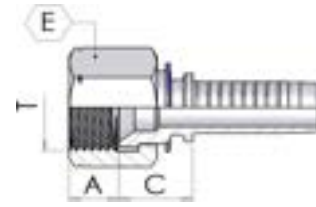

**0900****0901****0902****JIC Female 74°****(DKJ)**

Product number	hose I.D.		Dimension				
	in	mm	dash size	T	E	Cut-off C	A
0901-03-04	3/16	4.8	03	7/16-20	15	14	8.5
0901-03-05	3/16	4.8	03	1/2-20	17	14	9.5
0901-04-04	1/4	6.4	04	7/16-20	15	14	8.5
0902-04-05	1/4	6.4	04	1/2-20	17	17	9.5
0902-04-06	1/4	6.4	04	9/16-18	19	17	9
0901-04-07	1/4	6.4	04	5/8-18	22	17	11
0901-05-05	5/16	7.9	05	1/2-20	17	17	9.5
0901-05-07	5/16	7.9	05	5/8-18	22	17	11
0901-06-04	3/8	9.5	06	7/16-20	15	15	9
0901-06-05	3/8	9.5	06	1/2-20	17	15	9.5
0901-06-06	3/8	9.5	06	9/16-18	19	16	9
0901-06-07	3/8	9.5	06	5/8-18	22	16	11
0902-06-08	3/8	9.5	06	3/4-16	22	18	10.5
0901-08-08	1/2	12.7	08	3/4-16	24	18	10.5
0902-08-10	1/2	12.7	08	7/8-14	27	20	13
0901-10-10	5/8	15.9	10	7/8-14	27	20	13
0902-10-12	5/8	15.9	10	1.1/16-12	32	20	13.5
0901-12-10	3/4	19	12	7/8-14	27	20	13
0902-12-12	3/4	19	12	1.1/16-12	32	22	13.5
0901-12-14	3/4	19	12	1.3/16-12	36	23	14
0901-12-16	3/4	19	12	1.5/16-12	38	23	15.5
0901-16-12	1	25.4	12	1.1/16-12	32	23	13.5
0901-16-16	1	25.4	16	1.5/16-12	38	24	15.5
0900-16-20	1	25.4	16	1.5/8-12	50	27	16.5
0900-20-20	1.1/4	31.8	20	1.5/8-12	50	28	16.5
0900-20-24	1.1/4	31.8	20	1.7/8-12	55	31	19
0900-24-24	1.1/2	38.1	24	1.7/8-12	55	31	19
0900-32-32	2	50.8	32	2.1/2-12	70	31	20

# 0901D

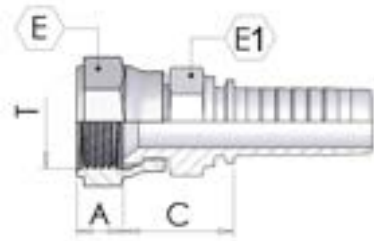

## JIC Female 74° Cone- Double Hexagon

**(DKJ)**

Product number	hose I.D.		Dimension					
	in	mm	dash size	T	E	E1	C	A
0901D04-04	1/4	6.4	04	7/16-20	15	12	20	8.5
0901D04-05	1/4	6.4	04	1/2-20	17	14	20	9.5
0901D04-06	1/4	6.4	04	9/16-18	19	14	22	9
0901D06-06	3/8	9.5	06	9/16-18	19	17	24	9
0901D06-08	3/8	9.5	06	3/4-16	24	19	26	10.5
0901D08-08	1/2	12.7	08	3/4-16	24	22	26	10.5
0901D08-10	1/2	12.7	08	7/8-14	27	22	27	13
0901D10-10	5/8	15.9	10	7/8-14	27	22	26	13
0901D10-12	5/8	15.9	10	1.1/16-12	32	27	27	13.5
0901D12-12	3/4	19	12	1.1/16-12	32	27	32	13.5
0901D16-16	1	25.4	16	1.5/16-12	38	36	33	15.5

### 0950

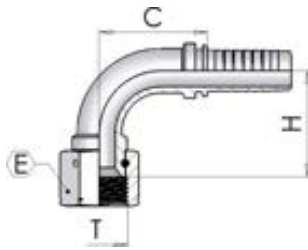

### 0951



### 0952

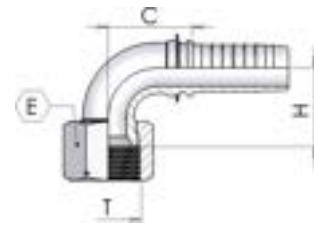

## JIC 90° Swept Elbow 74° cone

Product number	hose I.D.		Dimension				
	in	mm	dash size	T	E	H	C
0951-03-04	3/16	4.8	03	7/16-20	15	22	22
0951-03-05	3/16	4.8	03	1/2-20	17	22	22
0951-04-04	1/4	6.4	04	7/16-20	15	22	22
0952-04-05	1/4	6.4	04	1/2-20	17	21	27
0952-04-06	1/4	6.4	04	9/16-18	19	21	26
0951-05-05	5/16	7.9	05	1/2-20	17	30	29
0951-05-06	5/16	7.9	05	9/16-18	19	31	29
0951-06-05	3/8	9.5	06	1/2-20	17	33	30
0951-06-06	3/8	9.5	06	9/16-18	19	32	31
0951-06-07	3/8	9.5	06	5/8-18	22	32	33
0952-06-08	3/8	9.5	06	3/4-16	22	34	41
0951-06-10	3/8	9.5	06	7/8-14	27	36	33
0951-08-08	1/2	12.7	08	3/4-16	24	41	41
0952-08-10	1/2	12.7	08	7/8-14	27	34	41
0951-08-12	1/2	12.7	08	1.1/16-12	32	43	42
0951-10-10	5/8	15.9	10	7/8-14	27	44	43
0951-12-10	3/4	19	12	7/8-14	27	53	56
0952-10-12	5/8	15.9	10	1.1/16-12	32	37	47
0952-12-12	3/4	19	12	1.1/16-12	32	45	58
0951-12-14	3/4	19	12	1.3/16-12	36	53	56
0951-12-16	3/4	19	12	1.5/16-12	38	55	60
0951-16-12	1	25.4	16	1.1/16-12	38	55	60
0951-16-16	1	25.4	16	1.5/16-12	32	63	70
0950-20-20	1.1/4	31.8	20	1.5/8-12	50	85	82
0950-24-24	1.1/2	38.1	24	1.7/8-12	55	97	104
0950-32-32	2	50.8	32	2.1/2-12	70	134	124

## 1000

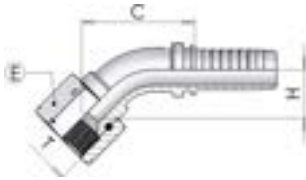

## 1001

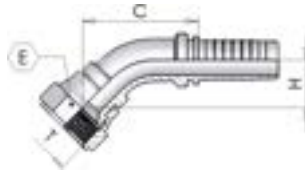

## 1002

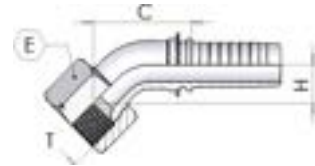

### JIC 45° Swept Elbow 74°

### (DKJ-45°)

Product number	hose I.D.		Dimension				
	in	mm	dash size	T	E	H	C
1001-03-04	3/16	4.8	03	7/16-20	15	15	33
1001-04-04	1/4	6.4	04	7/16-20	15	13	38
1002-04-05	1/4	6.4	04	1/2-20	17	11	38
1002-04-06	1/4	6.4	04	9/16-18	19	11	38
1001-05-05	5/16	7.9	05	1/2-20	17	17	46
1001-05-06	5/16	7.9	05	9/16-18	19	18	47
1001-06-05	3/8	9.5	06	1/2-20	17	18	49
1001-06-06	3/8	9.5	06	9/16-18	19	17	51
1002-06-08	3/8	9.5	06	3/4-16	22	13	48
1001-06-10	3/8	9.5	06	7/8-14	27	21	54
1001-08-08	1/2	12.7	08	3/4-16	24	22	62
1002-08-10	1/2	12.7	08	7/8-14	27	16	58
1001-08-12	1/2	12.7	08	1.1/16-12	32	25	68
1001-10-10	5/8	15.9	10	7/8-14	27	24	68
1002-10-12	5/8	15.9	10	1.1/16-12	32	18	66
1002-12-12	3/4	19	12	1.1/16-12	32	21	81
1001-12-14	3/4	19	12	1.3/16-12	36	29	84
1001-12-16	3/4	19	12	1.5/16-12	38	28	88
1001-16-16	1	25.4	16	1.5/16-12	38	29	83
1000-20-20	1.1/4	31.8	20	1.5/8-12	50	42	108
1000-24-24	1.1/2	38.1	24	1.7/8-12	55	49	156
1000-32-32	2	50.8	32	2.1/2-12	70	65	142

## 095S

### JIC 90° Swept Elbow 74° cone - ISO SHORT

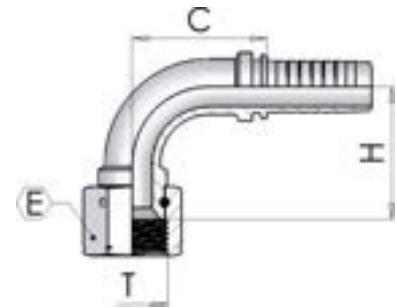

Product number	hose I.D.		Dimension				
	in	mm	dash size	T	E	H	C
095S-04-04	1/4	6.4	04	7/16-20	15	22	25
095S-06-06	3/8	9.5	06	9/16-18	19	23	31
095S-08-08	1/2	12.7	08	3/4-16	24	29	41
095S-10-10	5/8	15.9	10	7/8-14	27	32	43
095S-12-12	3/4	19	12	1.1/16-12	32	48	56
095S-16-16	1	25.4	16	1.5/16-12	41	57	70

## 2971

### JIC 90° Compact Elbow 74° cone - Crimped Nut

(DKJ-90°K)

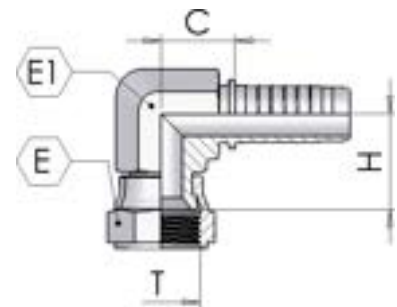

Product number	hose I.D.		Dimension					
	in	mm	dash size	T	E	E1	H	C
2971-04-04	1/4	6.4	04	7/16-20	15	15	17	19
2971-04-05	1/4	6.4	04	1/2-20	17	15	18	19
2971-04-06	1/4	6.4	04	9/16-18	19	15	19	19
2971-05-06	5/16	7.9	05	9/16-18	19	17	20	20
2971-06-06	3/8	9.5	06	9/16-18	19	17	20	23
2971-06-08	3/8	9.5	06	3/4-16	24	19	22	24
2971-08-08	1/2	12.7	08	3/4-16	24	22	22.5	26.5
2971-08-10	1/2	12.7	08	7/8-14	27	22	23.5	26.5
2971-12-12	3/4	19.1	12	1.1/16-12	32	27	28.5	31.5
2971-16-16	1	25.4	16	1.5/16-12	38	32	33.5	37.5

# 0385

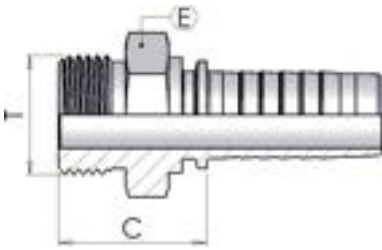

## SAE Male O'R Flat Seat

**(SAE-OR)**

Product number	hose I.D.	I.D.	Dimension			
	in	mm	dash size	T	E	Cut-off C
0385-04-04	1/4	6.4	04	7/16-20	14	24
0385-04-06	1/4	6.4	04	9/16-18	17	24
0385-05-06	5/16	7.9	05	9/16-18	17	24
0385-06-06	3/8	9.5	06	9/16-18	17	25
0385-06-08	3/8	9.5	06	3/4-16	22	28
0385-08-08	1/2	12.7	08	3/4-16	22	28
0385-08-10	1/2	12.7	08	7/8-14	27	30
0385-08-12	1/2	12.7	08	1.1/16-12	32	32
0385-10-10	5/8	15.9	10	7/8-14	27	30
0385-10-12	5/8	15.9	10	1.1/16-12	32	32
0385-12-12	3/4	19	12	1.1/16-12	32	33

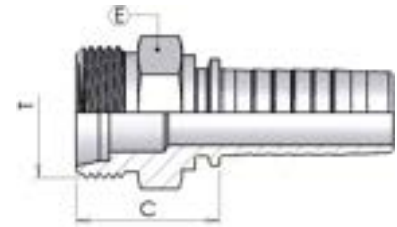
**Metric Male 24° Seat Light****(CEL)**

Product number	hose I.D.		Dimension				I.D. Cut-off C
	in	dash size	mm	T	erm.	E	
0500-03-12	3/16	03	4.8	M12-1.5	6	14	22
0500-03-14	3/16	03	4.8	M14-1.5	8	14	22
0500-04-12	1/4	04	6.4	M12-1.5	6	14	23
0500-04-14	1/4	04	6.4	M14-1.5	8	14	22
0500-04-16	1/4	04	6.4	M16-1.5	10	17	23
0500-04-18	1/4	04	6.4	M18-1.5	12	19	24
0500-05-14	5/16	05	7.9	M14-1.5	8	14	22
0500-05-16	5/16	05	7.9	M16-1.5	10	17	23
0500-05-18	5/16	05	7.9	M18-1.5	12	19	24
0500-05-22	5/16	05	7.9	M22-1.5	15	22	25
0500-06-16	3/8	06	9.5	M16-1.5	10	17	23
0500-06-18	3/8	06	9.5	M18-1.5	12	19	24
0500-06-22	3/8	06	9.5	M22-1.5	15	22	25
0500-08-18	1/2	08	12.7	M18-1.5	12	19	25
0500-08-22	1/2	08	12.7	M22-1.5	15	22	26
0500-08-26	1/2	08	12.7	M26-1.5	18	27	27
0500-10-22	5/8	10	15.9	M22-1.5	15	22	26
0500-10-26	5/8	10	15.9	M26-1.5	18	27	27
0500-10-30	5/8	10	15.9	M30-2	22	30	32
0500-12-26	3/4	12	19	M26-1.5	18	27	28
0500-12-30	3/4	12	19	M30-2	22	30	33
0500-16-36	1	16	25.4	M36-2	28	36	32
0500-20-45	1.1/4	20	31.8	M45-2	35	46	36
0500-24-52	1.1/2	24	38.1	M52-2	42	55	38

# 0085

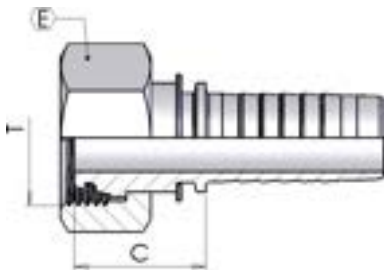

## Metric Female 24° Seat Light

(DKOL)

Product number	hose I.D.		Dimension				I.D.
	in	dash size	mm	T	erm.	€	Cut-off C
0085-03-12	3/16	03	4.8	M12-1.5	6	14	23
0085-03-14	3/16	03	4.8	M14-1.5	8	17	24
0085-04-12*	1/4	04	6.4	M12-1.5	6	14	25
0085-04-14	1/4	04	6.4	M14-1.5	8	17	24
0085-04-16	1/4	04	6.4	M16-1.5	10	19	24
0085-04-18	1/4	04	6.4	M18-1.5	12	22	25
0085-05-14*	5/16	05	7.9	M14-1.5	8	17	26
0085-05-16	5/16	05	7.9	M16-1.5	10	19	24
0085-05-18	5/16	05	7.9	M18-1.5	12	22	25
0085-06-16*	3/8	06	9.5	M16-1.5	10	19	25
0085-06-18	3/8	06	9.5	M18-1.5	12	22	25
0085-06-22	3/8	06	9.5	M22-1.5	15	27	29
0085-08-18*	1/2	08	12.7	M18-1.5	12	22	28
0085-08-22	1/2	08	12.7	M22-1.5	15	27	29
0085-08-26	1/2	08	12.7	M26-1.5	18	32	29
0085-10-22*	5/8	10	15.9	M22-1.5	15	27	31
0085-10-26	5/8	10	15.9	M26-1.5	18	32	29
0085-10-30	5/8	10	15.9	M30-2	22	36	29
0085-12-26*	3/4	12	19	M26-1.5	18	32	35
0085-12-30	3/4	12	19	M30-2	22	36	29
0085-12-36	3/4	12	19	M36-2	28	41	28
0085-16-36	1	16	25.4	M36-2	28	41	30
0085-20-45	1.1/4	20	31.8	M45-2	35	50	40
0085-20-52	1.1/4	20	31.8	M52-2	42	60	43
0085-24-52	1.1/2	24	38.1	M52-2	42	60	41

\*Rolled Nut



0185

## 90° Metric Swept Elbow 24° Seat Light

### (DKOL-90°)

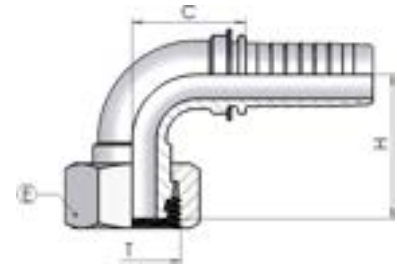

Product number	hose I.D.		Dimension					
	in	mm	dash size	T	erm.	E	H	Cut-off C
0185-03-12	3/16	4.8	03	M12-1.5	6	14	23	22
0185-03-14	3/16	4.8	03	M14-1.5	8	17	24	23
0185-04-12*	1/4	6.4	04	M12-1.5	6	14	34	26
0185-04-14	1/4	6.4	04	M14-1.5	8	17	26	26
0185-04-16	1/4	6.4	04	M16-1.5	10	19	27	25
0185-04-18	1/4	6.4	04	M18-1.5	12	22	30	27
0185-05-14*	5/16	7.9	05	M14-1.5	8	19	38	30
0185-05-16	5/16	7.9	05	M16-1.5	10	19	31	31
0185-05-18	5/16	7.9	05	M18-1.5	12	22	32	31
0185-06-16*	3/8	9.5	06	M16-1.5	10	19	39	32
0185-06-18	3/8	9.5	06	M18-1.5	12	22	35	32
0185-06-22	3/8	9.5	06	M22-1.5	15	27	35	32
0185-08-18*	1/2	12.7	08	M18-1.5	12	24	48	40
0185-08-22	1/2	12.7	08	M22-1.5	15	27	38	41
0185-08-26	1/2	12.7	08	M26-1.5	18	32	39	41
0185-10-22*	5/8	15.9	10	M22-1.5	15	27	55	42
0185-10-26	5/8	15.9	10	M26-1.5	18	32	44	44
0185-12-30	3/4	19	12	M30-2	22	36	52	58
0185-16-36	1	25.4	16	M36-2	28	41	62	72
0185-20-45	1.1/4	31.8	20	M45-2	35	50	81	84
0185-24-52	1.1/2	38.1	24	M52-2	42	60	93	102

\*Rolled Nut

# 0285

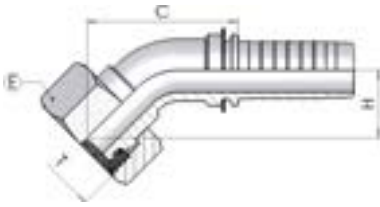

## 45° Metric Swept Elbow 24° Seat Light

**(DKOL-45°)**

Product number	hose I.D.		Dimension					
	in	mm	dash size	T	erm.	E	H	Cut-off C
0285-03-12	3/16	4.8	03	M12-1.5	6	14	14	36
0285-04-12*	1/4	6.4	04	M12-1.5	6	14	21	46
0285-04-14	1/4	6.4	04	M14-1.5	8	17	14	42
0285-04-16	1/4	6.4	04	M16-1.5	10	19	15	42
0285-04-18	1/4	6.4	04	M18-1.5	12	22	16	43
0285-05-16	5/16	7.9	05	M16-1.5	10	19	17	48
0285-05-18	5/16	7.9	05	M18-1.5	12	22	18	48
0285-06-16*	3/8	9.5	06	M16-1.5	10	19	22	55
0285-06-18	3/8	9.5	06	M18-1.5	12	22	19	52
0285-06-22	3/8	9.5	06	M22-1.5	15	27	19	51
0285-08-22	1/2	12.7	08	M22-1.5	15	27	21	63
0285-08-26	1/2	12.7	08	M26-1.5	18	32	22	63
0285-10-22*	5/8	15.9	10	M22-1.5	15	27	32	75
0285-10-26	5/8	15.9	10	M26-1.5	18	32	23	68
0285-12-30	3/4	19	12	M30-2	22	36	25	86
0285-16-36	1	25.4	16	M36-2	28	41	29	81
0285-20-45	1.1/4	31.8	20	M45-2	35	50	32	106
0285-24-52	1.1/2	38.1	24	M52-2	42	60	43	119

\*Rolled Nut

0450

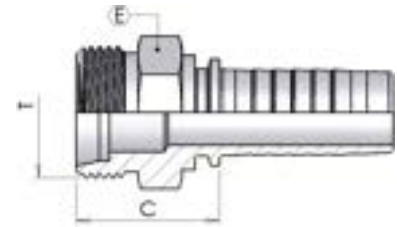
**Metric Male 24° Seat Heavy****(CES)**

Product number	hose I.D.		Dimension				
	in	mm	dash size	T	erm.	E	Cut-off C
0450-03-16	3/16	4.8	03	M16-1.5	8	17	26
0450-04-14	1/4	6.4	04	M14-1.5	6	14	25
0450-04-16	1/4	6.4	04	M16-1.5	8	17	27
0450-04-18	1/4	6.4	04	M18-1.5	10	19	27
0450-04-20	1/4	6.4	04	M20-1.5	12	22	27
0450-05-18	5/16	7.9	05	M18-1.5	10	19	27
0450-05-20	5/16	7.9	05	M20-1.5	12	22	29
0450-06-18	3/8	9.5	06	M18-1.5	10	19	27
0450-06-20	3/8	9.5	06	M20-1.5	12	22	29
0450-06-22	3/8	9.5	06	M22-1.5	14	22	31
0450-06-24	3/8	9.5	06	M24-1.5	16	24	31
0450-08-20	1/2	12.7	08	M20-1.5	12	22	29
0450-08-22	1/2	12.7	08	M22-1.5	14	22	31
0450-08-24	1/2	12.7	08	M24-1.5	16	24	32
0450-08-30	1/2	12.7	08	M30-2	20	30	33
0450-10-30	5/8	15.9	10	M30-2	20	30	34
0450-12-30	3/4	19	12	M30-2	20	30	35
0450-12-36	3/4	19	12	M36-2	25	36	38
0450-16-36	1	25.4	16	M36-2	25	36	39
0450-16-42	1	25.4	16	M42-2	30	46	42
0450-20-42	1.1/4	31.8	20	M42-2	30	46	43
0450-20-52	1.1/4	31.8	20	M52-2	38	55	45
0450-24-52	1.1/2	38.1	24	M52-2	38	55	45

# 0084

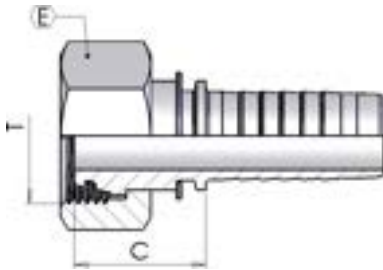

## Metric Female 24° Seat Heavy

**(DKOS)**

Product number	hose I.D.		dash size	Dimension			
	in	mm		T	erm.	€	Cut-off C
0084-03-14	3/16	4.8	03	M14-1.5	6	17	22
0084-03-16	3/16	4.8	03	M16-1.5	8	19	25
0084-04-14	1/4	6.4	04	M14-1.5	6	17	23
0084-04-16	1/4	6.4	04	M16-1.5	8	19	25
0084-04-18	1/4	6.4	04	M18-1.5	10	22	24
0084-04-20	1/4	6.4	04	M20-1.5	12	24	22
0084-05-16	5/16	7.9	05	M16-1.5	8	19	26
0084-05-18	5/16	7.9	05	M18-1.5	10	22	25
0084-05-20	5/16	7.9	05	M20-1.5	12	24	25
0084-06-18	3/8	9.5	06	M18-1.5	10	22	25
0084-06-20	3/8	9.5	06	M20-1.5	12	24	25
0084-06-22	3/8	9.5	06	M22-1.5	14	27	29
0084-06-24	3/8	9.5	06	M24-1.5	16	30	29
0084-08-20*	1/2	12.7	08	M20-1.5	12	27	28
0084-08-22	1/2	12.7	08	M22-1.5	14	27	17
0084-08-24	1/2	12.7	08	M24-1.5	16	30	30
0084-08-30	1/2	12.7	08	M30-2	20	36	33
0084-10-24*	5/8	15.9	10	M24-1.5	16	30	31
0084-10-30	5/8	15.9	10	M30-2	20	36	33
0084-12-30	3/4	19	12	M30-2	20	36	34
0084-12-36	3/4	19	12	M36-2	25	46	40
0084-16-36	1	25.4	16	M36-2	25	46	41
0084-16-42	1	25.4	16	M42-2	30	50	43
0084-20-52	1.1/4	31.8	20	M52-2	38	60	44
0084-24-52	1.1/2	38.1	24	M52-2	38	60	44

\*Rolled Nut

0184

## 90° Metric Swept Elbow 24° Seat Heavy

### (DKOS-90°)

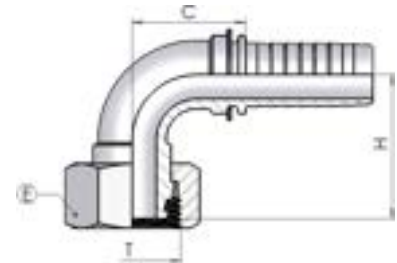

Product number	hose I.D.		Dimension					
	in	mm	dash size	T	erm.	E	H	Cut-off C
0184-03-16	3/16	4.8	03	M16-1.5	8	19	25	22
0184-04-14	1/4	6.4	04	M14-1.5	6	17	26	27
0184-04-16	1/4	6.4	04	M16-1.5	8	19	26	26
0184-04-18	1/4	6.4	04	M18-1.5	10	22	31	27
0184-04-20	1/4	6.4	04	M20-1.5	12	24	30	27
0184-05-18	5/16	7.9	05	M18-1.5	10	22	33	33
0184-05-20	5/16	7.9	05	M20-1.5	12	24	34	30
0184-06-18	3/8	9.5	06	M18-1.5	10	22	35	34
0184-06-20	3/8	9.5	06	M20-1.5	12	24	34	34
0184-06-22	3/8	9.5	06	M22-1.5	14	27	33	33
0184-06-24	3/8	9.5	06	M24-1.5	16	30	35	33
0184-08-20*	1/2	12.7	08	M20-1.5	12	27	48	40
0184-08-22	1/2	12.7	08	M22-1.5	14	27	41	40
0184-08-24	1/2	12.7	08	M24-1.5	16	30	41	40
0184-10-24*	5/8	15.9	10	M24-1.5	16	30	60	42
0184-10-30	5/8	15.9	10	M30-2	20	36	50	46
0184-12-30	3/4	19	12	M30-2	20	36	56	58
0184-12-36	3/4	19	12	M36-2	25	46	57	59
0184-16-36	1	25.4	16	M36-2	25	46	67	77
0184-16-42	1	25.4	16	M42-2	30	50	67	72
0184-20-52	1.1/4	31.8	20	M52-2	38	60	82	84
0184-24-52	1.1/2	38.1	24	M52-2	38	60	105	105

\*Rolled Nut

# 0284

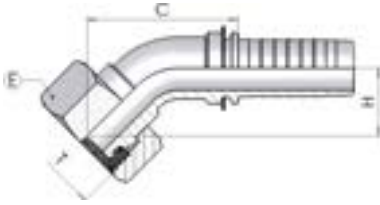

## 45° Metric Swept Elbow 24° Seat Heavy

**(DKOS-45°)**

Product number	hose I.D.		Dimension					
	in	mm	dash size	T	erm.	E	H	Cut-off C
0284-03-16	3/16	4.8	03	M16-1.5	8	19	16	36
0284-04-14	1/4	6.4	04	M14-1.5	6	17	15	37
0284-04-16	1/4	6.4	04	M16-1.5	8	19	15	42
0284-04-18	1/4	6.4	04	M18-1.5	10	22	18	45
0284-05-20	5/16	7.9	05	M20-1.5	12	24	19	49
0284-06-18	3/8	9.5	06	M18-1.5	10	22	19	51
0284-06-20	3/8	9.5	06	M20-1.5	12	24	18	53
0284-06-22	3/8	9.5	06	M22-1.5	14	27	20	54
0284-08-24	1/2	12.7	08	M24-1.5	16	30	21	63
0284-10-30	5/8	15.9	10	M30-2	20	36	29	74
0284-12-30	3/4	19	12	M30-2	20	36	30	87
0284-12-36	3/4	19	12	M36-2	25	46	29	56
0284-16-36	1	25.4	16	M36-2	25	46	30	85
0284-16-42	1	25.4	16	M42-2	30	50	30	85
0284-20-52	1.1/4	31.8	20	M52-2	38	60	39	105
0284-24-52	1.1/2	38.1	24	M52-2	38	60	53	129

0550

## Metric Standpipe

(BEL-BES)

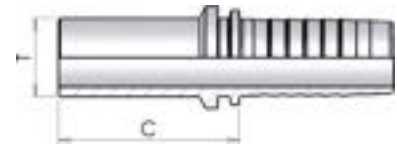

Product number	hose I.D.		Dimension			
	in	mm	dash size	Pipe T	Type	Cut-off C
0550-03-06	3/16	4.8	03	6	L/S	30
0550-03-08	3/16	4.8	03	8	L/S	29
0550-04-06	1/4	6.4	04	6	L/S	32
0550-04-08	1/4	6.4	04	8	L/S	30
0550-04-10	1/4	6.4	04	10	L/S	33
0550-04-12	1/4	6.4	04	12	L/S	30
0550-05-08	5/16	7.9	05	08	L/S	31
0550-05-10	5/16	7.9	05	10	L/S	31
0550-05-12	5/16	7.9	05	12	L/S	33
0550-06-08	3/8	9.5	06	08	L/S	33
0550-06-10	3/8	9.5	06	10	L/S	33
0550-06-12	3/8	9.5	06	12	L/S	32
0550-06-14	3/8	9.5	06	14	S	37
0550-06-15	3/8	9.5	06	15	L	32
0550-08-12	1/2	12.7	08	12	L/S	36
0550-08-14	1/2	12.7	08	14	S	39
0550-08-15	1/2	12.7	08	15	L	34
0550-08-16	1/2	12.7	08	16	S	39
0550-08-18	1/2	12.7	08	18	L	35
0550-08-20	1/2	12.7	08	20	S	45
0550-10-18	5/8	15.9	10	18	L	35
0550-10-20	5/8	15.9	10	20	S	45
0550-10-22	5/8	15.9	10	22	L	33
0550-12-18	3/4	19	12	18	L	37
0550-12-20	3/4	19	12	20	S	46
0550-12-22	3/4	19	12	22	L	38
0550-12-25	3/4	19	12	25	S	49
0550-12-28	3/4	19	12	28	L	40
0550-16-25	1	25.4	16	25	S	51
0550-16-28	1	25.4	16	28	L	41
0550-16-30	1	25.4	16	30	S	54
0550-16-38	1	25.4	16	38	S	60
0550-20-30	1.1/4	31.8	20	30	S	58
0550-20-35	1.1/4	31.8	20	35	L	48
0550-20-38	1.1/4	31.8	20	38	S	62
0550-24-38	1.1/2	38.1	24	38	S	63
0550-24-42	1.1/2	38.1	24	42	L	50

## 0650

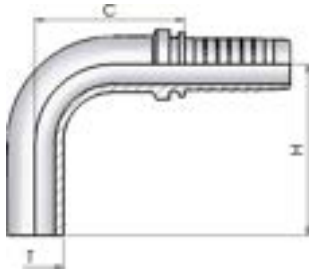

## 0650S

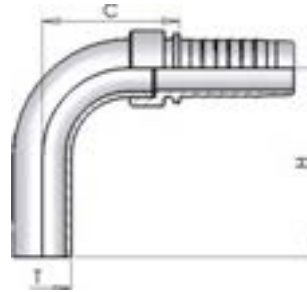

### 90° Metric Standpipe

#### (BEL-BES 90°)

Product number	hose I.D.		Dimension				
	in	mm	dash size	Pipe T	Type	H	Cut-off C
0650-03-06	3/16	4.8	03	6	L/S	32	20
0650S03-08	3/16	4.8	03	8	L/S	41	25
0650-04-06	1/4	6.4	04	6	L/S	32	23
0650-04-08	1/4	6.4	04	8	L/S	34	25
0650-04-10	1/4	6.4	04	10	L/S	43	25
0650S04-12	1/4	6.4	04	12	L/S	44	35
0650-05-10	5/16	7.9	05	10	L/S	40	29
0650-05-12	5/16	7.9	05	12	L/S	45	29
0650-06-10	3/8	9.5	06	10	L/S	40	27
0650-06-12	3/8	9.5	06	12	L/S	44	30
0650S06-15	3/8	9.5	06	15	L	52	39
0650S08-12	1/2	12.7	08	12	L/S	44	33
0650S08-15	1/2	12.7	08	15	L	52	39
0650S08-18	1/2	12.7	08	18	L	56	42
0650S10-18	5/8	15.9	10	18	L	56	51
0650S12-22	3/4	19	12	22	L	71	51
0650S12-25	3/4	19	12	25	S	75	57
0650S16-25	1	25.4	16	25	S	75	57
0650S16-28	1	25.4	16	28	L	89	60
0650S24-42	1.1/2	38.1	24	42	L	125	106

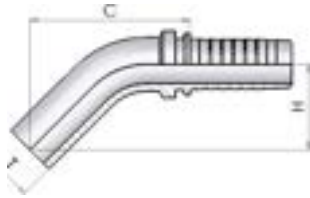
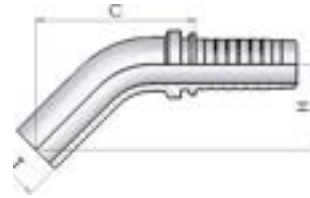

**0750****0750S****45° Metric Standpipe****(BEL-BES 45°)**

Product number	hose I.D.		Dimension				
	in	mm	dash size	Pipe T	Type	H	Cut-off C
0750-03-06	3/16	4.8	03	6	L/S	25	38
0750-04-06	1/4	6.4	04	6	L/S	24	41
0750-04-08	1/4	6.4	04	8	L/S	25	43
0750-04-10	1/4	6.4	04	10	L/S	30	47
0750-05-10	5/16	7.9	05	10	L/S	30	49
0750-06-10	3/8	9.5	06	10	L/S	33	50
0750-06-12	3/8	9.5	06	12	L/S	33	52
0750S08-12	1/2	12.7	08	12	L	29	51
0750S08-15	1/2	12.7	08	15	L	29	55
0750S08-18	1/2	12.7	08	18	L	29	56
0750S10-18	5/8	15.7	10	18	L	29	56
0750S12-22	3/4	19	12	22	L	35	65

# 0035

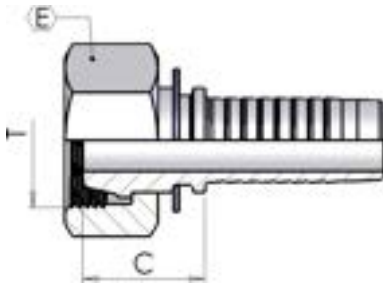

## Metric Female 24° Seat Light Multiseal

**(DKL)**

Product number	hose I.D.		Dimension				I.D.	
	in	dash size	mm	T	erm.	E	Cut-off C	
0035-03-12	3/16	03	4.8	M12-1.5	6	14	19	
0035-03-16	3/16	03	4.8	M16-1.5	10	19	18	
0035-04-14	1/4	04	6.4	M14-1.5	8	17	19	
0035-04-16	1/4	04	6.4	M16-1.5	10	19	19	
0035-05-16	5/16	05	7.9	M16-1.5	10	19	19	
0035-05-18	5/16	05	7.9	M18-1.5	12	22	21	
0035-06-16	3/8	06	9.5	M16-1.5	10	19	23	
0035-06-18	3/8	06	9.5	M18-1.5	12	22	23	
0035-06-22	3/8	06	9.5	M22-1.5	15	27	22	
0035-08-22	1/2	08	12.7	M22-1.5	15	27	22	
0035-08-26	1/2	08	12.7	M26-1.5	18	32	24	
0035-10-26	5/8	10	15.9	M26-1.5	18	32	24	
0035-12-30	3/4	12	19	M30-2	22	36	29	
0035-16-36	1	16	25.4	M36-2	28	41	30	

**0135**

## 90° Metric Swept Elbow 24° Seat Light Multiseal

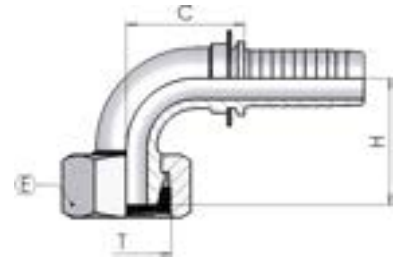
**(DKL-90°)**

Product number	hose I.D.		Dimension					I.D.
	in	dash size	mm	T	erm.	E	H	Cut-off C
0135-04-14	1/4	04	6.4	M14-1.5	8	17	25	25
0135-04-16	1/4	04	6.4	M16-1.5	10	19	24	26
0135-05-16	5/16	05	7.9	M16-1.5	10	19	29	32
0135-06-18	3/8	06	9.5	M18-1.5	12	22	30	36
0135-08-22	1/2	08	12.7	M22-1.5	15	27	38	41

# 0400

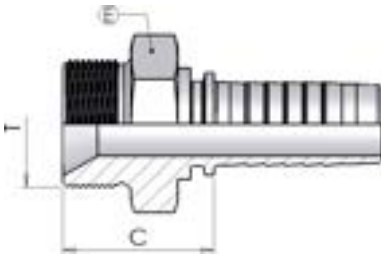

## Metric Male 60° cone

**(AGM)**

Product number	hose I.D.		I.D.	Dimension		
	in	mm		dash size	T	E
0400-03-10	3/16	4.8	03	M10-1	14	19
0400-03-12	3/16	4.8	03	M12-1.5	17	25
0400-04-14	1/4	6.4	04	M14-1.5	19	26
0400-05-16	5/16	7.9	05	M16-1.5	22	26
0400-05-18	5/16	7.9	05	M18-1.5	24	26
0400-06-14	3/8	9.5	06	M14-1.5	19	26
0400-06-16	3/8	9.5	06	M16-1.5	22	26
0400-06-18	3/8	9.5	06	M18-1.5	24	27
0400-08-18	1/2	12.7	08	M18-1.5	24	28
0400-08-22	1/2	12.7	08	M22-1.5	27	30
0400-10-26	5/8	15.9	10	M26-1.5	32	32
0400-12-30	3/4	19	12	M30-1.5	36	36
0400-16-38	1	25.4	16	M38-1.5	46	37
0400-20-45	1.1/4	31.8	20	M45-1.5	55	39

0100

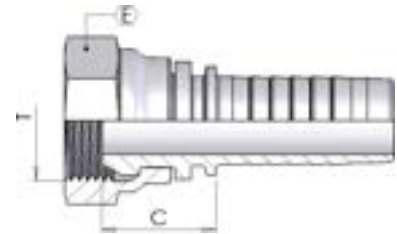
**Metric Female 60° cone****(DKM)**

Product number	hose I.D.	I.D.	Dimension			
	in	mm	dash size	T	E	Cut-off C
0100-03-10	3/16	4.8	03	M10-1	14	15
0100-04-10	1/4	6.4	04	M10-1	14	15
0100-04-14	1/4	6.4	04	M14-1.5	19	17
0100-05-14	5/16	7.9	05	M14-1.5	19	17
0100-05-16	5/16	7.9	05	M16-1.5	22	19
0100-05-18	5/16	7.9	05	M18-1.5	24	19
0100-06-14	3/8	9.5	06	M14-1.5	19	17
0100-06-16	3/8	9.5	06	M16-1.5	22	19
0100-06-18	1/2	12.7	08	M18-1.5	24	19
0100-08-18	1/2	12.7	08	M18-1.5	24	20
0100-08-20	1/2	12.7	08	M20-1.5	27	22.5
0100-08-22	1/2	12.7	08	M22-1.5	27	22.5
0100-10-26	5/8	15.9	10	M26-1.5	32	25
0100-12-30	3/4	19	12	M30-1.5	36	26
0100-16-38	1	25.4	16	M38-1.5	46	33
0100-20-45	1.1/4	31.8	20	M45-1.5	50	34
0100-24-52	1.1/2	38	24	M52x1.5	60	35
0100-32-65	2	50.8	32	M65-2	75	31

# 0200

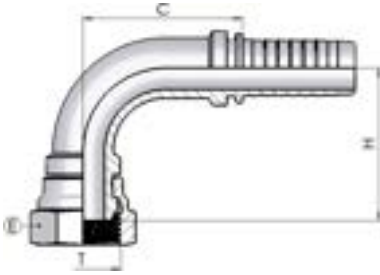

## 90° Metric Swept Elbow 60° cone

**(DKM-90°)**

Product number	hose I.D.		Dimension				I.D.
	in	dash size	mm	T	E	H	Cut-off C
0200-03-10	3/16	03	4.8	M10-1	14	23	22
0200-04-10	1/4	04	6.4	M10-1	14	25	24
0200-04-14	1/4	04	6.4	M14-1.5	19	26	24
0200-05-14	5/16	05	7.9	M14-1.5	19	31	29
0200-05-16	5/16	05	7.9	M16-1.5	22	35	29
0200-05-18	5/16	05	7.9	M18-1.5	24	35	29
0200-06-16	3/8	06	9.5	M16-1.5	22	34	33
0200-06-18	3/8	06	9.5	M18-1.5	24	34	33
0200-08-22	1/2	08	12.7	M22-1.5	27	40	41
0200-12-30	3/4	12	19	M30-1.5	36	36	57
0200-16-38	1	16	25.4	M38-1.5	46	71	70

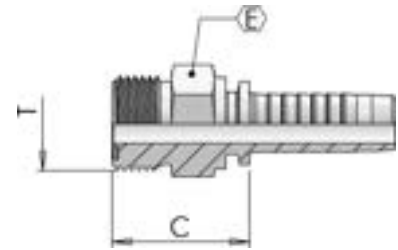
**S350****ORFS Male****(ORFS)**

Product number	hose I.D.		Dimension			
	in	mm	dash size	T	E	Cut-off C
S350-04-06-BO	1/4	6.4	04	9/16-18	17	23
S350-04-09-BO	1/4	6.4	04	11/16-16	19	21
S350-05-09-BO	5/16	7.9	05	11/16-16	19	26
S350-06-09-BO	3/8	9.5	06	11/16-16	19	26
S350-06-11-BO	3/8	9.5	6	13/16-16	22	29
S350-08-11-BO	1/2	12.7	08	13/16-16	22	29
S350-08-13-BO	1/2	12.7	08	1-14	27	34
S350-08-14-BO	1/2	12.7	08	1.3/16-12	32	35
S350-10-13-BO	5/8	15.9	10	1-14	27	33
S350-10-14-BO	5/8	15.9	10	1.3/16-12	32	35
S350-12-14-BO	3/4	19	12	1.3/16-12	32	36
S350-12-15-BO	3/4	19	12	1.7/16-12	38	36
S350-16-15-BO	1	25.4	16	1.7/16-12	38	37
S350-16-21-BO	1	25.4	16	1.11/16-12	46	38
S350-20-21-BO	1.1/4	31.8	20	1.11/16-12	46	39

- with plug and O-Ring

# S050

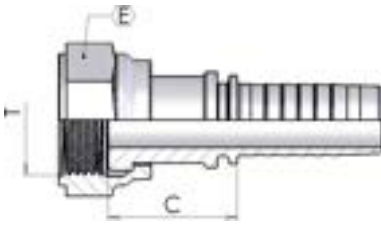

## ORFS Female

### (ORFS)

Product number	hose I.D.		I.D.	Dimension		
	in	mm		dash size	T	E
S050-04-06	1/4	6.4	04	9/16-18	19	25
S050-04-09	1/4	6.4	04	11/16-16	22	29
S050-05-09	5/16	7.9	05	11/16-16	22	29
S050-06-09	3/8	9.5	06	11/16-16	22	29
S050-06-11	3/8	9.5	06	13/16-16	24	30
S050-08-11	1/2	12.7	08	13/16-16	24	32
S050-08-13	1/2	12.7	08	1-14	30	35
S050-08-14	1/2	12.7	08	1.3/16-12	36	37
S050-10-13	5/8	15.9	10	1-14	30	35
S050-10-14	5/8	15.9	10	1.3/16-12	36	34
S050-12-13	3/4	19	12	1-14	30	37
S050-12-14	3/4	19	12	1.3/16-12	36	35
S050-12-15	3/4	19	12	1.7/16-12	41	41
S050-16-15	1	25.4	16	1.7/16-12	41	39
S050-20-21	1.1/4	31.8	20	1.11/16-12	50	40
S050-24-32	1.1/2	38.1	24	2-12	60	41

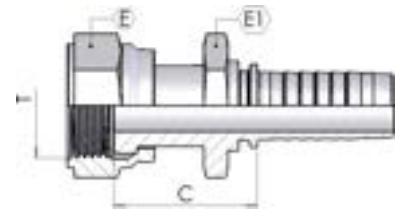

**S05T****ORFS Female Back Hexagon****(ORFS)**

Product number	hose I.D.		Dimension				I.D.
	in	dash size	mm	T	E	E1	Cut-off C
S05T-04-06	1/4	04	6.4	9/16-18	17	15	30
S05T-06-09	3/8	06	9.5	11/16-16	22	17	34
S05T-08-11	1/2	08	12.7	13/16-16	24	19	37
S05T-10-13	5/8	10	15.9	1-14	30	24	41
S05T-12-14	3/4	12	19	1.3/16-12	36	30	42
S05T-16-15	1	16	25.4	1.7/16-12	41	36	50

# S150

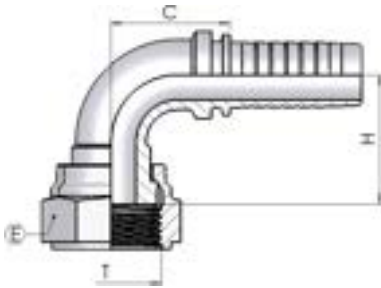

## ORFS 90° Swept Elbow

**(ORFS-90°)**

Product number	hose I.D.		Dimension				I.D.
	in	dash size	mm	T	E	H	Cut-off C
S150-04-06	1/4	04	6.4	9/16-18	19	26	25
S150-04-09	1/4	04	6.4	11/16-16	22	23	25
S150-05-09	5/16	05	7.9	11/16-16	22	32	29
S150-06-09	3/8	06	9.5	11/16-16	22	33	33
S150-06-11	3/8	06	9.5	13/16-16	24	32	33
S150-08-11	1/2	08	12.7	13/16-16	24	36	43
S150-08-13	1/2	08	12.7	1-14	30	40	39
S150-08-14	1/2	08	12.7	1.3/16-12	36	39	42
S150-10-13	5/8	10	15.9	1-14	30	42	44
S150-10-14	5/8	10	15.9	1.3/16-12	36	39	42
S150-12-13	3/4	12	19	1-14	30	39	42
S150-12-14	3/4	12	19	1.3/16-12	36	49	57
S150-12-15	3/4	12	19	1.7/16-12	41	51	56
S150-16-15	1	16	25.4	1.7/16-12	41	62	67
S150-16-21	1	20	25.4	1.11/16-12	50	58	62
S150-20-21	1.1/4	20	31.8	1.11/16-12	50	58	63
S150-24-32	1.1/2	24	38.1	2-12	60	73	80

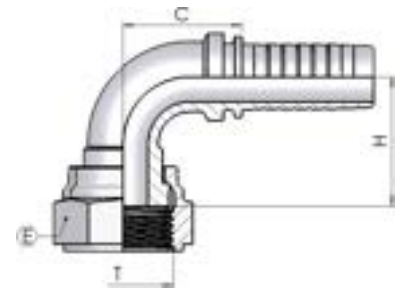
**S15S****ORFS 90° Swept Elbow - ISO SHORT****(ORFS-90°)**

Product number	hose I.D.		Dimension				I.D.
	in	dash size	mm	T	E	H	Cut-off C
S15S-04-06	1/4	04	6.4	9/16-18	19	21	25
S15S-06-09	3/8	06	9.5	11/16-16	22	23	33
S15S-08-11	1/2	08	12.7	13/16-16	24	29	43
S15S-08-13	1/2	08	12.7	1-14	30	32	39
S15S-10-13	5/8	10	15.9	1-14	30	32	47
S15S-12-14	3/4	12	19	1.3/16-12	36	48	57
S15S-16-15	1	16	25.4	1.7/16-12	41	56	67

## S250

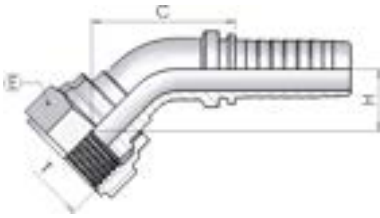

### ORFS 45° Swept Elbow

### (ORFS-45°)

Product number	hose I.D.		Dimension				
	in	mm	dash size	T	E	H	Cut-off C
S250-04-06	1/4	6.4	04	9/16-18	19	14	40
S250-04-09	1/4	6.4	04	11/16-16	22	14	38
S250-05-09	5/16	7.9	05	11/16-16	22	14	44
S250-06-09	3/8	9.5	06	11/16-16	22	17	52
S250-06-11	3/8	9.5	06	13/16-16	24	18	51
S250-08-11	1/2	12.7	08	13/16-16	24	20	62
S250-08-13	1/2	12.7	08	1-14	30	23	64
S250-08-14	1/2	12.7	08	1.3/16-12	36	17	44
S250-10-13	5/8	15.9	10	1-14	30	22	67
S250-10-14	5/8	15.9	10	1.3/16-12	36	18	44
S250-12-13	3/4	19	12	1-14	30	15	40
S250-12-14	3/4	19	12	1.3/16-12	36	23	84
S250-12-15	3/4	19	12	1.7/16-12	41	26	84
S250-16-15	1	25.4	16	1.7/16-12	41	27	101
S250-20-21	1.1/4	31.8	20	1.11/16-12	50	44	125
S250-24-32	1.1/2	38.1	24	2-12	60	29	78

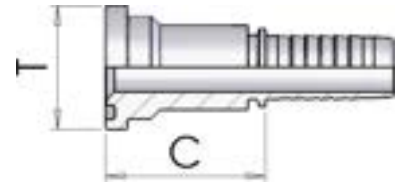
**1260****Straight SAE Flange 3000 PSI****(SFL)**

Product number	hose I.D.		Dimension			
	in	mm	dash size	T Flange	mm	Cut-off C
1260-08-08	1/2	12.7	08	1/2	30,2	45
1260-08-12	1/2	12.7	08	3/4	38.1	50
1260-10-08	5/8	15.9	10	1/2	30,2	45
1260-10-10	5/8	15.9	10	5/8	34	56
1260-10-12	5/8	15.9	10	3/4	38.1	49
1260-12-12	3/4	19	12	3/4	38.1	50
1260-12-16	3/4	19	12	1	44.5	53
1260-16-16	1	25.4	16	1	44.5	54
1260-16-20	1	25.4	16	1.1/4	50.8	57
1260-20-20	1.1/4	31.8	20	1.1/4	50.8	59
1260-20-24	1.1/4	31.8	20	1.1/2	60.3	62
1260-24-24	1.1/2	38.1	24	1.1/2	60.3	62
1260-24-32	1.1/2	38.1	24	2	71.4	67
1260-32-32	2	50.8	32	2	71.4	68
1260-32-40	2	50.8	32	2.1/2	84.1	76
1260-40-40	2.1/2	63,5	40	2.1/2	84	76
1260-48-48	3	76,2	48	3	102	63

# 1060

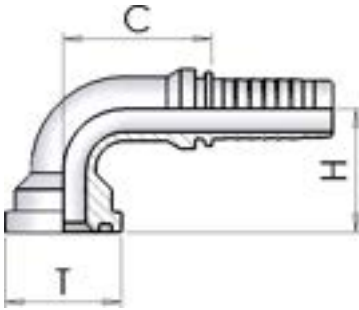

## 90° SAE Flange 3000 PSI

(SFL 90°)

Product number	hose I.D.		Dimension				
	in	dash size	mm	T Flange	mm	drop H	Cut-off C
1060-08-08	1/2	08	12.7	1/2	30,2	39	39
1060-08-12	1/2	08	12.7	3/4	38.1	44	42
1060-10-08	5/8	10	15.9	1/2	30,2	42	45
1060-10-12	5/8	10	15.9	3/4	38.1	47	45
1060-12-12	3/4	12	19	3/4	38.1	53	56
1060-12-16	3/4	12	19	1	44.5	58	56
1060-16-16	1	16	25.4	1	44.5	65	70
1060-16-20	1	16	25.4	1.1/4	50.8	70	67
1060-16-24	1	16	25.4	1.1/2	60.3	71	72
1060-20-16	1.1/4	20	31.8	1	44.5	73	83
1060-20-20	1.1/4	20	31.8	1.1/4	50.8	79	85
1060-20-24	1.1/4	20	31.8	1.1/2	60.3	81	85
1060-24-24	1.1/2	24	38.1	1.1/2	60.3	89	98
1060-24-32	1.1/2	24	38.1	2	71.4	90	102
1060-32-32	2	32	50.8	2	71.4	113	134

# 1160

## 45° SAE Flange 3000 PSI

(SFL 45°)

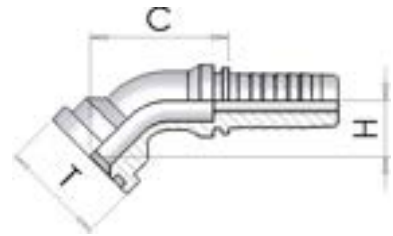

Product number	hose I.D.		Dimension				
	in	mm	dash size	T Flange	mm	H	Cut-off C
1160-08-08	1/2	12.7	08	1/2	30.2	22	62
1160-08-12	1/2	12.7	08	3/4	38.1	25	67
1160-12-12	3/4	19	12	3/4	38.1	25	69
1160-12-16	3/4	19	12	1	44.5	30	88
1160-16-16	1	25.4	16	1	44.5	29	82
1160-20-20	1.1/4	31.8	20	1.1/4	50.8	38	102
1160-20-24	1.1/4	31.8	20	1.1/2	60.3	39	106
1160-24-24	1.1/2	38.1	24	1.1/2	60.3	44	114
1160-24-32	1.1/2	38.1	24	2	71.4	40	115
1160-32-32	2	50.8	32	2	71.4	58	135

# FS3L

## 90° SAE Flange 3000 Psi - Long Drop

(SFL 90° L)

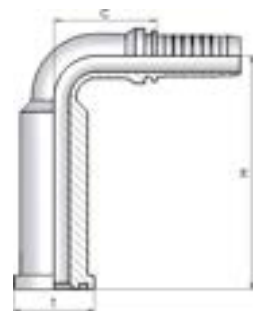

Product number	hose I.D.		Dimension				
	in	dash size	mm	T Flange	mm	drop H	Cut-off C
FS3L-12-12	3/4	12	19	3/8	38.1	123	56
FS3L-16-16	1	16	25.4	1	44.5	127	70
FS3L-20-20	1.1/4	20	31.8	1.1/4	50.8	178	85

# S003

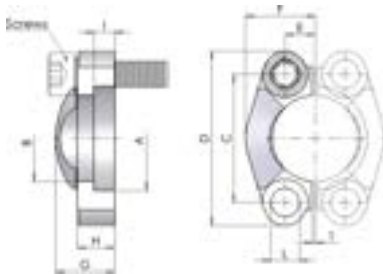

## Cut Split Flanges - 3000 psi

Product number	SAE	Dimension									
	size	A	B	C	D	E	F	G	H	I	L
S003-08	1/2"	30.96	24.3	38.1	54	8.7	22.8	19	13	6.2	8.8
S003-12	3/4"	38.89	32.1	47.6	65	11.1	25.9	22	14	6.2	10.8
S003-16	1"	45.24	38.5	52.4	70	13.1	29.2	24	16	7.5	10.8
S003-20	1.1/4"	51.59	43.7	58.7	79	15.1	36.3	22	14	7.5	12
S003-24	1.1/2"	61.09	50.8	69.9	94	17.9	41.1	25	16	7.5	13.5
S003-32	2"	72.24	62.7	77.8	102	21.4	48.2	26	16	9	13.5
S003-40	2.1/2"	84.94	74.9	88.9	114	25.4	54.1	38	19	9	13.5

This product is sold in pairs

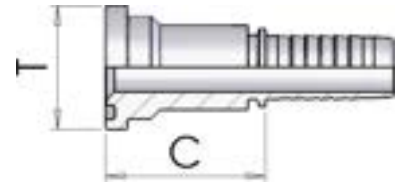

**1310****Straight SAE Flange 6000 PSI****(SFS)**

Product number	hose I.D.		Dimension			
	in	mm	dash size	T Flange	mm	Cut-off C
1310-08-08	1/2	12.7	08	1/2	31,8	46
1310-08-12	1/2	12.7	08	3/4	41.3	53
1310-10-08	5/8	15.9	10	1/2	31,8	46
1310-10-12	5/8	15.9	10	3/4	41.3	53
1310-12-12	3/4	19	12	3/4	41.3	54
1310-12-16	3/4	19	12	1	47.6	60
1310-16-12	1	25.4	16	3/4	41.3	55
1310-16-16	1	25.4	16	1	47.6	61
1310-16-20	1	25.4	16	1.1/4	54	68
1310-20-20	1.1/4	31.8	20	1.1/4	54	70
1310-20-24	1.1/4	31.8	20	1.1/2	63.5	76
1310-24-24	1.1/2	38.1	24	1.1/2	63.5	76
1310-24-32	1.1/2	38.1	24	2	79.4	85
1310-32-32	2	50.8	32	2	79.4	85

# 1110

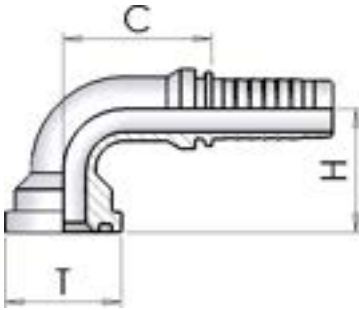

## 90° SAE Flange 6000 PSI

(SFS 90°)

Product number	hose I.D.		Dimension				
	in	mm	dash size	T Flange	mm	drop H	Cut-off C
1110-08-08	1/2	12.7	08	1/2	31.8	39	39
1110-08-12	1/2	12.7	08	3/4	41.3	48	39
1110-10-08	5/8	15.9	10	1/2	31.8	42	45
1110-10-12	5/8	15.9	10	3/4	41.3	52	44
1110-12-12	3/4	19	12	3/4	41.3	55	56
1110-12-16	3/4	19	12	1	47.6	63	56
1110-16-12	1	25.4	16	3/4	41.3	64	68
1110-16-16	1	25.4	16	1	47.6	69	70
1110-16-20	1	25.4	16	1.1/4	54	74	71
1110-20-20	1.1/4	31.8	20	1.1/4	54	83	97
1110-20-24	1.1/4	31.8	20	1.1/2	63.5	93	97
1110-24-24	1.1/2	38.1	24	1.1/2	63.5	103	100
1110-32-32	2	50.8	32	2	79.4	136	125

## 1210

### 45° SAE Flange 6000 PSI

(SFS 45°)

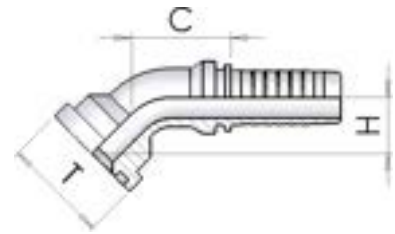

Product number	hose I.D.		Dimension				
	in	mm	dash size	T Flange	mm	drop H	Cut-off C
1210-08-08	1/2	12.7	08	1/2	31.8	22	62
1210-08-12	1/2	12.7	08	3/4	41.3	28	69
1210-10-08	5/8	15.9	10	1/2	31.8	21	66
1210-10-12	5/8	15.9	10	3/4	41.3	27	75
1210-12-12	3/4	19	12	3/4	41.3	28	74
1210-12-16	3/4	19	12	1	47.6	32	90
1210-16-12	1	25.4	16	3/4	41.3	29	94
1210-16-16	1	25.4	16	1	47.6	34	86
1210-16-20	1	25.4	16	1.1/4	54	37	90
1210-20-20	1.1/4	31.8	20	1.1/4	54	41	111
1210-20-24	1.1/4	31.8	20	1.1/2	63.5	48	118
1210-24-24	1.1/2	38.1	24	1.1/2	63.5	50	122
1210-32-32	2	50.8	32	2	79.4	58	151

## FS6L

### 90° SAE Flange 6000 Psi - Long Drop

(SFS 90° L)

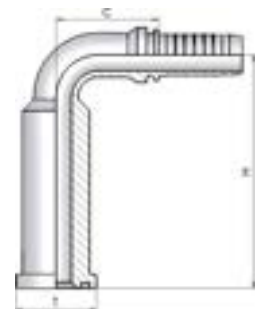

Product number	hose I.D.		Dimension				
	in	mm	dash size	T Flange	mm	drop H	Cut-off C
FS6L-08-08	1/2	12.7	08	1/2	32	75	40
FS6L-12-12	3/4	19	12	3/4	41.3	126	56
FS6L-16-16	1	25.4	16	1	47.6	132	70
FS6L-20-20	1.1/4	31.8	20	1.1/4	54	185	82

## S006

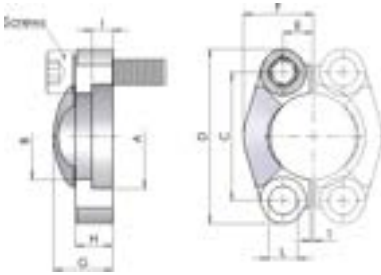

### Cut Split Flanges - 6000 psi

Product number	SAE	Dimension									
	size	A	B	C	D	E	F	G	H	I	L
S006-08	1/2"	32.54	24.6	40.5	56	9.1	23.6	22	16	7.2	8.8
S006-12	3/4"	42.06	32.5	50.8	71	11.9	30	28	19	8.3	11
S006-16	1"	48.41	38.9	57.2	81	13.9	34.8	33	24	9	13
S006-20	1 1/4"	54.76	44.5	66.7	95	15.9	38.6	38	27	9.8	15
S006-24	1 1/2"	64.29	51.6	79.4	113	18.3	47.5	43	30	12.1	17
S006-32	2"	80.16	67.6	96.8	133	22.2	56.9	52	37	12.1	21

This product is sold in pairs

## 130S

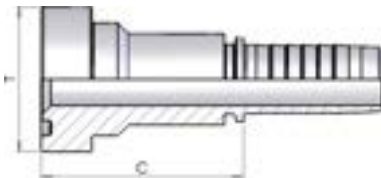

### Straight 'CAT' Flange

(SFC)

Product number	hose I.D.	I.D.	Dimension			
	in	mm	dash size	T Flange	mm	Cut-off C
130S-12-12	3/4	19	12	3/4	41.3	58
130S-12-16	3/4	19	12	1	47.6	64
130S-16-16	1	25.4	16	1	47.6	65
130S-16-20	1	25.4	16	1 1/4	54	73
130S-20-20	1 1/4	31.8	20	1 1/4	54	74
130S-24-24	1 1/2	38.1	24	1 1/2	63.5	80

## 110S

### 90° 'CAT' Flange

(SFC 90°)

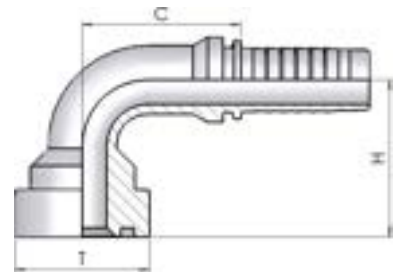

Product number	hose I.D.		Dimension				
	in	mm	dash size	T Flange	mm	H	Cut-off C
110S-12-12	3/4	19	12	3/4	41.3	62	56
110S-12-16	3/4	19	12	1	47.6	65	56
110S-16-16	1	25.4	16	1	47.6	74	78
110S-16-20	1	25.4	16	1.1/4	54	80	78
110S-20-20	1.1/4	31.8	20	1.1/4	54	90	97
110S-20-24	1.1/4	31.8	20	1.1/2	63.5	95	96
110S-24-24	1.1/2	38.1	24	1.1/2	63.5	104	115

## 120S

### 45° 'CAT' Flange

(SFC 45°)

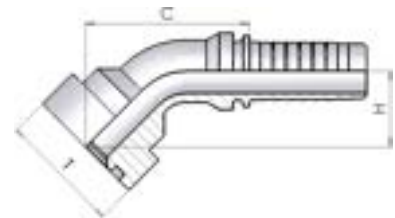

Product number	hose I.D.		Dimension				
	in	mm	dash size	T Flange	mm	H	Cut-off C
120S-12-12	3/4	19	12	3/4	41.3	32	88
120S-12-16	3/4	19	12	1	47.6	37	93
120S-16-16	1	25.4	16	1	47.6	37	90
120S-16-20	1	25.4	16	1.1/4	54	44	122
120S-20-20	1.1/4	31.8	20	1.1/4	54	43	114
120S-20-24	1.1/4	31.8	20	1.1/2	63.5	48	119
120S-24-24	1.1/2	38.1	24	1.1/2	63.5	52	172

## 1250

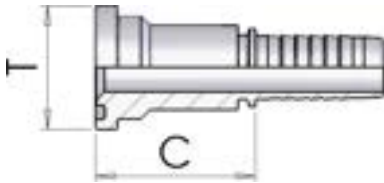

### Komatsu Flange - Straight

(JIS-KF)

Product number	hose I.D.		Dimension			
	in	mm	dash size	T Flange	mm	Cut-off C
1250-10-10	5/8	15.9	10	5/8	34	56

## 1050

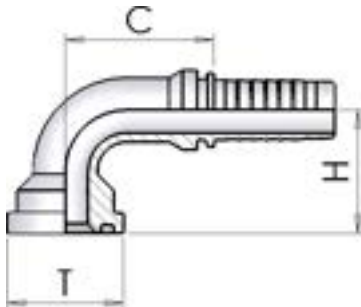

### Komatsu Flange 90°

(JIS-KF)

Product number	hose I.D.		Dimension				
	in	dash size	mm	T Flange	mm	drop H	Cut-off C
1050-10-10	5/8	10	15.9	5/8	34	47	58

## 1150

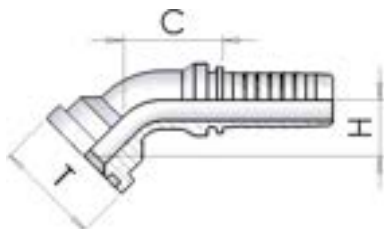

### Komatsu Flange 45°

(JIS-KF)

Product number	hose I.D.		Dimension				
	in	dash size	mm	T Flange	mm	drop H	Cut-off C
1150-10-10	5/8	10	15.9	5/8	34	54	23

0940

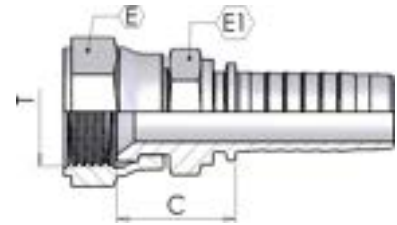
**JIS Female 60° Cone (Komatsu)****(JIS-K)**

Product number	hose I.D.		Dimension				
	in	mm	dash size	T	E	E1	Cut-off C
0940-04-14	1/4	6.4	04	M14x1,5	19	17	22
0940-05-16	5/16	7.9	05	M16x1,5	22	17	22
0940-06-14	3/8	9.5	06	M14x1,5	19	17	22
0940-06-16	3/8	9.5	06	M16x1,5	22	19	22
0940-06-18	3/8	9.5	06	M18x1,5	24	19	21
0940-08-22	1/2	12.7	08	M22x1,5	27	22	27
0940-08-24	1/2	12.7	08	M24x1,5	30	27	25
0940-10-24	5/8	15.9	10	M24x1,5	30	27	26
0940-12-30	3/4	19	12	M30x1,5	36	30	30
0940-16-33	1	25.4	16	M33x1,5	41	36	33
0940-20-36	1.1/4	31.8	20	M36x1,5	46	46	37
0940-24-42	1.1/2	38.1	24	M42x1,5	50	50	38

## 0990S

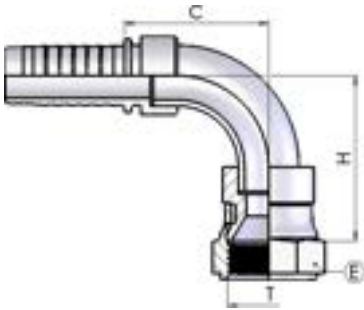

### 90° JIS Swept Elbow (Komatsu) - welded

(JIS-K 90°)

Product number	hose I.D.		dash size	Dimension			
	in	mm		T	E	H	Cut-off C
0990S04-14	1/4	6.4	04	M14x1,5	19	35	38
0990S05-16	5/16	7.9	05	M16x1,5	22	30	27
0990S06-14	3/8	9.5	06	M14x1,5	19	33	31
0990S06-18	3/8	9.5	06	M18x1,5	24	33	31
0990S08-22	1/2	12.7	08	M22x1,5	27	39	33
0990S10-24	5/8	15.9	10	M24x1,5	30	48	42
0990S12-30	3/4	19	12	M30x1,5	36	43	48
0990S16-33	1	25.4	16	M33x1,5	41	62	57

## 0930

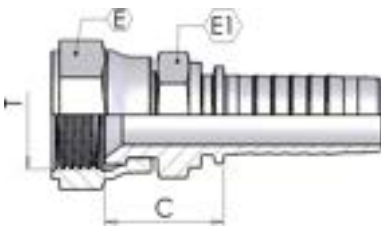

### JIS Female 60° cone (Toyota)

(JIS-T)

Product number	hose I.D.		dash size	Dimension			
	in	mm		T	E	E1	Cut-off C
0930-04-04	1/4	6.4	04	1/4-19	19	17	20
0930-06-06	3/8	9.5	06	3/8-19	22	19	22
0930-08-08	1/2	12.7	08	1/2-14	27	22	26
0930-12-12	3/4	19	12	3/4-14	32	30	29
0930-16-16	1	25.4	16	1-11	38	36	31
0930-20-20	1,1/4	31.8	20	1,1/4-11	50	46	35
0930-24-24	1,1/2	38.1	24	1,1/2-11	55	50	28

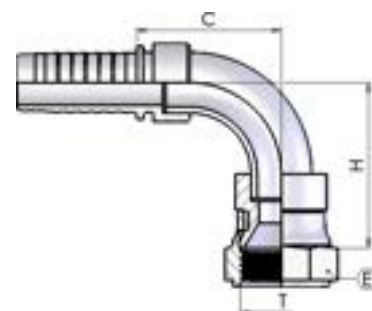

**0980S****90° JIS Swept Elbow (Toyota) -  
welded****(JIS-T 90°)**

Product number	hose I.D.		dash size	Dimension				Cut-off C
	in	mm		T	E	H		
0980S04-04	1/4	6.4	04	1/4-19	19	35	38	
0980S06-06	3/8	9.5	06	3/8-19	22	30	27	
0980S08-08	1/2	12.7	08	1/2-14	27	39	33	
0980S12-12	3/4	19	12	3/4-14	32	55	48	
0980S16-16	1	25.4	16	1-11	38	62	57	

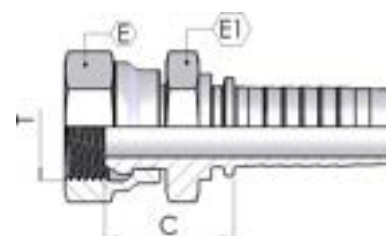
**0920****JIS Female 60° cone (Nissan)****(JIS-N)**

Product number	hose I.D.		dash size	Dimension				Cut-off C
	in	mm		T	E	E1		
0920-04-04	1/4	6.4	04	1/4-19	19	19	23	
0920-06-06	3/8	9.5	06	3/8-19	22	22	28	
0920-08-08	1/2	12.7	08	1/2-14	27	27	27	

## 0030

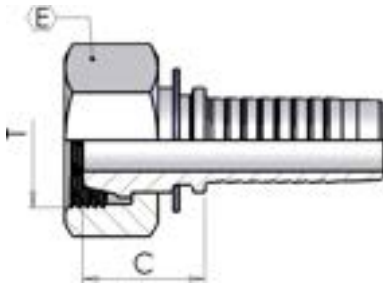

### Metric Female 24° Cone French Type

(DKF)

Product number	hose I.D.		Dimension			
	in	I.D. mm	dash size	T	E	Cut-off C
0030-05-20	5/16	7.9	05	M20-1.5	24	25
0030-06-20	3/8	9.5	06	M20-1.5	24	26
0030-08-24	1/2	12.7	08	M24-1.5	30	28
0030-10-30	5/8	15.9	10	M30-1.5	36	25
0030-12-30	3/4	19	12	M30-1.5	36	26
0030-12-36	3/4	19	12	M36-1.5	46	29
0030-16-45	1	25.4	16	M45-1.5	55	30
0030-20-52	1.1/4	31.8	20	M52-1.5	65	34

## FK50

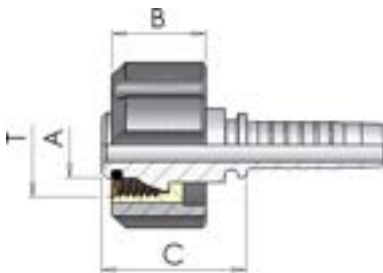

K' Female

Product number	hose I.D.		Dimension				I.D. Cut-off C
	in	dash size	mm	T	A	B	
FK50-04-22	1/4	04	6.4	M22-1.5	14	20	31
FK50-05-22	5/16	05	7.9	M22-1.5	14	20	31
FK50-06-22	3/8	06	9.5	M22-1.5	14	20	31
FK50-04022	1/4	04	6.4	M22-1.5	14	27	31
FK50-05022	5/16	05	7.9	M22-1.5	14	27	31
FK50-06022	3/8	06	9.5	M22-1.5	14	27	31

## FN50

### 'K' Male ( for gun) - Diameter 10

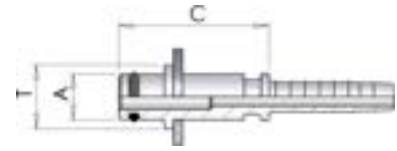

Product number	hose I.D.		Dimension		
	in	mm	dash size	A	C
FN50-04-22	1/4	6.4	04	10	33
FN50-05-22	5/16	7.9	05	10	33
FN50-06-22	3/8	9.5	06	10	33

## FN51

### 'K' Male ( for gun) - Diameter 11

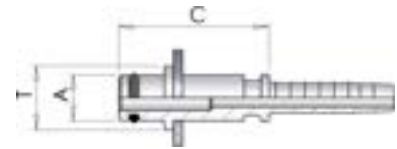

Product number	hose I.D.		Dimension		
	in	mm	dash size	A	C
FN51-04-22	1/4	6.4	04	11	33
FN51-05-22	5/16	7.9	05	11	33

# 1400

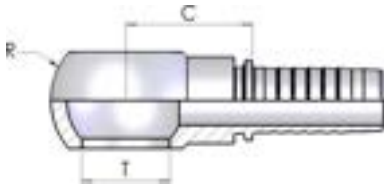

## BSP Banjo

Product number	hose I.D.		Dimension				
	in	mm	dash size	hole T	mm	R	Cut-off C
1400-03-02	3/16	4.8	03	1/8-28	10.2	17	19
1400-03-04	3/16	4.8	03	1/4-19	13.3	24	26
1400-04-02	1/4	6.4	04	1/8-28	10.2	17	25
1400-04-04	1/4	6.4	04	1/4-19	13.3	24	26
1400-04-06	1/4	6.4	04	3/8-19	17	28	26
1400-05-04	5/16	7.9	05	1/4-19	13.3	24	26
1400-05-06	5/16	7.9	05	3/8-19	17	28	26
1400-06-04	3/8	9.5	06	1/4-19	13.3	24	26
1400-06-06	3/8	9.5	06	3/8-19	17	28	26
1400-06-08	3/8	9.5	06	1/2-14	21.2	36	31
1400-08-06	1/2	12.7	08	3/8-19	17	28	27
1400-08-08	1/2	12.7	08	1/2-14	21.2	36	31
1400-08-12	1/2	12.7	08	3/4-14	26.5	45	38
1400-10-12	5/8	15.9	10	3/4-14	26.5	45	38
1400-12-12	3/4	19	12	3/4-14	26.5	45	38
1400-12-16	3/4	19	12	1-11	33.5	58	49
1400-16-16	1	25.4	16	1-11	33.5	58	50

## 1600

### Double BSP Perforded Bolt

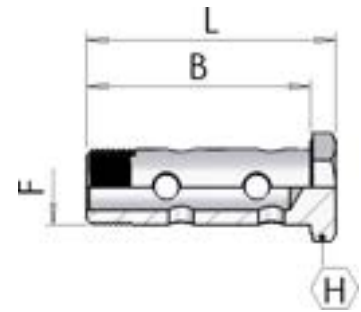

Product number	Dimension			
	F	B	L	H
1600-04-04	1/4-19	43	49	19
1600-06-06	3/8-19	49	57	22
1600-08-08	1/2-14	62	70	27
1600-12-12	3/4-14	78	87	32
1600-16-16	1-11	98	109	41

## 1600-00

### BSP Perforded Bolt

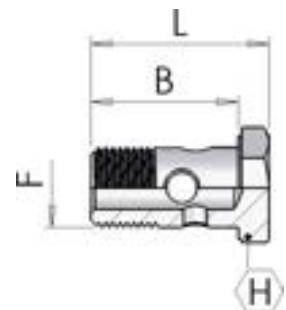

Product number	Dimension			
	F	B	L	H
1600-00-02	1/8-28	19	24	14
1600-00-04	1/4-19	29	34	19
1600-00-06	3/8-19	33	41	22
1600-00-08	1/2-14	38	46	27
1600-00-12	3/4-14	47	56	32
1600-00-16	1-11	58	69	41

# 1350

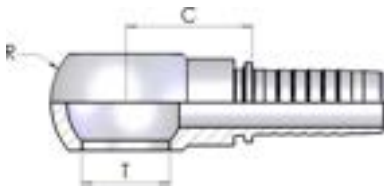

## Metric Banjo

Product number	hose I.D.		Dimension				
	in	mm	dash size	hole T	mm	R	Cut-off C
1350-03-10	3/16	4.8	03	M10-1	10.2	17	25
1350-03-12	3/16	4.8	03	M12-1.5	12.2	20	22
1350-04-10	1/4	6.4	04	M10-1	10.2	17	25
1350-04-12	1/4	6.4	04	M12-1.5	12.2	20	22
1350-04-14	1/4	6.4	04	M14-1.5	14.2	24	26
1350-05-14	5/16	7.9	05	M14-1.5	14.2	24	26
1350-05-16	5/16	7.9	05	M16-1.5	16.2	28	26
1350-05-18	5/16	7.9	05	M18-1.5	18.2	32	29
1350-06-14	3/8	9.5	06	M14-1.5	14.2	24	26
1350-06-16	3/8	9.5	06	M16-1.5	16.2	28	26
1350-06-18	3/8	9.5	06	M18-1.5	18.2	32	29
1350-06-22	3/8	9.5	06	M22-1.5	22.2	36	31
1350-08-16	1/2	12.7	08	M16-1.5	16.2	28	27
1350-08-18	1/2	12.7	08	M18-1.5	18.2	32	29
1350-08-22	1/2	12.7	08	M22-1.5	22.2	36	31
1350-10-22	5/8	15.9	10	M22-1.5	22.2	36	31
1350-10-26	5/8	15.9	10	M26-1.5	26.5	45	38
1350-12-22	3/4	19	12	M22-1.5	22.2	36	32
1350-12-26	3/4	19	12	M26-1.5	26.2	46	38
1350-16-30	1	25.4	16	M30-2	30.2	54	45

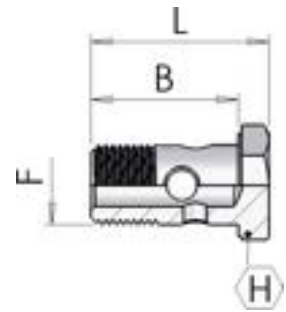
**1650****Metric perforated bolt**

Product number	Dimension			
	F	B	L	H
1650-00-10	M10-1	19	24	14
1650-00-12	M12-1.5	26	31	17
1650-00-14	M14-1.5	29	34	19
1650-00-16	M16-1.5	33	41	22
1650-00-18	M18-1.5	37	44	24
1650-00-22	M22-1.5	38	46	27
1650-00-26	M26-1.5	47	56	32
1650-00-30	M30-1.5	58	68	36

**D050****Hose Junction**

Product number	hose I.D.		I.D.		Dimension	
	in	mm	dash size	Cut-off C		
D050-03	3/16	4.8	03	17		
D050-04	1/4	6.4	04	22		
D050-05	5/16	7.9	05	22		
D050-06	3/8	9.5	06	22		
D050-08	1/2	12.7	08	23		
D050-10	5/8	15.9	10	18		
D050-12	3/4	19	12	19		
D050-16	1	25.4	16	21		
D050-20	1.1/4	31.8	20	24		
D050-24	1.1/2	38.1	24	24		
D050-32	2	50.8	32	26		



## GS00

## Weldable Fitting

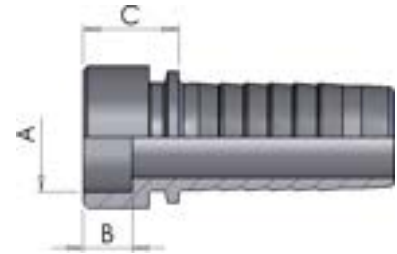

Product number	I.D.		Dimension			
	hose I.D. in	I.D. mm	dash size	A	B	Cut-off C
GS00-03-08	3/16	4,8	03	08	6	12
GS00-04-06	1/4	6.4	04	06	6	14
GS00-04-08	1/4	6.4	04	08	6	14
GS00-04-10	1/4	6.4	04	10	6	15
GS00-04-12	1/4	6.4	04	12	7	17
GS00-05-08	5/16	7,9	05	08	6	14
GS00-05-10	5/16	7,9	05	10	6	14
GS00-05-12	5/16	7,9	05	12	6	14
GS00-06-06	3/8	9.5	06	06	6	15
GS00-06-08	3/8	9.5	06	08	6	15
GS00-06-10	3/8	9.5	06	10	6	14
GS00-06-12	3/8	9.5	06	12	7	15
GS00-06-15	3/8	9.5	06	15	7	14
GS00-08-12	1/2	12.7	08	12	7	15
GS00-08-14	1/2	12.7	08	14	8	15
GS00-08-15	1/2	12.7	08	15	7	15
GS00-08-16	1/2	12.7	08	16	7	15
GS00-08-20	1/2	12.7	08	20	9	18
GS00-10-16	5/8	15.9	10	16	8	16
GS00-10-18	5/8	15.9	10	18	8	16
GS00-10-20	5/8	15.9	10	20	9	18
GS00-12-16	3/4	19	12	16	8	16
GS00-12-18	3/4	19	12	18	8	16
GS00-12-20	3/4	19	12	20	9	18
GS00-12-22	3/4	19	12	22	9	18
GS00-12-25	3/4	19	12	25	9	19
GS00-16-25	1	25.4	16	25	9	19
GS00-16-30	1	25.4	16	30	9	20
GS00-20-35	1.1/4	31.8	20	35	11	23

without zinc plating

N Tail

in!



**0N14**



Swaged Ferrule 4WS (no skive)

**90**

**0N16**



Swaged Ferrule (no skive)

**90**

**0370N**



NPTF Male 60° cone

**91**

**0350N**



BSP Male Parallel 60° cone

**91**

**0050N 0051N**



BSP Female 60° Cone

**92**

**0150N 0151N**



BSP 90° Swept elbow 60° cone

**93**

**0250N 0251N**



BSP 45° Swept Elbow 60° Cone

**94**

**0500N**



Metric Male 24° Seat Light

**95**

**0085N**



Metric Female 24° Seat Light

**96**

**0185N**



90° Metric Swept Elbow 24° Seat Light

**96**

**0285N**



45° Metric Swept Elbow 24° Seat Light

**97**

**0450N**



Metric Male 24° Seat Heavy

**97**

**0084N**



Metric Female 24° Seat Heavy

**98**

**0184N**



90° Metric Swept Elbow 24° Seat Heavy

**98**

**0284N**



45° Metric Swept Elbow 24° Seat Heavy

**99**

**0850N**



JIC Male 74° cone

**100**

**0900N 0901N**



JIC Female 74° Cone-  
Double Hexagon

**101**

**0950N 0951N**



JIC 90° Swept Elbow 74°  
cone

**102**

**095SN**



JIC 90° Swept Elbow 74°  
cone - ISO SHORT

**102**

**1000N 1001N**



JIC 45° Swept Elbow 74°

**103**

**S350N**



ORFS Male

**104**

**S05TN**



ORFS Female Back  
Hexagon

**104**

**S150N**



ORFS 90° Swept Elbow

**105**

**S15SN**



ORFS 90° Swept Elbow -  
ISO SHORT

**105**

**S250N**



ORFS 45° Swept Elbow

**106**

**1250N**



Straight SAE Flange  
3000 PSI

**106**

**1050N**



90° SAE Flange 3000 PSI

**107**

**1150N**



45° SAE Flange 3000 PSI

**107**

**1300N**



Straight SAE Flange  
6000 PSI

**108**

**1100N**



90° SAE Flange 6000 PSI

**108**

**1200N**



45° SAE Flange 6000 PSI

**109**

**130SN**



Straight 'CAT' Flange

**109**

**110SN**



90° 'CAT' Flange

**110**

**120SN**



45° 'CAT' Flange

**111**

## ONI4



### Swaged Ferrule 4WS (no skive)

Product number	hose I.D.	I.D.	Dimension		skive	valid for
	in	mm	D	L	Length	-
ONI4-06	3/8	9.5	30.5	37	NO	SR-ISO
ONI4-08	1/2	12.7	33,5	37,5	NO	SR-ISO
ONI4-10	5/8	15.9	37.5	46	NO	SR-ISO
ONI4-12	3/4	19	44.5	50.5	NO	SR-ISO
ONI4-16	1	25.4	52.5	59.5	NO	SR-ISO
ONI4-20	1.1/4	31.8	60.5	70	NO	SR-ISO
ONI4-24	1.1/2	38.1	69.5	80	NO	SR-ISO

## ONI6



### Swaged Ferrule (no skive)

Product number	hose I.D.	I.D.	Dimension		skive	valid for
	in	mm	D	L	Length	-
ONI6-20	1.1/4	31.8	63.5	70	NO	SR-ISO
ONI6-24	1.1/2	38.1	72.5	80	NO	SR-ISO

## 0370N

### NPTF Male 60° cone

(AGN)

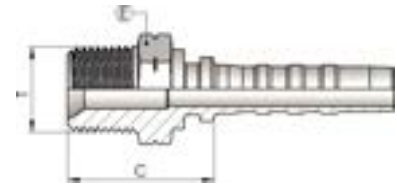

Product number	hose I.D.		Dimension			
	in	mm	dash size	Cut-off C	T	E
0370N06-06	3/8	9.5	06	30	3/8-18	19
0370N06-08	3/8	9.5	06	36	1/2-14	22
0370N08-08	1/2	12.7	08	36	1/2-14	22
0370N12-12	3/4	19	12	39	3/4-14	27
0370N16-16	1	25.4	16	46	1-11.1/2	36
0370N20-20	1.1/4	31.8	20	50	1.1/4-11.1/2	46
0370N24-24	1.1/2	38.1	24	54	1.1/2-11.1/2	50

## 0350N

### BSP Male Parallel 60° cone

(AGR)

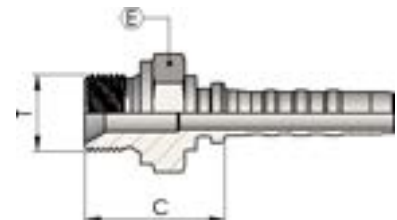

Product number	hose I.D.		Dimension				I.D.
	in	dash size	mm	T	E	Cut-off C	
0350N06-06	3/8	06	9.5	3/8-19	22	31	
0350N06-08	3/8	06	9.5	1/2-14	27	34	
0350N08-08	1/2	08	12.7	1/2-14	27	34	
0350N10-10	5/8	10	15.9	5/8-14	30	37	
0350N10-12	5/8	10	15.9	3/4-14	32	37	
0350N12-12	3/4	12	19	3/4-14	32	38	
0350N12-16	3/4	12	19	1-11	41	41	
0350N16-16	1	16	25.4	1-11	41	42	
0350N16-20	1	16	25.4	1.1/4-11	50	46	
0350N20-20	1.1/4	20	31.8	1.1/4-11	50	48	
0350N24-24	1.1/2	24	38.1	1.1/2-11	55	51	

## 0050N 0051N

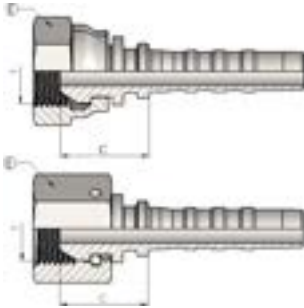

**BSP Female 60° Cone**

**(DKR)**

Product number	hose I.D.		Dimension			
	in	mm	dash size	Thread T	hex E	Cut-off C
0051N06-06	3/8	9.5	06	3/8-19	22	21
0051N06-08	3/8	9.5	06	1/2-14	23	24
0051N08-08	1/2	12.7	08	1/2-14	27	24
0051N10-10	5/8	15.9	10	5/8-14	30	22
0050N10-12	5/8	15.9	10	3/4-14	32	27
0050N12-12	3/4	19	12	3/4-14	32	27
0050N12-16	3/4	19	12	1-11	41	28
0050N16-16	1	25.4	16	1-11	41	30
0050N20-20	1.1/4	31.8	20	1.1/4-11	50	34
0050N20-24	1.1/4	31.8	20	1.1/2-11	55	36
0050N24-24	1.1/2	38.1	24	1.1/2-11	55	39

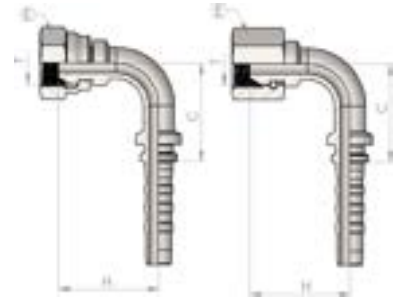

**0150N 0151N****BSP 90° Swept elbow 60° cone**

Product number	hose I.D.	I.D.	Dimension				
	in	mm	dash size	T	E	H	Cut-off C
0151N06-06	3/8	9.5	06	3/8-19	22	35	33
0151N06-08	3/8	9.5	06	1/2-14	27	40	31
0151N08-08	1/2	12.7	08	1/2-14	27	41	39
0151N10-10	5/8	15.9	10	5/8-14	30	43	44
0150N10-12	5/8	15.9	10	3/4-14	32	50	45
0150N12-12	3/4	19	12	3/4-14	32	57	58
0150N16-16	1	25.4	16	1-11	41	70	75
0150N16-20	1	25.4	16	1.1/4-11	50	76	77
0150N20-20	1.1/4	31.8	20	1.1/4-11	50	84	98
0150N24-24	1.1/2	38.1	24	1.1/2-11	55	104	110

## 0250N 0251N

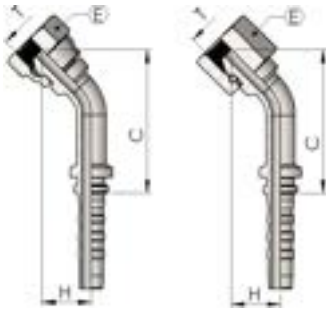

### BSP 45° Swept Elbow 60° Cone

**(DKR-45°)**

Product number	hose I.D.		Dimension				
	in	mm	dash size	T	E	H	C
0251N06-06	3/8	9.5	06	3/8-19	22	19	54
0251N06-08	3/8	9.5	06	1/2-14	27	21	57
0251N08-08	1/2	12.7	08	1/2-14	27	24	66
0251N10-10	5/8	15.9	10	5/8-14	30	23	70
0250N10-12	5/8	15.9	10	3/4-14	32	27	74
0250N12-12	3/4	19	12	3/4-14	32	28	88
0250N16-16	1	25.4	16	1-11	41	38	116
0250N16-20	1	25.4	16	1.1/4-11	50	33	70
0250N20-20	1.1/4	31.8	20	1.1/4-11	50	41	103
0250N24-24	1.1/2	38.1	24	1.1/2-11	55	54	172

## 0500N

## Metric Male 24° Seat Light

(CEL)

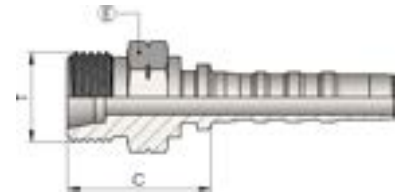

Product number	hose I.D.		Dimension				I.D.
	in	dash size	mm	T	erm.	E	Cut-off C
0500N06-16	3/8	06	9.5	M16-1.5	10	17	23
0500N06-18	3/8	06	9.5	M18-1.5	12	19	24
0500N06-22	3/8	06	9.5	M22-1.5	15	22	25
0500N08-18	1/2	08	12.7	M18-1.5	12	19	25
0500N08-22	1/2	08	12.7	M22-1.5	15	22	26
0500N08-26	1/2	08	12.7	M26-1.5	18	27	27
0500N10-22	5/8	10	15.9	M22-1.5	15	22	26
0500N10-26	5/8	10	15.9	M26-1.5	18	27	27
0500N10-30	5/8	10	15.9	M30-2	22	30	32
0500N12-26	3/4	12	19	M26-1.5	18	27	28
0500N12-30	3/4	12	19	M30-2	22	30	33
0500N16-36	1	16	25.4	M36-2	28	36	32
0500N20-45	1.1/4	20	31.8	M45-2	35	46	36
0500N24-52	1.1/2	24	38.1	M52-2	42	55	38

## 0085N

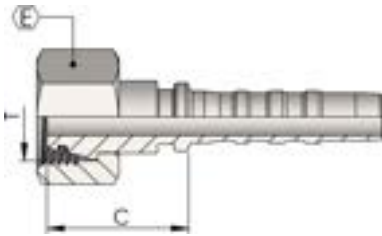

### Metric Female 24° Seat Light

(DKOL)

Product number	hose I.D.		Dimension					I.D.
	in	dash size	mm	T	erm.	E	Cut-off C	
0085N06-18	3/8	06	9.5	M18-1.5	12	22	27	
0085N08-22	1/2	08	12.7	M22-1.5	15	27	30	
0085N10-26	5/8	10	15.9	M26-1.5	18	32	31	
0085N12-30	3/4	12	19	M30-2	22	36	31	
0085N16-36	1	16	25.4	M36-2	28	41	32	
0085N20-45	1.1/4	20	31.8	M45-2	35	50	43	
0085N24-52	1.1/2	24	38.1	M52-2	42	60	46	

## 0185N

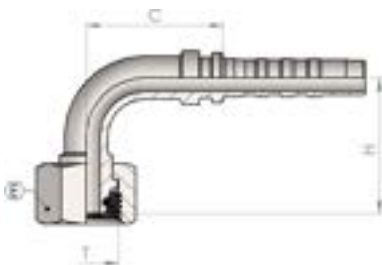

### 90° Metric Swept Elbow 24° Seat Light

(DKOL-90°)

Product number	hose I.D.		Dimension					
	in	mm	dash size	T	erm.	E	H	Cut-off C
0185N06-18	3/8	9.5	06	M18-1.5	12	22	33	34
0185N08-22	1/2	12.7	08	M22-1.5	15	27	41	41
0185N10-26	5/8	15.9	10	M26-1.5	18	32	44	44
0185N12-30	3/4	19	12	M30-2	22	36	52	58
0185N16-36	1	25.4	16	M36-2	28	41	62	72
0185N20-45	1.1/4	31.8	20	M45-2	35	50	73	63
0185N24-52	1.1/2	38.1	24	M52-2	42	60	83	81

## 0285N

### 45° Metric Swept Elbow 24° Seat Light

(DKOL-45°)

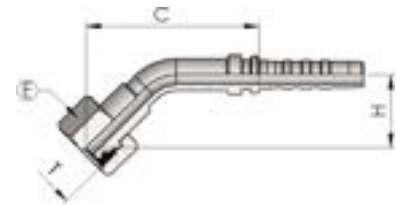

Product number	hose I.D.		Dimension					
	in	mm	dash size	T	erm.	E	H	Cut-off C
0285N06-18	3/8	9.5	06	M18-1.5	12	22	19	52
0285N08-22	1/2	12.7	08	M22-1.5	15	27	21	63
0285N10-26	5/8	15.9	10	M26-1.5	18	32	23	68
0285N16-36	1	25.4	16	M36-2	28	41	29	104
0285N20-45	1.1/4	31.8	20	M45-2	35	50	34	72
0285N24-52	1.1/2	38.1	24	M52-2	42	60	36	85

## 0450N

### Metric Male 24° Seat Heavy

(CES)

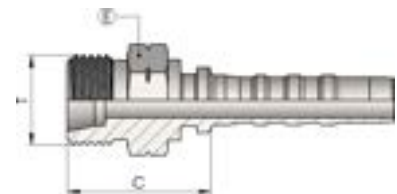

Product number	hose I.D.		Dimension				
	in	mm	dash size	T	erm.	E	Cut-off C
0450N06-20	3/8	9.5	06	M20-1.5	12	22	31
0450N08-24	1/2	12.7	08	M24-1.5	16	24	33
0450N10-30	5/8	15.9	10	M30-2	20	30	36
0450N12-30	3/4	19	12	M30-2	20	30	37
0450N12-36	3/4	19	12	M36-2	25	36	39
0450N16-42	1	25.4	16	M42-2	30	46	44
0450N20-52	1.1/4	31.8	20	M52-2	38	55	48
0450N24-52	1.1/2	38.1	24	M52-2	38	55	50

## 0084N

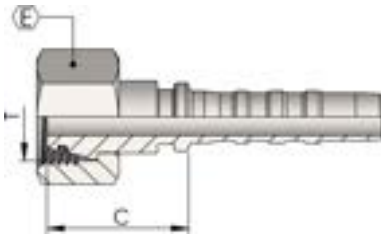

### Metric Female 24° Seat Heavy

(DKOS)

Product number	hose I.D.		Dimension				
	in	mm	dash size	T	erm.	E	Cut-off C
0084N06-20	3/8	9.5	06	M20-1.5	12	24	25
0084N08-24	1/2	12.7	08	M24-1.5	16	30	29
0084N10-30	5/8	15.9	10	M30-2	20	34	34
0084N12-30	3/4	19	12	M30-2	20	36	36
0084N12-36	3/4	19	12	M36-2	25	46	41
0084N16-36	1	25.4	16	M36-2	25	46	42
0084N16-42	1	25.4	16	M42-2	30	50	44
0084N20-52	1.1/4	31.8	20	M52-2	38	60	46
0084N24-52	1.1/2	38.1	24	M52-2	38	60	52

## 0184N

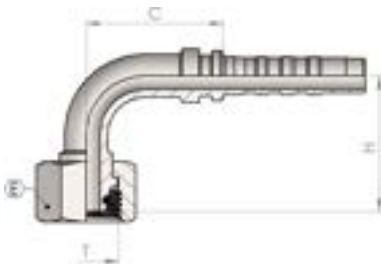

### 90° Metric Swept Elbow 24° Seat Heavy

(DKOS-90°)

Product number	hose I.D.		Dimension					
	in	mm	dash size	T	erm.	E	H	Cut-off C
0184N06-20	3/8	9.5	06	M20-1.5	12	24	34	34
0184N08-24	1/2	12.7	08	M24-1.5	16	30	41	40
0184N10-30	5/8	15.9	10	M30-2	20	36	50	46
0184N12-30	3/4	19	12	M30-2	20	36	56	58
0184N12-36	3/4	19	12	M36-2	25	46	57	59
0184N16-36	1	25.4	16	M36-2	25	46	67	77
0184N16-42	1	25.4	16	M42-2	30	50	67	72
0184N20-52	1.1/4	31.8	20	M52-2	38	60	82	84
0184N24-52	1.1/2	38.1	24	M52-2	38	60	105	105

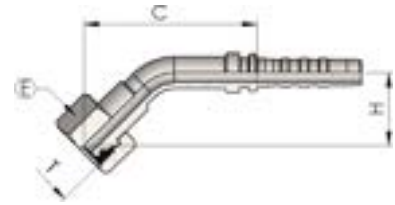
**0284N****45° Metric Swept Elbow 24° Seat  
Heavy****(DKOS-45°)**

Product number	hose I.D.		I.D.	Dimension				
	in	mm		dash size	T	erm.	E	H
0284N06-20	3/8	9.5	06	M20-1.5	12	24	18	53
0284N08-24	1/2	12.7	08	M24-1.5	16	30	21	63
0284N10-30	5/8	15.9	10	M30-2	20	36	29	74
0284N12-30	3/4	19	12	M30-2	20	36	30	87
0284N12-36	3/4	19	12	M36-2	25	46	29	56
0284N16-36	1	25.4	16	M36-2	25	46	34	105
0284N16-42	1	25.4	16	M42-2	30	50	30	85
0284N20-52	1.1/4	31.8	20	M52-2	38	60	39	105
0284N24-52	1.1/2	38.1	24	M52-2	38	60	53	129

# 0850N

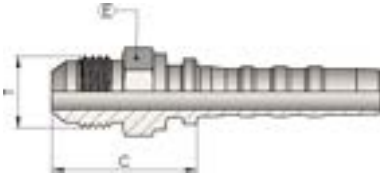

**JIC Male 74° cone**

**(AGJ)**

Product number	hose I.D.		I.D.	Dimension		
	in	mm		dash size	T	E
0850N06-06	3/8	9.5	06	9/16-18	15	29
0850N06-08	3/8	9.5	06	3/4-16	19	32
0850N08-08	1/2	12.7	08	3/4-16	19	32
0850N08-10	1/2	12.7	08	7/8-14	24	36
0850N08-12	1/2	12.7	08	1.1/16-12	27	38
0850N10-10	5/8	15.9	10	7/8-14	24	37
0850N12-12	3/4	19	12	1.1/16-12	27	40
0850N16-16	1	25.4	16	1.5/16-12	34	45
0850N20-20	1.1/4	31.8	20	1.5/8-12	42	50
0850N24-24	1.1/2	38.1	24	1.7/8-12	55	52

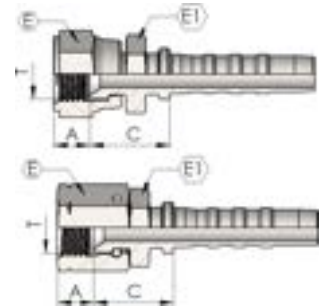

**0900N 0901N****JIC Female 74° Cone- Double  
Hexagon****(DKJ)**

Product number	hose I.D.		Dimension					
	in	mm	dash size	T	E	E1	C	A
0901N06-06	3/8	9.5	06	9/16-18	19	17	26	9
0901N06-08	3/8	9.5	06	3/4-16	24	19	28	10.5
0901N08-08	1/2	12.7	08	3/4-16	24	22	28	10.5
0901N08-10	1/2	12.7	08	7/8-14	27	22	28	13
0900N08-12	1/2	12.7	08	1.1/16-12	32	27	33	13.5
0901N10-10	5/8	15.9	10	7/8-14	27	22	28	13
0900N12-12	3/4	19	12	1.1/16-12	32	27	34	13.5
0900N16-16	1	25.4	16	1.5/16-12	38	36	35	15.5
0900N20-20	1.1/4	31.8	20	1.5/8-12	50	46	42	16.5
0900N24-24	1.1/2	38.1	24	1.7/8-12	55	50	46	19

## 0950N 0951N

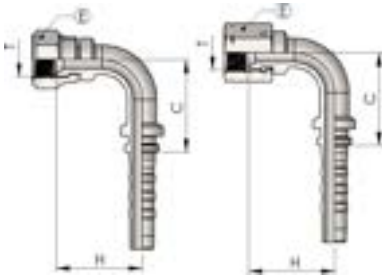

### JIC 90° Swept Elbow 74° cone

Product number	hose I.D.		Dimension				
	in	mm	dash size	T	E	H	C
0951N06-06	3/8	9.5	06	9/16-18	19	32	31
0951N06-08	3/8	9.5	06	3/4-16	24	34	35
0951N08-08	1/2	12.7	08	3/4-16	24	41	41
0951N08-10	1/2	12.7	08	7/8-14	27	40	41
0950N08-12	1/2	12.7	08	1.1/16-12	32	43	39
0950N10-10	5/8	15.9	10	7/8-14	27	45	42
0950N12-12	3/4	19	12	1.1/16-12	32	54	56
0950N16-16	1	25.4	16	1.5/16-12	41	65	70
0950N20-20	1.1/4	31.8	20	1.5/8-12	50	85	82
0950N24-24	1.1/2	38.1	24	1.7/8-12	55	97	104

## 095SN

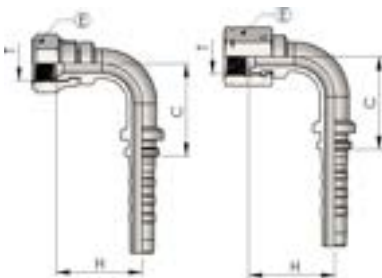

### JIC 90° Swept Elbow 74° cone - ISO SHORT

Product number	hose I.D.		Dimension				
	in	mm	dash size	T	E	H	C
095SN06-06	3/8	9.5	06	9/16-18	19	23	31
095SN08-08	1/2	12.7	08	3/4-16	24	29	41
095SN10-10	5/8	15.9	10	7/8-14	27	32	42
095SN12-12*	3/4	19	12	1.1/16-12	32	48	56

\*Thrust Wire Nut

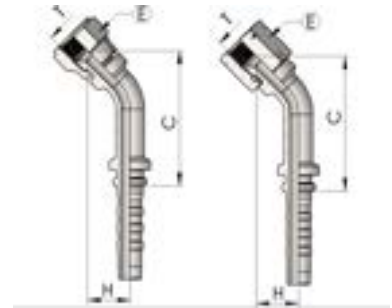
**1000N 1001N****JIC 45° Swept Elbow 74°****(DKJ-45°)**

Product number	hose I.D.		Dimension				
	in	mm	dash size	T	E	H	C
1001N06-06	3/8	9.5	06	9/16-18	19	17	51
1001N06-08	3/8	9.5	06	3/4-16	24	19	51
1001N08-08	1/2	12.7	08	3/4-16	24	22	62
1001N08-10	1/2	12.7	08	7/8-14	27	23	64
1000N08-12	1/2	12.7	08	1.1/16-12	32	25	68
1001N10-10	5/8	15.9	10	7/8-14	27	24	68
1000N12-12	3/4	19	12	1.1/16-12	32	28	84
1000N16-16	1	25.4	16	1.5/16-12	41	32	83
1000N20-20	1.1/4	31.8	20	1.5/8-12	50	42	108
1000N24-24	1.1/2	38.1	24	1.7/8-12	55	49	156

## S350N

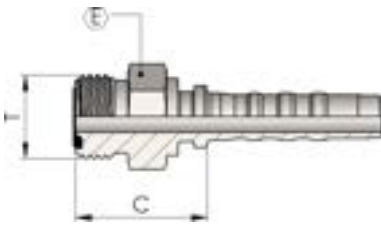

### ORFS Male

(ORFS)

Product number	hose I.D.		Dimension			
	in	mm	dash size	T	E	Cut-off C
S350N06-09	3/8	9.5	06	11/16-16	19	26
S350N06-11	3/8	9.5	6	13/16-16	22	29
S350N08-11	1/2	12.7	08	13/16-16	22	29
S350N10-13	5/8	15.9	10	1-14	27	33
S350N12-14	3/4	19	12	1.3/16-12	32	36
S350N16-15	1	25.4	16	1.7/16-12	38	37
S350N16-21	1	25.4	16	1.11/16-12	46	38
S350N20-21	1.1/4	31.8	20	1.11/16-12	46	39
S350N20-32	1.1/4	31.8	20	2-12	55	48.5
S350N24-32	1.1/2	38.1	24	2-12	55	52.5

- with plug and O-Ring

## S05TN

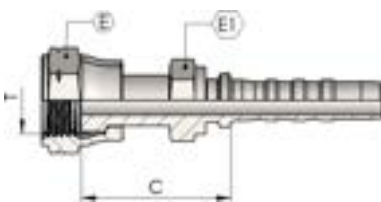

### ORFS Female Back Hexagon

(ORFS)

Product number	hose I.D.		Dimension				I.D. Cut-off C
	in	dash size	mm	T	E	E1	
S05TN06-09	3/8	06	9.5	11/16-16	22	17	36
S05TN06-11	3/8	06	9.5	13/16-16	24	19	38
S05TN08-11	1/2	08	12.7	13/16-16	24	19	38
S05TN10-13	5/8	10	15.9	1-14	30	24	43
S05TN12-14	3/4	12	19	1.3/16-12	36	30	44
S05TN16-15	1	16	25.4	1.7/16-12	41	36	52
S05TN20-21	1.1/4	20	31.8	1.11/16-12	50	46	56
S05TN24-32	1.1/2	24	38.1	2-21	60	50	62

## S150N

### ORFS 90° Swept Elbow

(ORFS-90°)

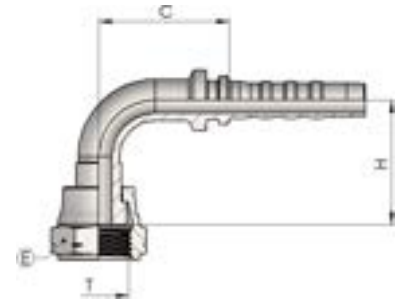

Product number	hose I.D.		Dimension				I.D.
	in	dash size	mm	T	E	H	Cut-off C
S150N06-09	3/8	06	9.5	11/16-16	22	33	33
S150N06-11	3/8	06	9.5	13/16-16	24	32	33
S150N08-11	1/2	08	12.7	13/16-16	24	36	43
S150N10-13	5/8	10	15.9	1-14	30	42	46
S150N12-14	3/4	12	19	1.3/16-12	36	49	57
S150N16-15	1	16	25.4	1.7/16-12	41	62	67
S150N16-21	1	20	25.4	1.11/16-12	50	58	62
S150N20-21	1.1/4	20	31.8	1.11/16-12	50	58	63
S150N20-32	1.1/4	20	31.8	2-12	60	73	63
S150N24-32	1.1/2	24	38.1	2-12	60	73	80

## S155N

### ORFS 90° Swept Elbow - ISO SHORT

(ORFS-90°)

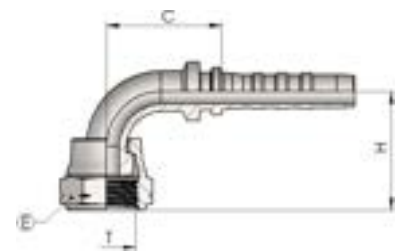

Product number	hose I.D.		Dimension				I.D.
	in	dash size	mm	T	E	H	Cut-off C
S155N04-06	1/4	04	6.4	9/16-18	19	21	25
S155N06-09	3/8	06	9.5	11/16-16	22	23	35
S155N08-11	1/2	08	12.7	13/16-16	24	29	44
S155N10-13	5/8	10	15.9	1-14	30	32	48
S155N12-14	3/4	12	19	1.3/16-12	36	48	58

## S250N

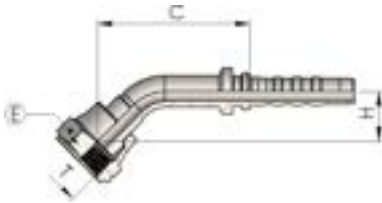

### ORFS 45° Swept Elbow

(ORFS-45°)

Product number	hose I.D.		Dimension				
	in	mm	dash size	T	E	H	Cut-off C
S250N06-09	3/8	9.5	06	11/16-16	22	17	52
S250N06-11	3/8	9.5	06	13/16-16	24	18	51
S250N08-11	1/2	12.7	08	13/16-16	24	20	62
S250N10-13	5/8	15.9	10	1-14	30	22	67
S250N12-14	3/4	19	12	1.3/16-12	36	23	84
S250N16-15	1	25.4	16	1.7/16-12	41	27	101
S250N20-21	1.1/4	31.8	20	1.11/16-12	50	44	125
S250N20-32	1.1/4	31.8	20	2-12	60	44	125
S250N24-32	1.1/2	38.1	24	2-12	60	44	127

## 1250N

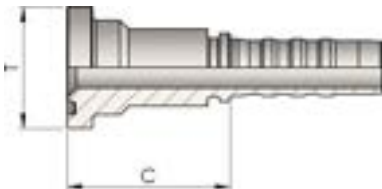

### Straight SAE Flange 3000 PSI

(SFL)

Product number	hose I.D.		Dimension			
	in	mm	dash size	T Flange	mm	Cut-off C
1250N08-08	1/2	12.7	08	1/2	30,2	48
1250N12-12	3/4	19	12	3/4	38.1	54
1250N12-16	3/4	19	12	1	44.5	55
1250N16-16	1	25.4	16	1	44.5	56
1250N16-20	1	25.4	16	1.1/4	50.8	59
1250N20-20	1.1/4	31.8	20	1.1/4	50.8	62
1250N20-24	1.1/4	31.8	20	1.1/2	60.3	65
1250N24-24	1.1/2	38.1	24	1.1/2	60.3	67
1250N24-32	1.1/2	38.1	24	2	71.4	72

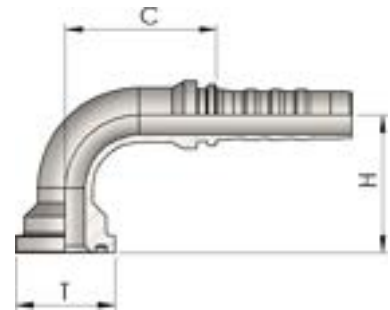
**1050N****90° SAE Flange 3000 PSI****(SFL 90°)**

Product number	hose I.D.		Dimension				
	in	dash size	mm	T Flange	mm	drop H	Cut-off C
1050N08-08	1/2	08	12.7	1/2	30.2	39	40
1050N12-12	3/4	12	19	3/4	38.1	53	58
1050N12-16	3/4	12	19	1	44.5	58	58
1050N16-16	1	16	25.4	1	44.5	65	72
1050N16-20	1	16	25.4	1.1/4	50.8	70	72
1050N20-20	1.1/4	20	31.8	1.1/4	50.8	82	96.5
1050N20-24	1.1/4	20	31.8	1.1/2	60.3	85	96
1050N24-24	1.1/2	24	38.1	1.1/2	60.3	94	117

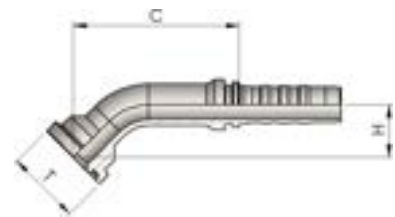
**1150N****45° SAE Flange 3000 PSI****(SFL 45°)**

Product number	hose I.D.		Dimension				
	in	mm	dash size	T Flange	mm	drop H	Cut-off C
1150N12-12	3/4	19	12	3/4	38.1	25	81
1150N12-16	3/4	19	12	1	44.5	28	86
1150N16-16	1	25.4	16	1	44.5	32	79
1150N16-20	1	25.4	16	1.1/4	50.8	37	113
1150N20-20	1.1/4	31.8	20	1.1/4	50.8	39	103
1150N20-24	1.1/4	31.8	20	1.1/2	60.3	39	107
1150N24-24	1.1/2	38.1	24	1.1/2	60.3	44	159

## 1300N

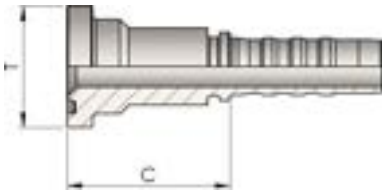

### Straight SAE Flange 6000 PSI

(SFS)

Product number	hose I.D.		Dimension			
	in	mm	dash size	T Flange	mm	Cut-off C
1300N08-08	1/2	12.7	08	1/2	31,8	47
1300N12-12	3/4	19	12	3/4	41.3	56
1300N12-16	3/4	19	12	1	47.6	62
1300N16-16	1	25.4	16	1	47.6	63
1300N16-20	1	25.4	16	1.1/4	54	71
1300N20-20	1.1/4	31.8	20	1.1/4	54	73
1300N20-24	1.1/4	31.8	20	1.1/2	63.5	79
1300N24-24	1.1/2	38.1	24	1.1/2	63.5	81
1300N24-32	1.1/2	38.1	24	2	79.4	90

## 1100N

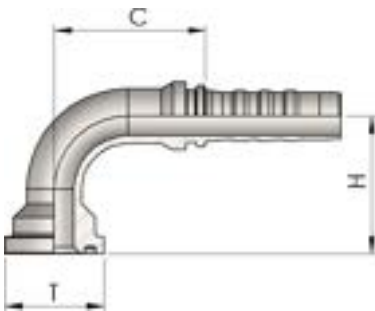

### 90° SAE Flange 6000 PSI

(SFS 90°)

Product number	hose I.D.		Dimension				
	in	mm	dash size	T Flange	mm	drop H	Cut-off C
1100N08-08	1/2	12.7	08	1/2	31,8	39	42
1100N10-12	5/8	15.9	10	3/4	41.3	51	46
1100N12-12	3/4	19	12	3/4	41.3	57	58
1100N12-16	3/4	19	12	1	47.6	63	56
1100N16-16	1	25.4	16	1	47.6	69	72
1100N16-20	1	25.4	16	1.1/4	54	77	72
1100N20-20	1.1/4	31.8	20	1.1/4	54	84.5	100
1100N20-24	1.1/4	31.8	20	1.1/2	63.5	92	101
1100N24-24	1.1/2	38.1	24	1.1/2	63.5	101	121.5



## 1200N

### 45° SAE Flange 6000 PSI

(SFS 45°)

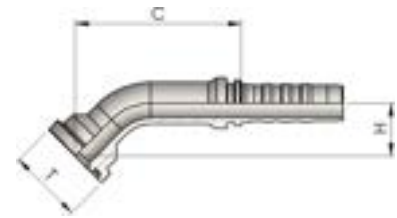

Product number	hose I.D.		Dimension				
	in	mm	dash size	T Flange	mm	drop H	Cut-off C
1200N08-08	1/2	12.7	08	1/2	31.8	22	62
1200N12-12	3/4	19	12	3/4	41.3	28	74
1200N12-16	3/4	19	12	1	47.6	32	90
1200N16-16	1	25.4	16	1	47.6	34	86
1200N16-20	1	25.4	16	1.1/4	54	39	90
1200N20-16	1.1/4	31.8	20	1	47.6	51	100
1200N20-20	1.1/4	31.8	20	1.1/4	54	41	111
1200N20-24	1.1/4	31.8	20	1.1/2	63.5	48	118
1200N24-20	1.1/2	38.1	24	1.1/4	54	40	154
1200N24-24	1.1/2	38.1	24	1.1/2	63.5	50	122
1200N24-32	1.1/2	38.1	24	2	79.4	59	128

## 130SN

### Straight 'CAT' Flange

(SFC)

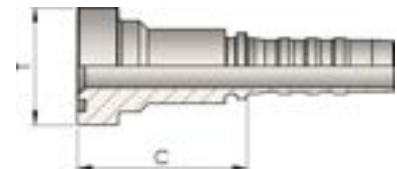

Product number	hose I.D.		I.D.	Dimension		
	in	mm		dash size	T Flange	mm
130SN12-12	3/4	19	12	3/4	41.3	60
130SN12-16	3/4	19	12	1	47.6	66
130SN16-16	1	25.4	16	1	47.6	67
130SN16-20	1	25.4	16	1.1/4	54	75
130SN20-20	1.1/4	31.8	20	1.1/4	54	77
130SN24-24	1.1/2	38.1	24	1.1/2	63.5	85

# 110SN

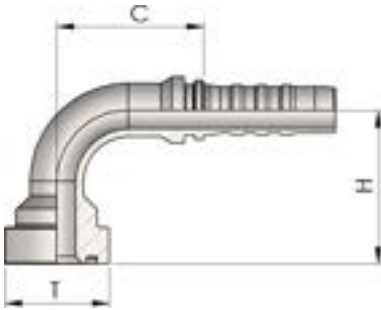

**90° 'CAT' Flange**

**(SFC 90°)**

Product number	hose I.D.		Dimension				
	in	mm	dash size	T Flange	mm	H	Cut-off C
110SN12-12	3/4	19	12	3/4	41.3	62	56
110SN12-16	3/4	19	12	1	47.6	65	56
110SN16-16	1	25.4	16	1	47.6	74	78
110SN16-20	1	25.4	16	1.1/4	54	80	78
110SN20-16	1.1/4	31.8	20	1	47.6	87	97
110SN20-20	1.1/4	31.8	20	1.1/4	54	90	97
110SN20-24	1.1/4	31.8	20	1.1/2	63.5	95	97
110SN24-20	1.1/2	38.1	24	1.1/4	54	101	115
110SN24-24	1.1/2	38.1	24	1.1/2	63.5	104	115
110SN24-32	1.1/2	38.1	24	2	79.4	114	115

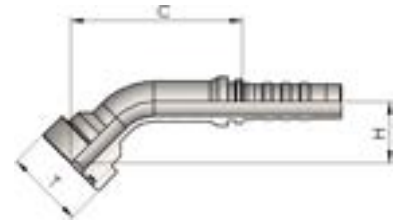
**120SN****45° 'CAT' Flange****(SFC 45°)**

Product number	hose I.D.		Dimension				
	in	mm	dash size	T Flange	mm	H	Cut-off C
120SN12-12	3/4	19	12	3/4	41.3	32	88
120SN12-16	3/4	19	12	1	47.6	37	93
120SN16-16	1	25.4	16	1	47.6	37	90
120SN16-20	1	25.4	16	1.1/4	54	44	122
120SN20-16	1.1/4	31.8	20	1	47.6	40	111
120SN20-20	1.1/4	31.8	20	1.1/4	54	43	114
120SN20-24	1.1/4	31.8	20	1.1/2	63.5	48	119
120SN24-20	1.1/2	38.1	24	1.1/4	54	50	170
120SN24-24	1.1/2	38.1	24	1.1/2	63.5	52	172

# Interlock Tail





**004N**



Swaged Ferrule (skive)

**116**

**0013**



Swaged Ferrule (skive)

**116**

**00J4**



Swaged Ferrule (skive)

**117**

**00J6**



Swaged Ferrule (skive)

**117**



**0370H**



NPTF Male 60° cone

**117**



**0350H**



BSP Male Parallel 60° cone

**118**

**0050H**



BSP Female 60° cone Thrust Wire

**118**

**0150H**



BSP 90° Swept Elbow 60° cone Thrust Wire

**119**



**0850H**



JIC Male 74° cone

**119**



**0900H**



JIC Female 74° - Thrust Wire Nut

**120**

**1000H**



JIC 45° Swept Elbow 74° Cone - Thrust Wire

**120**



**0450H**



Metric Male 24° Seat Heavy

**121**

**0084H**



Metric Female 24° Seat Heavy

**121**



**0184H**



90° Metric Swept Elbow 24° Seat Heavy

**122**

**0284H**



45° Metric Swept Elbow 24° Seat Heavy

**122**



**S350H**



ORFS Male

**123**

**S05TH**



ORFS Female Back Hexagon

**123**

**S150H**



ORFS 90° Swept Elbow

**124**

**S250H**



ORFS 45° Swept Elbow

**124**



**1250H**



Straight SAE Flange 3000 PSI

**125**

**1050H**



90° SAE Flange 3000 PSI

**125**

**1150H**



45° SAE Flange 3000 PSI

**126**

**1300H**



Straight SAE Flange 6000 PSI

**127**

**1100H**



90° SAE Flange 6000 PSI

**128**

**1200H**



45° SAE Flange 6000 PSI

**129**



**130SH**



Straight 'CAT' Flange

**129**

**110SH**



90° 'CAT' Flange

**130**

**120SH**



45° 'CAT' Flange

**130**



**D050H**



Hose Junction

**131**

## 004N

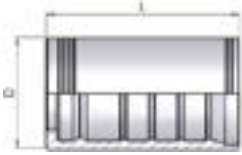

### Swaged Ferrule (skive)

Product number	hose I.D.		Dimension		skive	valid for
	in	mm	D	L	Length	
004N-12	3/4	19	38	60	52/15	R13-4SH-R15 -(4SP)
004N-16	1	25.4	46	75	64/17	4SH-R13-R15-(4SP)
004N-20	1.1/4	31.8	55	88	74/22	4SH
004N-24	1.1/2	38.1	62	94	81/22,5	4SH
004N-32	2	50.8	78	99	85/30	4SH

## 0013

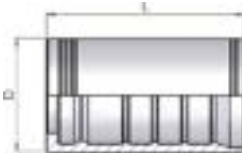

### Swaged Ferrule (skive)

Product number	hose I.D.		Dimension		skive	valid for
	in	D	mm	L	Length	
0013-10	5/8	35.5	15.9	57.5	47/15	R15
0013-16	1	48	25.4	75	64/17	R13-R15
0013-20	1.1/4	60	31.8	88	74/22	R13 -R15
0013-24	1.1/2	67	38.1	94	81/22,5	R13 -R15
0013-32	2	85	50.8	99	85/30	R13-R15



## 00J4

### Swaged Ferrule (skive)

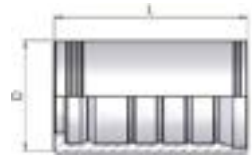

Product number	hose I.D.		Dimension		skive	valid for
	in	mm	D	L	Length	-
00J4-16	1	25.4	49	72.5	62/17	HySpir 500

## 00J6

### Swaged Ferrule (skive)

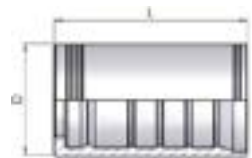

Product number	hose I.D.		Dimension		skive	valid for
	in	mm	D	L	Length	-
00J6-16	1	25.4	51	74.5	65/17	MegaJet

## 0370H

### NPTF Male 60° cone

(AGN)

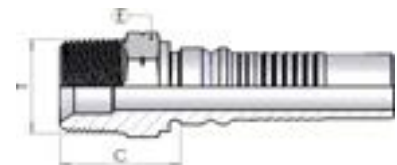

Product number	hose I.D.		Dimension			
	in	mm	dash size	Thread T	hex E	Cut-off C
0370H12-12	3/4	19	12	3/4-14	27	35
0370H16-16	1	25.4	16	1-11.1/2	36	41
0370H20-20	1.1/4	31.8	20	1.1/4-11.1/2	46	44
0370H24-24	1.1/2	38.1	24	1.1/2-11.1/2	50	47
0370H32-32	2	50.8	32	2-11.1/2	65	54

## 0350H

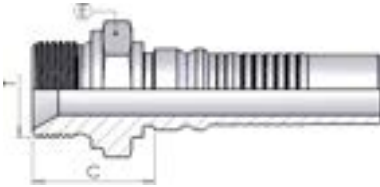

**BSP Male Parallel 60° cone**

**(AGR)**

Product number	hose I.D.		Dimension			
	in	mm	dash size	Thread T	hex E	Cut-off C
0350H12-12	3/4	19	12	3/4-14	32	33
0350H12-16	3/4	19	12	1-11	41	36
0350H16-16	1	25.4	16	1-11	41	37
0350H16-20	1	25.4	16	1.1/4-11	50	41
0350H20-20	1.1/4	31.8	20	1.1/4-11	50	42
0350H24-24	1.1/2	38.1	24	1.1/2-11	55	44
0350H32-32	2	50.8	32	2-11	70	53

## 0050H

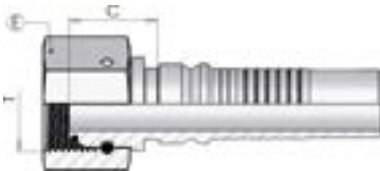

**BSP Female 60° cone Thrust Wire**

**(DKR)**

Product number	hose I.D.		Dimension			
	in	mm	dash size	Thread T	hex E	Cut-off C
0050H12-12	3/4	19	12	3/4-14	32	23
0050H12-16	3/4	19	12	1-11	41	25
0050H16-16	1	25.4	16	1-11	41	26
0050H20-20	1.1/4	31.8	20	1.1/4-11	50	29
0050H20-24	1.1/4	31.8	20	1.1/2-11	55	31
0050H24-24	1.1/2	38.1	24	1.1/2-11	55	31
0050H32-32	2	50.8	32	2-11	70	30

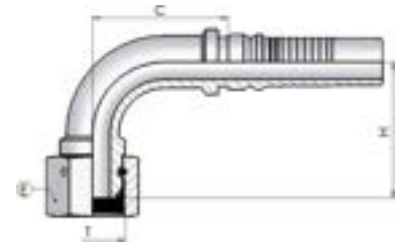
**0150H****BSP 90° Swept Elbow 60° cone  
Thrust Wire****(DKR 90°)**

Product number	hose I.D.		Dimension				
	in	dash size	mm	Thread T	hex E	drop H	Cut-off C
0150H12-12	3/4	12	19	3/4-14	32	60	51
0150H16-16	1	16	25.4	1-11	41	70	73
0150H16-20	1	16	25.4	1.1/4-11	50	76	73
0150H20-20	1.1/4	20	31.8	1.1/4-11	50	83	93
0150H24-24	1.1/2	24	38.1	1.1/2-11	55	104	111

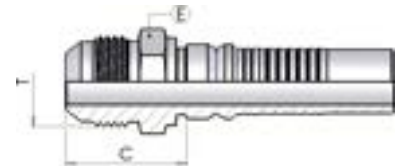
**0850H****JIC Male 74° cone****(AGJ)**

Product number	hose I.D.		Dimension			
	in	mm	dash size	Thread T	hex E	Cut-off C
0850H12-12	3/4	19	12	1.1/16-12	27	36
0850H16-16	1	25.4	16	1.5/16-12	34	40
0850H20-20	1.1/4	31.8	20	1.5/8-12	42	44
0850H24-24	1.1/2	38.1	24	1.7/8-12	50	49

## 0900H

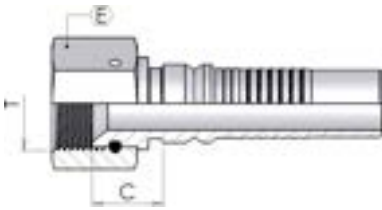

### JIC Female 74° - Thrust Wire Nut

**(DKJ)**

Product number	hose I.D.		Dimension			
	in	mm	dash size	Thread T	hex E	Cut-off C
0900H12-12	3/4	19	12	1.1/16-12	32	19
0900H12-16	3/4	19	12	1.5/16-12	41	22
0900H16-16	1	25.4	16	1.5/16-12	41	23
0900H20-20	1.1/4	31.8	20	1.5/8-12	50	26
0900H24-24	1.1/2	38.1	24	1.7/8-12	55	29
0900H32-32	2	50.8	32	2.1/2-12	70	30

## 1000H

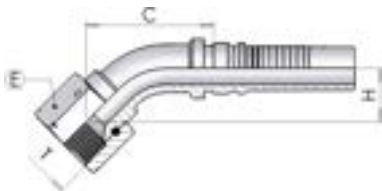

### JIC 45° Swept Elbow 74° Cone - Thrust Wire

**(DKJ 45°)**

Product number	hose I.D.		Dimension				
	in	dash size	mm	Thread T	hex E	drop H	Cut-off C
1000H12-12	3/4	12	19	1.1/16-12	32	28	85
1000H12-16	3/4	12	19	1.5/16-12	41	32	88
1000H16-16	1	16	25.4	1.5/16-12	41	33	83
1000H20-20	1.1/4	20	31.8	1.5/8-12	50	40	109
1000H24-24	1.1/2	24	38.1	1.7/8-12	55	49	165

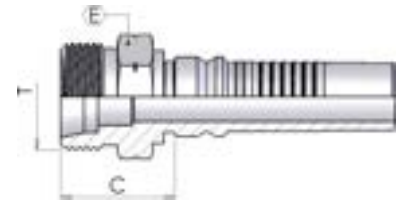
**0450H****Metric Male 24° Seat Heavy****(CES)**

Product number	hose I.D.		Dimension				
	in	mm	dash size	Thread T	erm.	hex E	Cut-off C
0450H12-36	3/4	19	12	M36-2	25	36	36
0450H16-42	1	25.4	16	M42-2	30	46	39
0450H20-52	1.1/4	31.8	20	M52-2	38	55	42
0450H24-52	1.1/2	38.1	24	M52-2	38	55	42.5

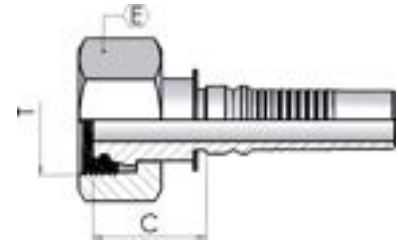
**0084H****Metric Female 24° Seat Heavy****(DKOS)**

Product number	hose I.D.		Dimension				
	in	mm	dash size	Thread T	erm.	hex E	Cut-off C
0084H12-36	3/4	19	12	M36-2	25	46	37
0084H16-36	1	25.4	16	M36-2	25	46	38
0084H16-42	1	25.4	16	M42-2	30	50	41
0084H20-42	1.1/4	31.8	20	M42-2	30	50	32
0084H20-52	1.1/4	31.8	20	M52-2	38	60	41
0084H24-52	1.1/2	38.1	24	M52-2	38	60	42

## 0184H

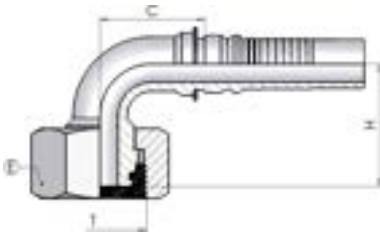

### 90° Metric Swept Elbow 24° Seat Heavy

(DKOS 90°)

Product number	hose I.D.		Dimension					
	in	dash size	mm	Thread T	erm.	hex E	drop H	Cut-off C
0184H12-36	3/4	12	19	M36-2	25	46	58	55
0184H16-36	1	16	25.4	M36-2	25	46	68	75
0184H16-42	1	16	25.4	M42-2	30	50	69	74
0184H20-52	1.1/4	20	31.8	M52-2	38	60	83	94

## 0284H

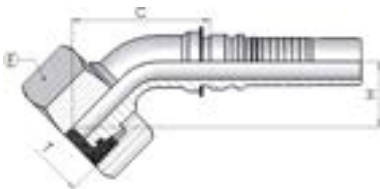

### 45° Metric Swept Elbow 24° Seat Heavy

(DKOS 45°)

Product number	hose I.D.		Dimension					
	in	dash size	mm	Thread T	erm.	hex E	drop H	Cut-off C
0284H12-36	3/4	12	19	M36-2	25	46	31	86
0284H16-36	1	16	25.4	M36-2	25	46	34	82
0284H16-42	1	16	25.4	M42-2	30	50	33	84
0284H20-52	1.1/4	20	31.8	M52-2	38	60	40	105

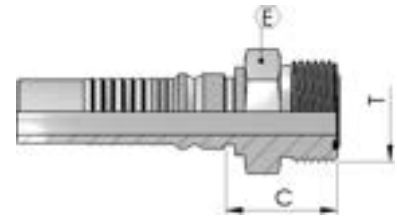
**S350H****ORFS Male****(ORFS)**

Product number	hose I.D.		Dimension			
	in	mm	dash size	Thread T	hex E	Cut-off C
S350H12-14-BO	3/4	19	12	1.3/16-12	32	34
S350H16-15-BO	1	25.4	16	1.7/16-12	38	35
S350H20-21-BO	1.1/4	31.8	20	1.11/16-12	46	36
S350H24-32-BO	1.1/2	38.1	24	2-12	55	38

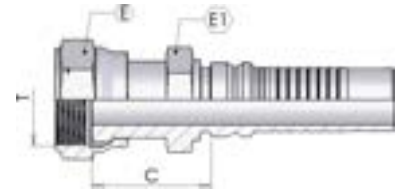
**S05TH****ORFS Female Back Hexagon****(ORFS)**

Product number	hose I.D.		Dimension				
	in	mm	dash size	Thread T	hex E	E1	Cut-off C
S05TH12-14	3/4	19	12	1.3/16-12	36	30	39
S05TH16-15	1	25.4	16	1.7/16-12	41	36	47
S05TH20-21	1.1/4	31.8	20	1.11/16-12	50	46	50

## S150H

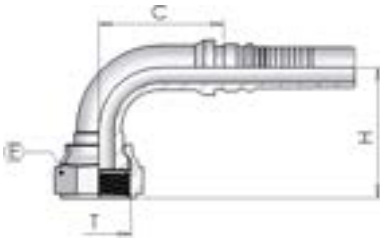

### ORFS 90° Swept Elbow

**(ORFS 90°)**

Product number	hose I.D.		Dimension				
	in	mm	dash size	Thread T	hex E	drop H	Cut-off C
S150H12-14	3/4	19	12	1.3/16-12	36	54	50
S150H16-15	1	25.4	16	1.7/16-12	41	66	69
S150H20-21	1.1/4	31.8	20	1.11/16-12	50	80	87

## S250H

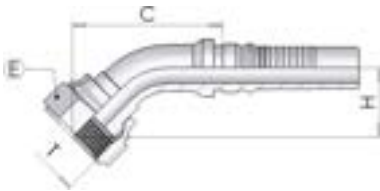

### ORFS 45° Swept Elbow

**(ORFS 45°)**

Product number	hose I.D.		Dimension				
	in	mm	dash size	Thread T	hex E	drop H	Cut-off C
S250H12-14	3/4	19	12	1.3/16-12	36	23	84
S250H16-15	1	25.4	16	1.7/16-12	41	28	77
S250H20-21	1.1/4	31.8	20	1.11/16-12	50	37	130

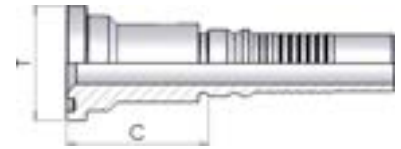

**1250H****Straight SAE Flange 3000 PSI****(SFL)**

Product number	hose I.D.		Dimension			
	in	mm	dash size	T Flange	mm	Cut-off C
1250H12-12	3/4	19	12	3/4	38.1	47
1250H12-16	3/4	19	12	1	44.5	50
1250H16-16	1	25.4	16	1	44.5	52
1250H20-20	1.1/4	31.8	20	1.1/4	50.8	56
1250H20-24	1.1/4	31.8	20	1.1/2	60.3	59
1250H24-24	1.1/2	38.1	24	1.1/2	60.3	60
1250H32-32	2	50.8	32	2	71.4	67

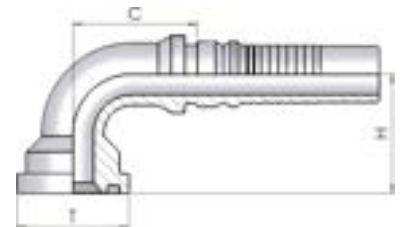
**1050H****90° SAE Flange 3000 PSI****(SFL 90°)**

Product number	hose I.D.		Dimension				
	in	dash size	mm	T Flange	mm	drop H	Cut-off C
1050H12-12	3/4	12	19	3/4	38.1	52	52
1050H12-16	3/4	12	19	1	44.5	56	55
1050H16-16	1	16	25.4	1	44.5	65	73
1050H20-20	1.1/4	20	31.8	1.1/4	50.8	82	91
1050H24-24	1.1/2	24	38.1	1.1/2	60.3	94	109
1050H32-32	2	32	50.8	2	71.4	113	128

# 1150H

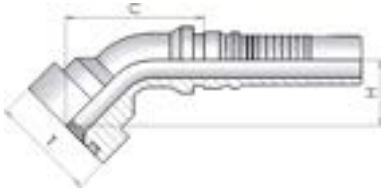

**45° SAE Flange 3000 PSI**

**(SFL 45°)**

Product number	hose I.D.		Dimension				
	in	mm	dash size	T Flange	mm	drop H	Cut-off C
1150H12-12	3/4	19	12	3/4	38.1	25	81
1150H12-16	3/4	19	12	1	44.5	28	86
1150H16-16	1	25.4	16	1	44.5	35	107
1150H16-20	1	25.4	16	1.1/4	50.8	37	113
1150H20-20	1.1/4	31.8	20	1.1/4	50.8	37	113
1150H20-24	1.1/4	31.8	20	1.1/2	60.3	40	113
1150H24-24	1.1/2	38.1	24	1.1/2	60.3	44	125
1150H24-32	1.1/2	38.1	24	2	71.4	40	126
1150H32-32	2	50.8	32	2	71.4	50	133

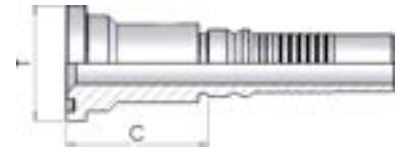
**1300H****Straight SAE Flange 6000 PSI****(SFS)**

Product number	hose I.D.		Dimension			
	in	mm	dash size	T Flange	mm	Cut-off C
1300H12-12	3/4	19	12	3/4	41.3	51
1300H12-16	3/4	19	12	1	47.6	57
1300H16-12	1	25.4	16	3/4	41.3	52
1300H16-16	1	25.4	16	1	47.6	59
1300H16-20	1	25.4	16	1.1/4	54	66
1300H20-16	1.1/4	31.8	20	1	47.6	60
1300H20-20	1.1/4	31.8	20	1.1/4	54	67
1300H20-24	1.1/4	31.8	20	1.1/2	63.5	73
1300H24-20	1.1/2	38.1	24	1.1/4	54	75
1300H24-24	1.1/2	38.1	24	1.1/2	63.5	74
1300H24-32	1.1/2	38.1	24	2	79.4	82
1300H32-32	2	50.8	32	2	79.4	84

# 1100H

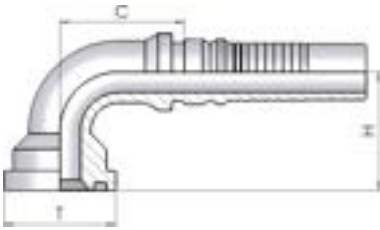

**90° SAE Flange 6000 PSI**

**(SFS 90°)**

Product number	hose I.D.		Dimension				
	in	mm	dash size	T Flange	mm	drop H	Cut-off C
1100H12-12	3/4	19	12	3/4	41.3	55	53
1100H12-16	3/4	19	12	1	47.6	63	52
1100H16-12	1	25.4	16	3/4	41.3	66	73
1100H16-16	1	25.4	16	1	47.6	69	75
1100H16-20	1	25.4	16	1.1/4	54	74	71
1100H20-16	1.1/4	31.8	20	1	47.6	80	93
1100H20-20	1.1/4	31.8	20	1.1/4	54	84,5	93
1100H20-24	1.1/4	31.8	20	1.1/2	63.5	92	94
1100H24-24	1.1/2	38.1	24	1.1/2	63.5	101	114
1100H24-32	1.1/2	38.1	24	2	79.4	115	115
1100H32-32	2	50.8	32	2	79.4	126	136.5

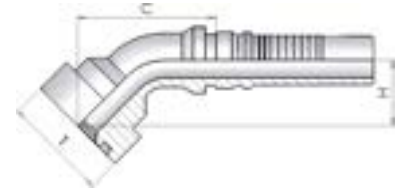
**1200H****45° SAE Flange 6000 PSI****(SFS 45°)**

Product number	hose I.D.		Dimension				
	in	mm	dash size	T Flange	mm	drop H	Cut-off C
1200H12-12	3/4	19	12	3/4	41.3	28	85
1200H12-16	3/4	19	12	1	47.6	34	88
1200H16-12	1	25.4	16	3/4	41.3	31	79
1200H16-16	1	25.4	16	1	47.6	34	85
1200H16-20	1	25.4	16	1.1/4	54	40	89
1200H20-16	1.1/4	31.8	20	1	47.6	34	93
1200H20-20	1.1/4	31.8	20	1.1/4	54	41	109
1200H24-24	1.1/2	38.1	24	1.1/2	63.5	50	133
1200H32-32	2	50.8	32	2	79.4	58	151

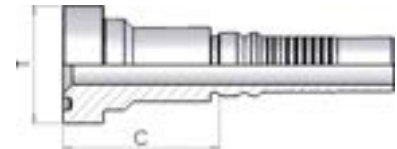
**130SH****Straight 'CAT' Flange****(SFC)**

Product number	hose I.D.		Dimension			
	in	mm	dash size	T Flange	mm	Cut-off C
130SH12-12	3/4	19	12	3/4	41.3	55
130SH12-16	3/4	19	12	1	47.6	62
130SH16-16	1	25.4	16	1	47.6	63
130SH16-20	1	25.4	16	1.1/4	54	70
130SH20-20	1.1/4	31.8	20	1.1/4	54	71
130SH24-24	1.1/2	38.1	24	1.1/2	64	78

## 110SH

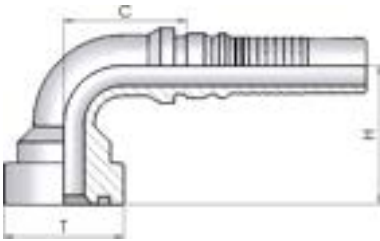

**90° 'CAT' Flange**

**(SFC 90°)**

Product number	hose I.D.		Dimension				
	in	mm	dash size	T Flange	mm	drop H	Cut-off C
110SH12-12	3/4	19	12	3/4	41.3	62	51
110SH16-16	1	25.4	16	1	47.6	75	73.2
110SH16-20	1	25.4	16	1.1/4	54	82	74
110SH20-20	1.1/4	31.8	20	1.1/4	54	89	93
110SH24-24	1.1/2	38.1	24	1.1/2	63.5	106	110

## 120SH

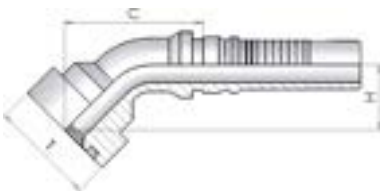

**45° 'CAT' Flange**

**(SFC 45°)**

Product number	hose I.D.		Dimension				
	in	mm	dash size	T Flange	mm	drop H	Cut-off C
120SH12-12	3/4	19	12	3/4	41.3	30	89
120SH16-16	1	25.4	16	1	47.6	38	115
120SH24-24	1.1/2	38.1	24	1.1/2	63.5	52	169

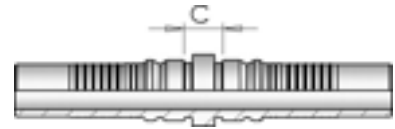
**D050H****Hose Junction**

Product number	hose I.D.		I.D.		Dimension	
	in	mm	dash size	Cut-off C		
D050H12	3/4	19	12	15		
D050H16	1	25.4	16	16		
D050H20	1.1/4	31.8	20	19		
D050H24	1.1/2	38.1	24	19		
D050H32	2	50.8	32	24		

# Hyblast / Multispiral Tail







**00Y4**



Swaged Ferrule (skive)

**135**

**00Y6**



Swaged Ferrule (skive)

**135**

**0019**



Swaged Ferrule (skive)

**135**



**0050Y**



BSP Female 60° cone Thrust Wire

**136**



**0370Y**



NPTF Male 60° cone

**136**



**0084Y**



Metric Female 24° Seat Heavy

**137**



**002M**



Swaged Ferrule (skive)

**137**



**0900M**



JIC Female 74° - Thrust Wire Nut

**138**

**0950M**



JIC 90° Swept Elbow 74° Cone - Thrust Wire

**138**



**0050M**



BSP Female 60° cone Thrust Wire

**138**

**0150M**



BSP 90° Swept Elbow 60° cone Thrust Wire

**139**



**0370M**



NPTF Male 60° cone

**139**



**0084M**



Metric Female 24° Seat Heavy

**139**

**0184M**



90° Metric Swept Elbow 24° Seat Heavy

**140**

## 00Y4

### Swaged Ferrule (skive)



Product number	hose I.D.		I.D.		Dimension		valid for
	in		mm		D	L	
00Y4-06	3/8		9.5		32.5	58.5	HB18k
00Y4-08	1/2		12.7		36.5	62	HB18k
00Y4-12	3/4		19		43.8	69	HB15k

## 00Y6

### Swaged Ferrule (skive)

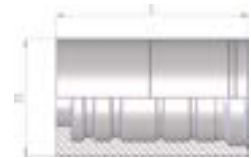

Product number	hose I.D.		I.D.		Dimension	
	in		mm		D	L
00Y6-06	3/8		9.5		35.5	58.5
00Y6-08	1/2		12.7		39.8	62
00Y6-12	3/4		19		47	69

## 0019

### Swaged Ferrule (skive)

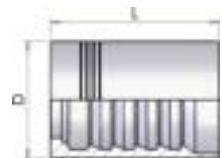

Product number	hose I.D.		Dimension		skive	valid for
	in	D	mm	L	Length	
0019-04	1/4	21	6.4	40	30	WB-VHP-4SP-4SH

## 0050Y

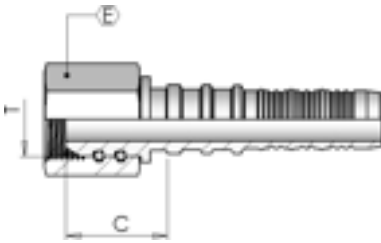

### BSP Female 60° cone Thrust Wire

Product number	hose I.D.		Dimension			
	in	mm	dash size	Thread T	hex E	Cut-off C
0050Y08-08	1/2	12.7	08	1/2-14	30	33
0050Y16-16	1	25.4	16	1-11	38	40

## 0370Y

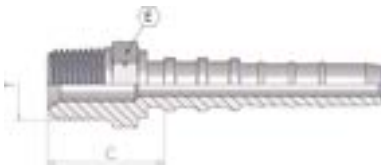

### NPTF Male 60° cone

**(AGN)**

Product number	hose I.D.		I.D.	Dimension		
	in	mm		dash size	Cut-off C	T
0370Y06-06	3/8	9.5	06	29	3/8-18	19
0370Y08-08	1/2	12.7	08	35	1/2-14	22
0370Y12-12	3/4	19	12	37	3/4-14	27
0370Y16-16	1	25.4	16	49	1-11.1/2	38

## 0084Y

### Metric Female 24° Seat Heavy

(DKOS)

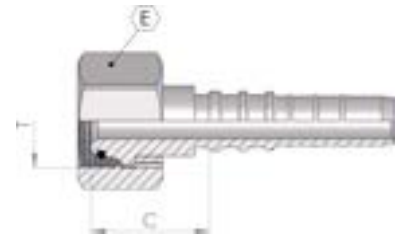

Product number	hose I.D.		Dimension				
	in	mm	dash size	T	erm.	E	Cut-off C
0084Y06-22	3/8	9.5	06	M22-1.5	14	30	38
0084Y06-24	3/8	9.5	06	M24-1.5	16	32	39
0084Y08-24	1/2	12.7	08	M24-1.5	16	34	39
0084Y12-36	3/4	19	12	M36-2	25	46	45

## 002M

### Swaged Ferrule (skive)

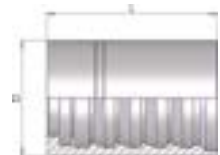

Product number	hose I.D.	Dimension		I.D.	skive
	in	D	mm	L	Length
002M-04	1/4	19.6	6.4	38	29
002M-06	3/8	24	9.5	40	31

## 0900M

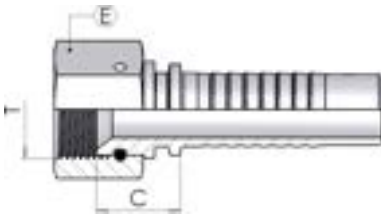

### JIC Female 74° - Thrust Wire Nut

(DKJ)

Product number	hose I.D.		Dimension			
	in	mm	dash size	Thread T	hex E	Cut-off C
0900M04-04	1/4	6.4	04	7/16-20	17	16
0900M06-06	3/8	9.5	06	9/16-18	19	18
0900M06-08	3/8	9.5	06	3/4-16	24	20

## 0950M

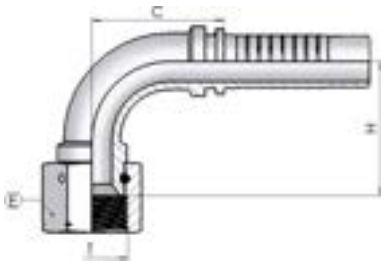

### JIC 90° Swept Elbow 74° Cone - Thrust Wire

(DKJ 90°)

Product number	hose I.D.		Dimension				
	in	mm	dash size	Thread T	hex E	drop H	Cut-off C
0950M04-04	1/4	6.4	04	7/16-20	17	26	26
0950M06-06	3/8	9.5	06	9/16-18	19	33	35
0950M06-08	3/8	9.5	06	3/4-16	24	34	35

## 0050M

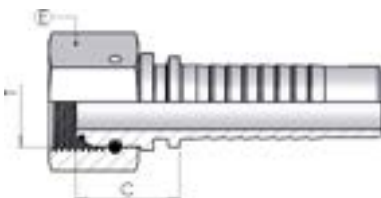

### BSP Female 60° cone Thrust Wire

(DKR)

Product number	hose I.D.		Dimension			
	in	mm	dash size	Thread T	hex E	Cut-off C
0050M04-04	1/4	6.4	04	1/4-19	19	20

## 0150M

**BSP 90° Swept Elbow 60° cone  
Thrust Wire**

**(DKR 90°)**

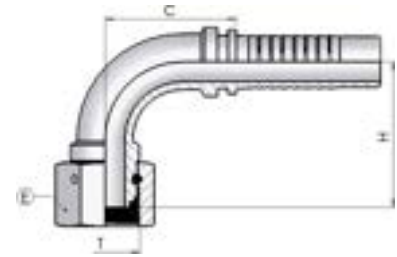

Product number	hose I.D.		Dimension				
	in	mm	dash size	Thread T	hex E	drop H	Cut-off C
0150M04-04	1/4	6.4	04	1/4-19	19	28	26

## 0370M

**NPTF Male 60° cone**

**(AGN)**

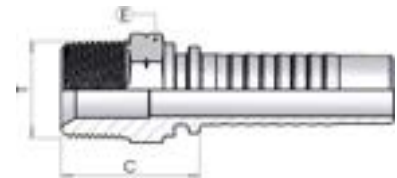

Product number	hose I.D.		Dimension			
	in	mm	dash size	Thread T	hex E	Cut-off C
0370M04-04	1/4	6.4	04	1/4-18	15	29
0370M06-06	3/8	9.5	06	3/8-18	19	29

## 0084M

**Metric Female 24° Seat Heavy**

**(DKOS)**

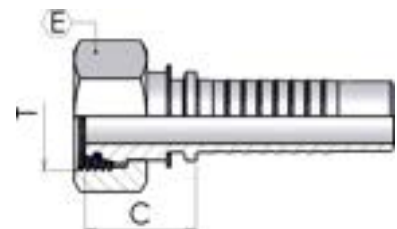

Product number	hose I.D.		Dimension				
	in	mm	dash size	Thread T	erm.	hex E	Cut-off C
0084M04-16	1/4	6.4	04	M16-1.5	8	19	27
0084M04-18	1/4	6.5	04	M18-1.5	10	22	24

# 0184M

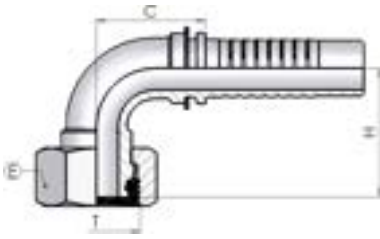

## 90° Metric Swept Elbow 24° Seat Heavy

**(DKOS 90°)**

Product number	hose I.D.		Dimension					
	in	dash size	mm	Thread T	erm.	hex E	drop H	Cut-off C
0184M04-16	1/4	04	6.4	M16-1.5	8	19	26	28
0184M04-18	1/4	04	6.4	M18-1.5	10	22	31	33



# Low Pressure Fittings





**P050**



BSP Female 60° cone - UniLock

**143**

**P150**



BSP 90° Swept elbow 60° cone - UniLock

**143**



**BA**



Steel ferrule

**144**



**0345B**



BSP Male - Flat Seat

**145**

**0350B**



BSP Male Parallel 60° cone

**146**



**0051B**



BSP Female 60° Cone

**147**

**0151B**



BSP 90° Swept Elbow 60° Cone

**148**

**0251B**



BSP 45° Swept Elbow 60° Cone

**149**



**1350B**



Metric Banjo

**150**

## P050

### BSP Female 60° cone - UniLock

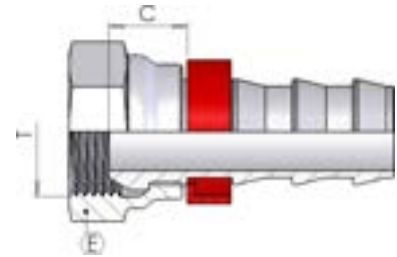

Product number	hose I.D.		Dimension			
	in	mm	dash size	Thread T	hex E	Cut-off C
P050-04-04	1/4	6.4	04	1/4-19	17	10
P050-06-06	3/8	9.5	06	3/8-19	19	10
P050-08-08	1/2	12.7	08	1/2-14	27	13
P050-12-12	3/4	19	12	3/4-14	32	16
P050-16-16	1	25.4	16	1-11	38	15

## P150

### BSP 90° Swept elbow 60° cone - UniLock

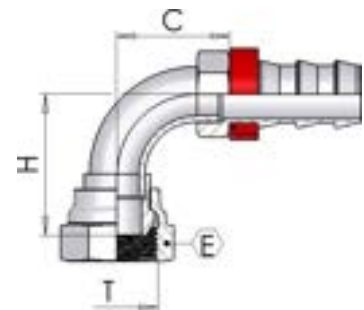

Product number	hose I.D.		Dimension				
	in	mm	dash size	Thread T	hex E	drop H	Cut-off C
P150-04-04	1/4	6.4	04	1/4-19	17	23	21
P150-06-06	3/8	9.5	06	3/8-19	19	29	31
P150-08-08	1/2	12.7	08	1/2-14	27	36	38
P150-12-12	3/4	19	12	3/4-14	32	65	54
P150-16-16	1	25.4	16	1-11	38	55	44

## BA

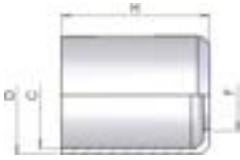

## Steel ferrule

Product number	Dimension			
	D	C	F	H
BA-021-024	24	21	16	31
BA-024-027	27	24	18	31
BA-027-030	30	27	20	34
BA-029-032	32	29	21	35
BA-035-038	38	35	27	36
BA-037-040	40	37	28	38
BA-039-042	42	39	29	40
BA-046-050	50	46	34	46
BA-085-090	90	85	68	63
BA-095-100	100	95	78	68

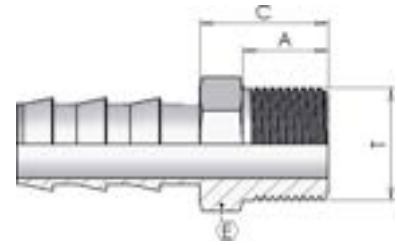
**0345B****BSP Male - Flat Seat**

Product number	hose I.D.		Dimensions		Dimension		
	in	mm	DN	Thread T	Cut-off C	A	hex E
0345B04-02	1/4	6.4	06	1/8	16	10	14
0345B04-04	1/4	6.4	06	1/4	16	10	14
0345B05-04	5/16	7.9	08	1/4	16	10	14
0345B05-06	5/16	7.9	08	3/8	19	12	17
0345B06-04	3/8	9.5	10	1/4	16	10	17
0345B06-06	3/8	9.5	10	3/8	19	12	17
0345B06-08	3/8	9.5	10	1/2	21	13	22
0345B08-06	1/2	12.7	13	3/8	19	12	19
0345B08-08	1/2	12.7	13	1/2	21	13	22
0345B10-06	5/8	15.9	16	3/8	19	12	19
0345B10-08	5/8	15.9	16	1/2	21	13	22
0345B10-12	5/8	15.9	16	3/4	21	15	27
0345B12-08	3/4	19	19	1/2	21	13	24
0345B12-12	3/4	19	19	3/4	23	15	27
0345B12-16	3/4	19	19	1	25	16	34
0345B16-12	1	25.4	25	3/4	23	15	30
0345B16-16	1	25.4	25	1	25	16	34
0345B20-12	1.1/4	31.8	32	3/4	23	15	34
0345B20-16	1.1/4	31.8	32	1	26	16	36
0345B20-20	1.1/4	31.8	32	1.1/4	27	17	42
0345B24-20	1.1/2	38.1	38	1.1/4	27	17	42
0345B24-24	1.1/2	38.1	38	1.1/2	29	18	50
0345B32-32	2	50.8	50	2	31	19	60
0345B40-40	2.1/2	63.5	70	2.1/2	36	23	75

# 0350B

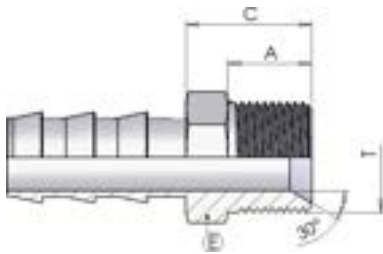

## BSP Male Parallel 60° cone

Product number	hose I.D.		Dimensions		Dimension		
	in	mm	DN	Thread T	Cut-off C	A	hex E
0350B04-02	1/4	6.4	06	1/8	14	9	14
0350B04-04	1/4	6.4	06	1/4	16	10	19
0350B05-04	5/16	7.9	08	1/4	16	10	19
0350B06-04	3/8	9.5	10	1/4	16	10	19
0350B06-06	3/8	9.5	10	3/8	18	12	22

## 0051B

## BSP Female 60° Cone

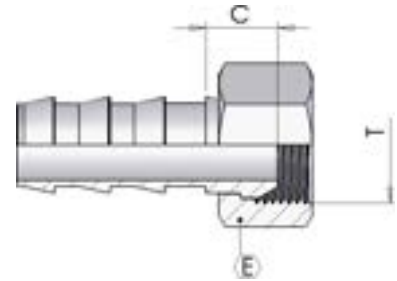

Product number	hose I.D.		Dimensions DN	Dimension		
	in	mm		Thread T	Cut-off C	hex E
0051B03-02	3/16	4.8	05	1/8	9	14
0051B04-02	1/4	6.4	06	1/8	9	14
0051B04-04	1/4	6.4	06	1/4	10	17
0051B05-04	5/16	7.9	08	1/4	10	17
0051B05-06	5/16	7.9	08	3/8	11	19
0051B06-06	3/8	9.5	10	3/8	11	19
0051B06-08	3/8	9.5	10	1/2	12	24
0051B08-06	1/2	12.7	13	3/8	11	19
0051B08-08	1/2	12.7	13	1/2	12	24
0051B10-08	5/8	15.9	16	1/2	12	24
0051B10-12	5/8	15.9	16	3/4	14	30
0051B12-12	3/4	19	19	3/4	14	30
0051B12-16	3/4	19	19	1	15	38
0051B16-16	1	25.4	25	1	16	38
0051B20-20	1.1/4	31.8	32	1.1/4	16	46
0051B20-24	1.1/4	31.8	32	1.1/2	18	55
0051B24-24	1.1/2	38.1	38	1.1/2	18	55
0051B32-32	2	50.8	50	2	19	65
0051B40-40	2.1/2	63.5	60	2.1/2	24	85
0051B48-48	3	76.2	70	3	26	100

## 0151B

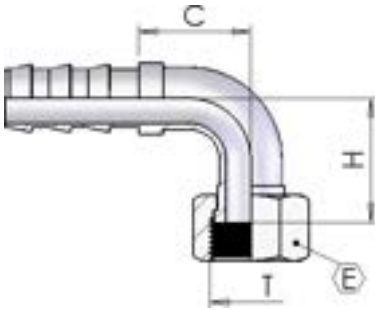

### BSP 90° Swept Elbow 60° Cone

Product number	hose I.D.		Dimensions DN	Dimension			
	in	mm		Thread T	Cut-off C	drop H	hex E
0151B04-04	1/4	6.4	06	1/4	28	25	17
0151B05-04	5/16	7.9	08	1/4	28	25	17
0151B05-06	5/16	7.9	08	3/8	32	32	19
0151B06-06	3/8	9.5	10	3/8	33	33	19
0151B06-08	3/8	9.5	10	1/2	38	35	24
0151B08-06	1/2	12.7	13	3/8	38	35	19
0151B08-08	1/2	12.7	13	1/2	43	41	24
0151B08-12	1/2	12.7	13	3/4	40	45	30
0151B10-08	5/8	15.9	16	1/2	44	41	24
0151B10-12	5/8	15.9	16	3/4	40	45	30
0151B12-12	3/4	19	19	3/4	51	49	30
0151B12-16	3/4	19	19	1	45	49	38
0151B16-12	1	25.4	25	3/4	45	57	32
0151B16-16	1	25.4	25	1	60	58	38
0151B16-20	1	25.4	25	1.1/4	56	64	46
0151B20-20	1.1/4	31.8	32	1.1/4	70	66	46
0151B24-24	1.1/2	38.1	38	1.1/2	70	75	55
0151B32-32	2	50.8	50	2	66	70	65
0151B40-40	2.1/2	63.5	60	2.1/2	82	85	85

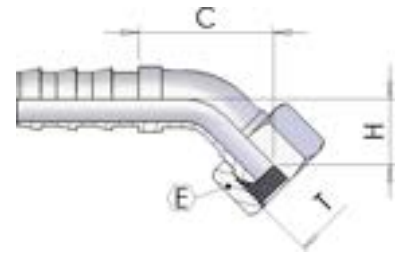

**0251B****BSP 45° Swept Elbow 60° Cone**

Product number	hose I.D.		Dimensions DN	Dimension			
	in	mm		Thread T	Cut-off C	drop H	hex E
0251B04-04	1/4	6.4	06	1/4	44	17	17
0251B05-06	5/16	7.9	08	3/8	50	19	19
0251B06-06	3/8	9.5	10	3/8	52	20	19
0251B06-08	3/8	9.5	10	1/2	54	23	24
0251B08-06	1/2	12.7	13	3/8	54	23	19
0251B08-08	1/2	12.7	13	1/2	60	25	24
0251B10-12	5/8	15.9	16	3/4	65	28	30
0251B12-12	3/4	19	19	3/4	65	28	30
0251B12-16	3/4	19	19	1	55	30	38
0251B16-16	1	25.4	25	1	74	30	38
0251B20-20	1.1/4	31.8	32	1.1/4	72	35	46
0251B24-24	1.1/2	38.1	38	1.1/2	72	35	55
0251B32-32	2	50.8	50	2	90	50	65

# 1350B

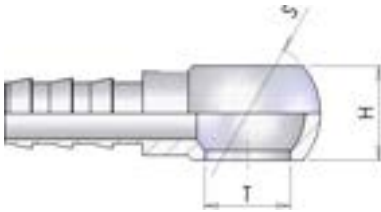

## Metric Banjo

Product number	hose I.D.		Dimensions DN	Dimension		
	in	mm		hole T	H	S
1350B04-10	1/4	6.4	06	M10-1	11	17
1350B04-12	1/4	6.4	06	M12-1,5	12	20
1350B04-14	1/4	6.4	06	M14-1,5	14	24
1350B05-12	5/16	7.9	08	M12-1,5	12	20
1350B05-14	5/16	7.9	08	M14-1,5	14	24
1350B05-16	5/16	7.9	08	M16-1,5	19	28
1350B06-16	3/8	9.5	10	M16-1,5	19	28
1350B06-18	3/8	9.5	10	M18-1,5	20	32
1350B08-18	1/2	12.7	13	M18-1,5	20	32
1350B08-22	1/2	12.7	13	M22-1,5	23	36
1350B10-18	5/8	15.9	16	M18-1,5	20	32

## Indice Analitico

001C	11	0550	51
0022	12	0650	52
012N	13	0650S	52
0001	14	0750	53
0002	15	0750S	53
0009	16	0035	54
004H	16	0135	55
OSI4	17	0400	56
BMC1	17	0100	57
BMC2	18	0200	58
0007	18	S350	59
0008	19	S050	60
0003	19	S05T	61
PTFE	20	S150	62
PTFE-C	20	S15S	63
0345	21	S250	64
0060	22	1260	65
0350	23	1060	66
035G	24	1160	67
0050	25	FS3L	67
0051	25	S003	68
0058	25	1310	69
0051D	26	1110	70
0150	27	1210	71
0151	27	FS6L	71
0158	27	S006	72
0250	28	130S	72
0251	28	110S	73
0258	28	120S	73
2321	29	1250	74
2300	29	1050	74
0041	30	1150	74
0048	30	0940	75
0141	31	0990S	76
0148	31	0930	76
0241	32	0980S	77
0248	32	0920	77
0360	33	0030	78
0370	34	FK50	78
037G	35	FN50	79
N051	35	FN51	79
0850	36	1400	80
0900	37	1600	81
0901	37	1600-00	81
0902	37	1350	82
0901D	38	1650	83
0950	39	D050	84
0951	39	G500	85
0952	39	ONI4	90
1000	40	ONI6	90
1001	40	0370N	91
1002	40	0350N	91
095S	41	0050N 0051N	92
2971	41	0150N 0151N	93
0385	42	0250N 0251N	94
0500	43	0500N	95
0085	44	0085N	96
0185	45	0185N	96
0285	46	0285N	97
0450	47	0450N	97
0084	48	0084N	98
0184	49	0184N	98
0284	50	0284N	99

## Indice Analitico

0850N	100	P150	143
0900N 0901N	101	BA	144
0950N 0951N	102	0345B	145
0955N	102	0350B	146
1000N 1001N	103	0051B	147
S350N	104	0151B	148
S05TN	104	0251B	149
S150N	105	1350B	150
S155N	105		
S250N	106		
1250N	106		
1050N	107		
1150N	107		
1300N	108		
1100N	108		
1200N	109		
1305N	109		
1105N	110		
1205N	111		
004N	116		
0013	116		
00J4	117		
00J6	117		
0370H	117		
0350H	118		
0050H	118		
0150H	119		
0850H	119		
0900H	120		
1000H	120		
0450H	121		
0084H	121		
0184H	122		
0284H	122		
S350H	123		
S05TH	123		
S150H	124		
S250H	124		
1250H	125		
1050H	125		
1150H	126		
1300H	127		
1100H	128		
1200H	129		
1305H	129		
1105H	130		
1205H	130		
D050H	131		
00Y4	135		
00Y6	135		
0019	135		
0050Y	136		
0370Y	136		
0084Y	137		
002M	137		
0900M	138		
0950M	138		
0050M	138		
0150M	139		
0370M	139		
0084M	139		
0184M	140		
P050	143		

## Indice Sezioni

### Inserto Standard

Boccola a Pressare (non skive)	11	Curva Metrica 45° cono 24° Serie Pesante	50
Boccola a Pressare (non skive)	12	Femmina Metrica Tubolare Diritta	51
Boccola a Pressare	13	Femmina Metrica Tubolare 90°	52
Boccola a Pressare (skive)	14	Femmina Metrica Tubolare 90° (saldato)	52
Boccola a Pressare (skive)	15	Femmina Metrica Tubolare 45°	53
Boccola a Pressare (skive)	16	Femmina Metrica Tubolare 45° (saldato)	53
Boccola a Pressare (skive)	16	Femmina Metrica Cono 24° Serie Leggera Multiseal	54
Boccola a Pressare (non skive)	17	Curva Metrica 90° Cono 24° Serie Leggera Multiseal	55
Boccola a Pressare (non skive)	17	Maschio Metrico Svas.60°	56
Boccola a Pressare (non skive)	18	Femmina Metrica Cono 60°	57
Boccola a Pressare (non skive)	18	Curva Metrica 90° cono 60°	58
Boccola a Pressare (non skive)	18	Maschio ORFS	59
Boccola a Pressare (non skive)	19	Femmina ORFS	60
Boccola a Pressare (non skive)	19	Femmina ORFS doppio esagono	61
Boccola per tubo PTFE	20	Curva ORFS 90°	62
Boccola per tubo PTFE	20	Curva ORFS 90° - ISO SHORT	63
Maschio BSP - Sede Piana	21	Curva ORFS 45°	64
Femmina BSP Sede Piana	22	Flangia Diritta SAE 3000 PSI	65
Maschio BSP svas. 60°	23	Flangia 90° SAE 3000 PSI	66
Maschio BSP Svas.60° - girevole	24	Flangia 45° SAE 3000 PSI	67
Femmina BSP cono 60°	25	Flangia 90° SAE 3000 PSI - Tipo Lungo	67
Femmina BSP cono 60° Dado Rullato	25	Semiflange tagliate - 3000 psi	68
Femmina BSP cono 60° Dado Libero	25	Flangia Diritta SAE 6000 PSI	69
Femmina BSP cono 60° Doppio esagono	26	Flangia 90° SAE 6000 PSI	70
Curva BSP 90° cono 60°	27	Flangia 45° SAE 6000 PSI	71
Curva BSP 90° cono 60° Dado Rullato	27	Flangia 90° SAE 6000 PSI - Tipo Lungo	71
Curva BSP 90° cono 60° Dado Libero	27	Semiflange tagliate - 6000 psi	72
Curva BSP 45° cono 60°	28	Flangia Diritta SUPERCAT	72
Curva BSP 45° cono 60° - Dado rullato	28	Flangia 90° SUPERCAT	73
Curva BSP 45° cono 60° - Dado libero	28	Flangia 45° SUPERCAT	73
Compatta BSP 90° cono 60°	29	Flangia Komatsu diritta	74
Compatta BSP 90° cono 60° - Dado spinato - Welded	29	Flangia Komatsu 90°	74
Femmina BSP cono 60° con O-Ring	30	Flangia Komatsu 45°	74
Femmina BSP cono 60° con O-Ring - Dado Libero	30	Femmina JIS Cono 60° (Komatsu)	75
Curva BSP 90° cono 60° con O-Ring	31	Curva 90° JIS Cono 60° (Komatsu) - saldato	76
Curva BSP 90° cono 60° con O-Ring - Dado Libero	31	Femmina JIS cono 60° (Toyota)	76
Curva BSP 45° cono 60° con O-Ring	32	Curva JIS 90° (Toyota) - saldato	77
Curva BSP 45° cono 60° con O-Ring - Dado libero	32	Femmina JIS cono 60° (Nissan)	77
Maschio BSP svas. 60°	33	Femmina Metrica Cono 24° Serie Francese	78
Maschio NPTF svas. 60°	34	Femmina Tipo 'K' per Idropultrici	78
Maschio NPTF Svas.60° - girevole	35	Inserti Tipo 'K' (per lancia) - Diametro 10	79
Femmina NPSM cono 60° dado rullato	35	Inserti Tipo 'K' (per lancia) - Diametro 11	79
Maschio JIC cono 74°	36	Occhio a Pressare BSP	80
Femmina JIC svas. 74°	37	Bullone forato Gas Doppio	81
Femmina JIC svas. 74° - Dado Rullato	37	Bullone forato Gas	81
Femmina JIC svas. 74° - Dado libero	37	Occhio a Pressare Metrico	82
Femmina JIC svas. 74° - Doppio esagono	38	Bullone forato Metrico	83
Curva JIC 90° svas.74°	39	Giunzione per Tubi Flessibili	84
Curva JIC 90° svas.74° - Dado rullato	39	Gambo a Saldare	85
Curva JIC 90° svas.74° - Dado libero	39	<b>Inserto N</b>	<b>86</b>
Curva JIC 45° svas.74°	40	Boccola a Pressare 4WS (non skive)	90
Curva JIC 45° svas.74° Dado Rullato	40	Boccola a Pressare (non skive)	90
Curva JIC 45° svas.74° Dado libero	40	Maschio NPTF svas. 60°	91
Curva JIC 90° svas.74° - ISO SHORT	41	Maschio BSP svas. 60°	91
Compatta JIC 90° svas.74° - Dado crimpato	41	Femmina BSP cono 60°	92
Maschio SAE O'R Sede Piana	42	Curva BSP 90° cono 60°	93
Maschio Metrico svas. 24° Serie Leggera	43	Curva BSP 45° cono 60°	94
Femmina Metrica cono 24° Serie Leggera	44	Maschio Metrico svas. 24° Serie Leggera	95
Curva Metrica 90° cono 24° Serie Leggera	45	Femmina Metrica cono 24° Serie Leggera	96
Curva Metrica 45° cono 24° Serie Leggera	46	Curva Metrica 90° cono 24° Serie Leggera	96
Maschio Metrico svas. 24° Serie Pesante	47	Curva Metrica 45° cono 24° Serie Leggera	97
Femmina Metrica cono 24° Serie Pesante	48	Maschio Metrico svas. 24° Serie Pesante	97
Curva Metrica 90° cono 24° Serie Pesante	49	Femmina Metrica cono 24° Serie Pesante	98

## Indice Sezioni

Curva Metrica 90° cono 24° Serie Pesante .....	98	Maschio NPTF svas. 60° .....	139
Curva Metrica 45° cono 24° Serie Pesante .....	99	Femmina Metrica cono 24° Serie Pesante .....	139
Maschio JIC cono 74° .....	100	Curva Metrica 90° cono 24° Serie Pesante .....	140
Femmina JIC svas. 74° - Doppio esagono .....	101	<b>Raccordi bassa pressione</b> .....	<b>141</b>
Curva JIC 90° svas.74° .....	102	Femmina BSP cono 60° - UniLock .....	143
Curva JIC 90° svas.74° - ISO SHORT .....	102	Curva 90° BSP cono 60° - UniLock .....	143
Curva JIC 45° svas.74° .....	103	Boccola in Acciaio .....	144
Maschio ORFS .....	104	Maschio BSP - Sede Piana .....	145
Femmina ORFS doppio esagono .....	104	Maschio BSP svas. 60° .....	146
Curva ORFS 90° .....	105	Femmina BSP cono 60° .....	147
Curva ORFS 90° - ISO SHORT .....	105	Curva 90° BSP cono 60° .....	148
Curva ORFS 45° .....	106	Curva 45° BSP cono 60° .....	149
Flangia Diritta SAE 3000 PSI .....	106	Occhio a Pressare Metrico .....	150
Flangia 90° SAE 3000 PSI .....	107		
Flangia 45° SAE 3000 PSI .....	107		
Flangia Diritta SAE 6000 PSI .....	108		
Flangia 90° SAE 6000 PSI .....	108		
Flangia 45° SAE 6000 PSI .....	109		
Flangia Diritta SUPERCAT .....	109		
Flangia 90° SUPERCAT .....	110		
Flangia 45° SUPERCAT .....	111		
<b>Inserto Interlock</b> .....	<b>112</b>		
Boccola a Pressare (skive) .....	116		
Boccola a Pressare (skive) .....	116		
Boccola a Pressare (skive) .....	117		
Boccola a Pressare (skive) .....	117		
Maschio NPTF svas. 60° .....	117		
Maschio BSP svas. 60° .....	118		
Femmina BSP cono 60° Dado Spinato .....	118		
Curva BSP 90° cono 60° Dado Spinato .....	119		
Maschio JIC cono 74° .....	119		
Femmina JIC svas. 74° Dado Spinato .....	120		
Curva JIC 45° svas. 74° Dado Spinato .....	120		
Maschio Metrico svas. 24° Serie Pesante .....	121		
Femmina Metrica cono 24° Serie Pesante .....	121		
Curva Metrica 90° cono 24° Serie Pesante .....	122		
Curva Metrica 45° cono 24° Serie Pesante .....	122		
Maschio ORFS .....	123		
Femmina ORFS doppio esagono .....	123		
Curva ORFS 90° .....	124		
Curva ORFS 45° .....	124		
Flangia Diritta SAE 3000 PSI .....	125		
Flangia 90° SAE 3000 PSI .....	125		
Flangia 45° SAE 3000 PSI .....	126		
Flangia Diritta SAE 6000 PSI .....	127		
Flangia 90° SAE 6000 PSI .....	128		
Flangia 45° SAE 6000 PSI .....	129		
Flangia Diritta SUPERCAT .....	129		
Flangia 90° SUPERCAT .....	130		
Flangia 45° SUPERCAT .....	130		
Giunzione per Tubi Flessibili .....	131		
<b>Inserto Hyblast / Multispiral</b> .....	<b>132</b>		
Boccola a Pressare (skive) .....	135		
Boccola a Pressare (skive) .....	135		
Boccola a Pressare (skive) .....	135		
Femmina BSP cono 60° Dado Spinato .....	136		
Maschio NPTF svas. 60° .....	136		
Femmina Metrica cono 24° Serie Pesante .....	137		
Boccola a Pressare (skive) .....	137		
Femmina JIC svas. 74° Dado Spinato .....	138		
Curva JIC 90° svas. 74° Dado Spinato .....	138		
Femmina BSP cono 60° Dado Spinato .....	138		
Curva BSP 90° cono 60° Dado Spinato .....	139		



# INTERPUMP

FLUID SOLUTIONS 

Powered by I.M.M. Hydraulics



**I.M.M. Hydraulics Spa**  
[interpumpfluidsolutions.com](http://interpumpfluidsolutions.com)

Via Italia, 49-51  
66041 - Atessa (Ch) - Italy  
T. +39 (0) 0872 889225  
F. +39 (0) 0872 889226

